

Salamander Pumps



Quality | Technology | Service | Value

Pump installation and warranty guide for the CT range of pumps

CT FORCE 15 PT, 15 TU, 15 IPT, 15 ITU
20 PT, 20 TU, 20 IPT, 20 ITU
20 PS, 20 SU, 20 IPS, 20 ISU
30 PT, 30 TU, 30 IPT, 30, ITU
30 PS, 30 SU, 30 IPS, 30 ISU

CT Xtra 50, 50+, 54
55, 55+, 59
75, 75+, 79
85, 85+, 89



Models shown:
CT FORCE 15PT
CT 50 Xtra

Making
water
perform

WRAS
APPROVED
PRODUCT

Pump installation and warranty guide for the CT range of pumps

Important - read this first!

Correct installation is the guarantee of safety and a trouble free system. It is therefore important to read these instructions thoroughly and ensure you comply with them. Incorrect fitting will invalidate the warranty.

If your installation is complicated or you have any questions please CONSULT THE PUMPWISE TECHNICAL HELPLINE IMMEDIATELY on 0191 516 2002.

We encourage installers to consult Salamander's PumpWise helpline, where our engineers can give you first-rate advice regarding installation. Consulting the helpline will entitle your customer to an additional two years warranty FREE (UK only) for CT FORCE pumps and an additional 1 year warranty FREE (UK only) for CT Xtra pumps – all you have to do is to implement our engineer's recommendations for your installation situation and ask your customer to register.

Separate from this installation manual is a pre-paid warranty card with 3 years warranty for CT FORCE and 2 years warranty for CT Xtra (2 years as standard on both ranges in ROI). Don't forget that if you have called our helpline you should also complete the comments section of the card to say how you rate the service you received.

Please leave this instruction booklet with the customer for reference to maintenance and safety information.

Thank you for choosing Salamander Pumps.

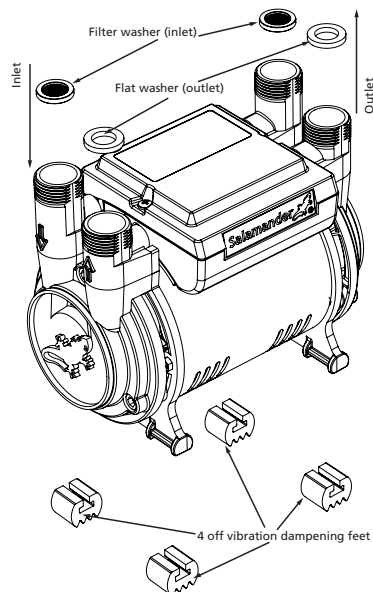

Contents

CT FORCE range of pumps	
CT Xtra range of pumps	
Product description	4
Installation instructions	4
Step 1: Pump location	6
Step 2: Connecting the pump	10
Step 3: Electrical installation	11
PumpWise Guidelines	12
General specifications	17
Technical specifications	19
Trouble shooting	21
Salamander PumpWise	22
Warranty	23

Pre-installation Checklist

Our pre-installation guidelines are detailed on the following pages, but some of the key “do’s and don’ts” are highlighted below:

Do’s

- Locate the pump next to the hot water cylinder within 5m. For pumps with 15mm couplers, 2m MAX of 15mm pipework on inlet connections may be used.
- Allow 100mm on all sides for ventilation
- Ensure pump is protected from frost
- If servicing two or more bathrooms, cold water supply to the cylinder must be in 28mm pipework
- Ensure adequate cold water storage 227 litres (50 gal) per bathroom, 364 litres (80 gal) for one bathroom and one en-suite)
- Cold water supplies to the pump must be taken from the opposite side of the cold water storage cistern to the cold water mains inlet
- Multiple cold water storage cisterns must be linked in accordance with current plumbing regulations and the bottom of the cisterns must be at the same level
- Hot water supply to the pump must be via a Salamander approved method.
- AV couplers must only be finger tight plus one quarter turn
- The maximum static head should be 10m (equivalent to 1.0bar pressure)
- We recommend the pump is activated for at least 5 minutes every 4 weeks to ensure pump does not seize.
- Ensure that installation complies with IET wiring regulations.
- All AV hoses should be fitted straight with no twists or bends.
- Ensure suitable means of isolation for maintenance
- Bathroom Zones: Salamander products covered in these notes cannot be installed in Zone 0 or Zone 1. They can however be installed in areas that are accessible with a tool. (see Step 1 Pump Location for further information (Fig 5)

Pre-installation Checklist *(continued)*

Don'ts

- Never fit the pump to the cold water mains
- Never fit the pump to shared incoming mains supplies to a block of flats
- Never use a shared water supply
- Never put a non-return valve (NRV), restrictive ballofix or an air vent on supply pipe work to the pump
- The hot water supply must not exceed temperature stated in the installation guide
- Never use mechanical tools to tighten plastic coupler nuts as this may cause damage and invalidate your warranty
- Never use jointing compounds, Boss White, Hemp or steel wool
- Solder fluxes must not come into contact with the pump or AV couplers
- Never pump directly to or from any pump such as secondary return pump
- Never fit pump to a Fortic, Primatic cylinder or Andrews type water heater.
- If considering fitting pump to a Horizontal (torpedo) water cylinder then please contact PumpWise on 0191 516 2002

Product Description

Salamander pumps are suitable for pressure boosting vented stored water systems but please note that inlet pressures to the pump and water temperatures must not exceed values stated in the technical specifications.

Installation instructions

Please follow these installation instructions carefully. Failure to install your pump in accordance with these instructions will invalidate your warranty. Any queries should be directed to PumpWise on 0191 516 2002.

Do not use Salamander pumps for applications other than those stated within the pump description, or connect the pump directly to the cold mains. To do so invalidates the warranty.

Salamander pumps should be installed by a competent person and supervision in their use should be given to children or anyone with impaired physical or mental capabilities

Please note that:

- FORCE 15 PT, 15 IPT, 20 PT, 20 IPT, 20 PS, 20 IPS, 30 PT, 30 IPT, 30 PS & 30 IPS, and CT Xtra 50, 50+, 54, 55, 55+, 59, 75, 75+, 79, 85, 85+, & 89 are shower specific pumps.
- FORCE 15 TU, 15 ITU, 20 TU, 20 ITU, 20 SU, 20 ISU, 30 TU, 30 ITU, 30 SU & 30 ISU are universal pumps.
- Inlets and outlets must be vertical and plumbed appropriately.

It is essential to ensure that: The cold stored water capacity is adequate for the entire household requirements (eg minimum 136 litres (30 gal) for shower only, 227 litres (50 gal) per bathroom, or 364 litres (80 gal) for one bathroom plus an en-suite shower room).

There is a maximum static head of 10 metres (100kPa/1.0Bar).

Cold supplies to the cylinder and the pump are taken from the opposite side of the cold water storage cistern to the cold mains inlet. The bottom of the cold water storage cistern must also be checked and cleared of debris (Figure 1).

Figure 1: Tank inlet and outlet position

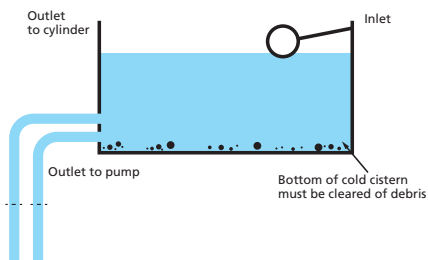

In systems with more than two bathrooms, the cold water supply to the cylinder must be in 28mm pipework.

Multiple cold water storage cisterns must be linked in accordance with the current plumbing regulations with the bottom of the cisterns level.

Never put a non-return valve, restricted ballcock or an air vent on the supply pipework to the pump

Figure 3: Hot water supply method

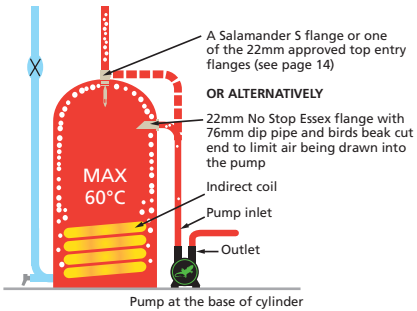

The stored hot water temperature must not exceed 60°C.

Ensure that the hot supply to the pump is via a Salamander approved method. (Figure 3)

Jointing compounds (boss white, hemp and steel wool) must not be used. Solder fluxes must not come into contact with the pump.

The anti-vibration hoses must not be twisted or bent.

Higher rated fuses must not be used.

Figure 4: Anti-gravity loop

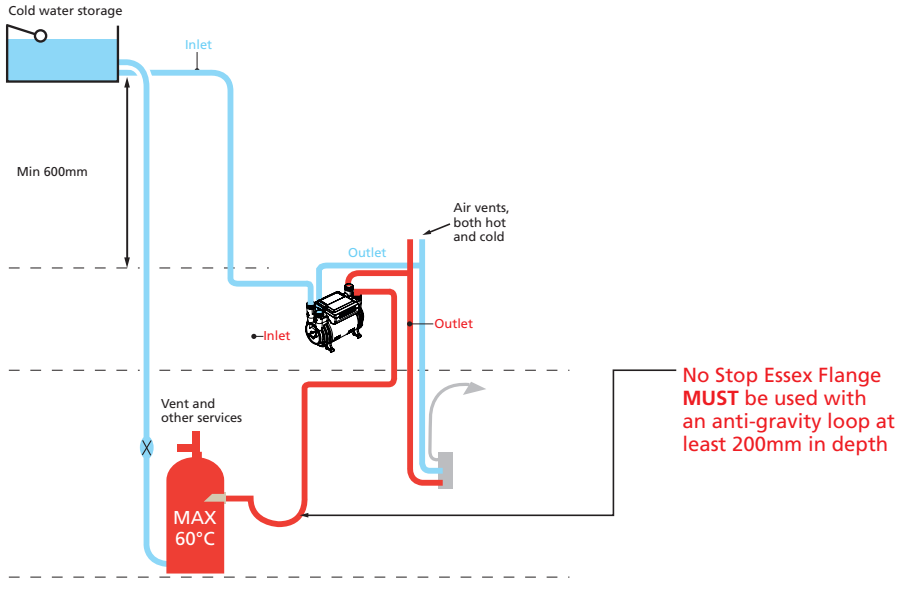

Step 1: Pump location

1. Site the pump in a location where it will not freeze or be exposed to frost during cold weather.
2. Ensure adequate airflow to cool the motor. Separate the pump from other appliances that generate heat. Install the pump in a clear space allowing 100mm at each side, end and top.
3. Care must be taken not to endanger pre-existing electrics when siting your Salamander pump
4. Ensure the pump is as close to the hot water cylinder as possible & no more than 5m in measured pipework away.
5. Mount the pump upright (shaft horizontal, not screwed down).
6. An anti-gravity loop (Figure 4) off a NO STOP ESSEX flange MUST be fitted to all systems where the pump is mounted above the hot outlet from the cylinder.
7. Bathroom Zones: Salamander products covered in these notes cannot be installed in Zone 0 or Zone 1. They can however be installed in areas that are accessible with a tool. (See figure 5)

The pump should be installed in accordance with BS7671:2008, it should also be noted that BS7671:2008 is a guide.

In BS7671:2008 rooms containing baths or showers should be broken down into zones.

These zones are summarised as:

ZONE 0 – This is the bath or shower tray

ZONE 1 – Is considered to be the area where the individual is bathing or showering or the area where shower water is likely to be directly sprayed.

ZONE 2 – Is the area beyond Zone 1, extending by a further 600mm.

Please refer to BS7671:2008 for further guidance.

8. Check the marker arrows on the pump to ensure correct direction of water flow. Either end of the pump is suitable for hot or cold water.
9. Check the static inlet pressure does not exceed 10m max (1.0bar/100kPa) of water above the pump.

Figure 5: Bathroom Zones

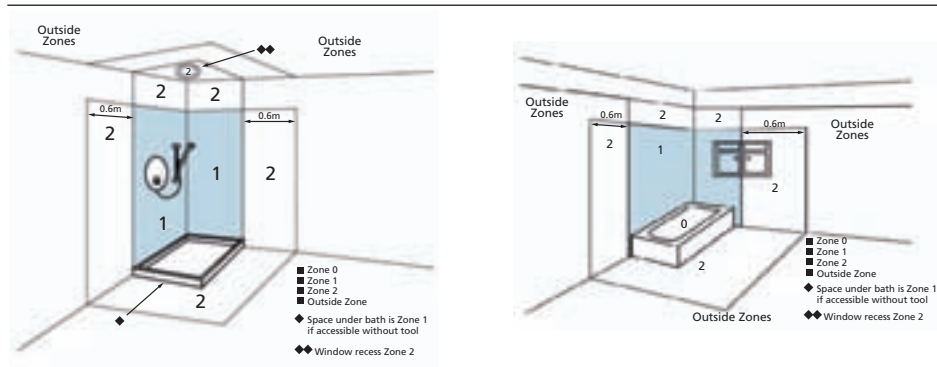

10. The hot supply pipework to the pump should be a maximum length of 5 metres in 22mm pipe (hot and cold supplies should be no more than 2 metres in 15mm pipe).
11. Exclusive hot and cold supplies to the pump with the hot from a Salamander approved method. Exceptions, only when pump is at the base of the cylinder or within 5m, are:
 - hot supply—from the vent angled at 45°, vertically down the hot connection at the vent, at least 1.5 metres below the base of the cold water storage cistern (Figure 6).
 - alternatively, the hot and cold supplies to the pump can be teed off other 22/28mm supplies (Figure 7) provided that:
 - the tee off to the pump is first call on the downward leg after the vent connection.
 - the cold supply to the pump is not shared with the cold feed to the cylinder.
12. The best hot connection from the cylinder (figure 3) is either with:
 - a ¾ inch no stop Essex flange, or a Salamander S flange or other approved top entry flange is fitted.
13. If pump is fitted above cylinder, a No Stop Essex flange must be used.
14. Check that water storage capacity recovery meets required flow rates, particularly at peak demand (i.e. appliances in simultaneous use).
15. All up and over pipework must be vented at the highest point on the outlet of the pump.
16. Ensure that pipe runs minimise airlocks.
17. In positive head systems, allow for increased resistance of long pipe runs with multiple bends. The natural flow from the shower head or other outlets must be at least 2litres/minute at all times. Any supply where the natural flow is less than 2litres/minute is classed as a negative head situation.

Figure 6. Exclusive hot and cold supply

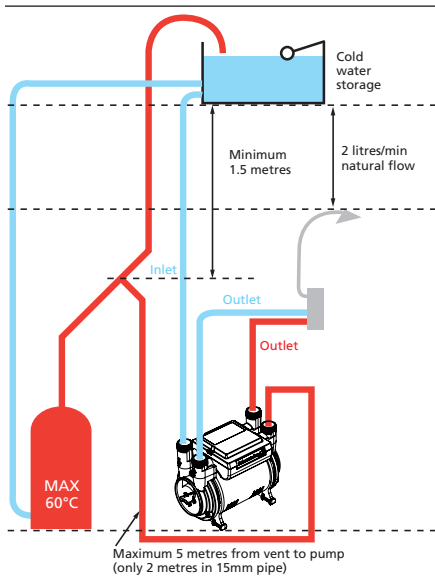
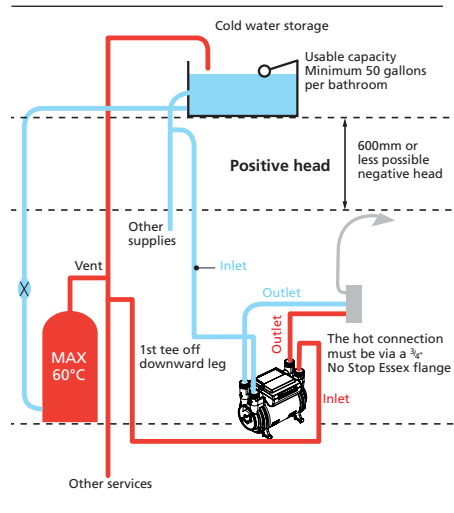

Figure 7. Tee off other supplies



Negative head systems

Negative head systems exist where no natural flow of water goes to the outlet because either the outlet or the pipework to the outlet are above the height of the base of the cold water cistern. Most instances of negative head systems occur in loft conversions or where the cold water cistern sits on the joists in the loft. If the distance between the bottom of the cold water cistern and the highest point in the system after the pump is 2 feet (610mm) or less, it is also possible that a universal pump will be required. Salamander's universal range of pumps activate the pump automatically even where no natural flow exists.

UK CT FORCE pumps suitable for negative head operation are:
CT FORCE 15 TU, 20 TU, 20 SU, 30 TU and 30 SU.

Irish CT FORCE pumps suitable for negative head operation are:
CT FORCE 15 ITU, 20 ITU, 20 ISU, 30 ITU and 30 ISU.

Figure 8. Negative head system

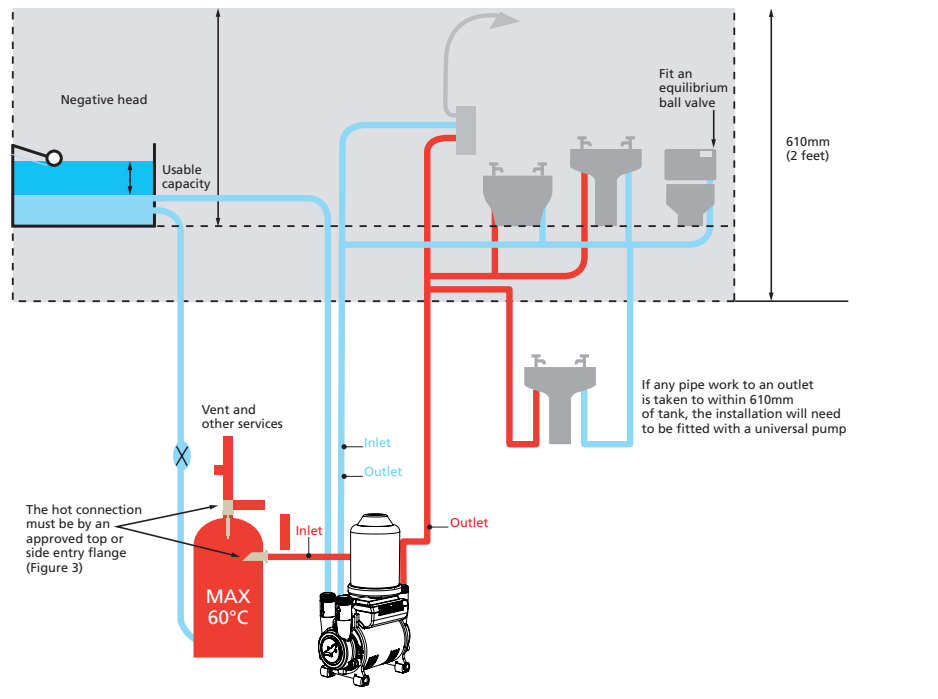

Commissioning



Before you finish

Fit pump inlet filters and vibration dampening feet.

It is CRITICAL to discharge water through the pump into a container using natural flow before connecting the pump to outlet pipework in order to ensure the air has been discharged from inlet pipework and pump chambers. This will not happen if the outlet pipework is connected to the pump. The best method is:-

- Connect discharge pipework, not outlet pipes.

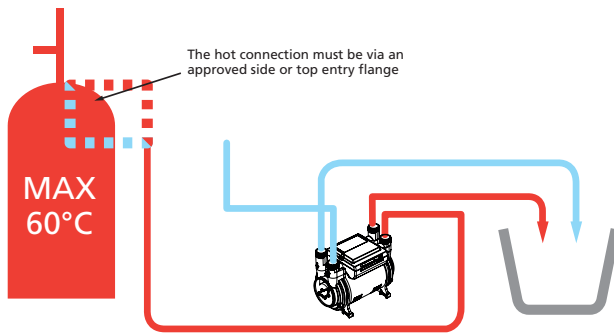

- **Check that all the AV coupler isolating valves are open.**
- Fill system. Check for leaks.
- **DO NOT RUN PUMP DRY – to do so will cause irreparable damage to your pump and will invalidate your warranty.**
- Open shower mixer valve/system outlets to maximum hot and cold to check the natural flow (unpumped) MUST be at least 1 litre in 30 seconds per side and 2 litres in 1 minute mixed.
- Open hot water outlets fully for 5 to 6 seconds and then turn outlets off. Then open cold water outlets fully for 5 to 6 seconds and turn outlets off. If flow is poor and inconsistent repeat above steps until flow is steady.

Repeat 2-3 times

Step 2: Connecting the pump

Use only Salamander supplied AV couplers to connect the pump.

All associated pipework **MUST** be thoroughly flushed before making final connections to the pump. Fill the pump with water before connecting to the discharge pipework.

! The in-line strainers must be fitted to the hot and cold inlet supplies to the pump.

A Hose to pipework

The anti-vibration coupler nuts need only be finger tight plus one quarter turn. Mechanical tools must not be used to tighten plastic coupler nuts as this may cause damage which will invalidate the warranty.

B Hose to pump

Do not twist or bend anti-vibration hoses as this will invalidate the warranty.

Ensure that there are suitable means of isolation for maintenance

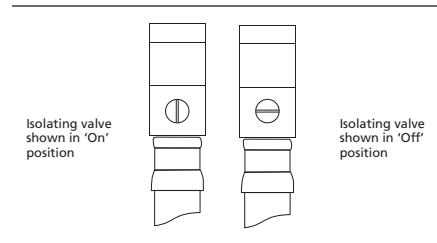

! Filter washers MUST be fitted to the inlets of the pump to validate your warranty. Flat washers must be fitted to the outlets. Flat and filter washers are supplied with the pump.

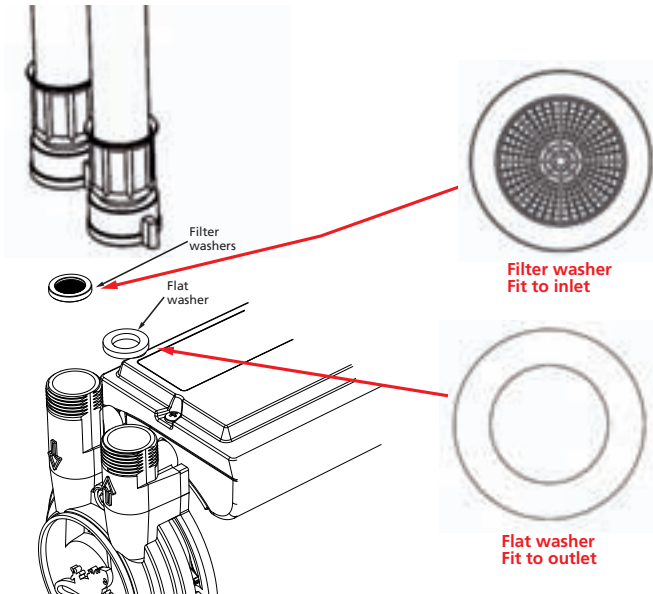

Step 3: Electrical installation

Your pump must be connected to the electrical supply using the main cable with the attached plug. This plug must be connected to an accessible socket that has been installed in compliance with IET Wiring Regulations.

The Plug must be accessible at all times.

If the supply cord is damaged, it must be replaced by the manufacturer, it's service agent, or similarly qualified person in order to avoid a hazard.

All pipe work must be cross-bonded in accordance with the IET Regulations.

The pump is supplied with a fuse fitted. Higher rate fuses **MUST NOT** be used.

If installed by a Part P qualified installer, the pump may be fitted via a fused mains spur without invalidating the warranty. See Technical Specifications for fuse ratings for each model of pump. Ensure that the pump is fully operational before hard wiring pump in this instance, this should be done during commissioning.

Helpful Pumpwise guidelines

Cold water supplies and storage Recovery of cold storage

Ensure that there is sufficient water recovery to cover the water usage by the appliance

Aeration of pump and cylinder from a cold water storage cistern

This occurs when the incoming cold mains ball valve is positioned above the cold feeds to the cylinder and to the pump – aerated water is drawn into the pump as illustrated.

Figure 9: Aeration

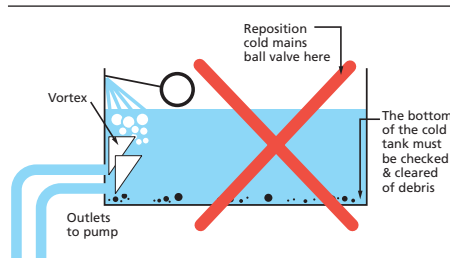

Chronic aeration of the pump occurs when this problem is combined with inadequate storage capacity and/or when the volume of water is drawn by the pump and other services exceeds the refill rate and creates a vortex which draws air and possibly debris into the pump.

Water starvation protection

In systems where it is absolutely not possible to increase the usable cold water storage capacity to meet the increased demand of a pumped system; a water starvation protection unit (WSP) may be considered (See fig 11).

The WSP is a Salamander level switch which must be positioned 102mm higher than the highest outlet from the cold water storage cistern. When the water level drops too far the WSP will switch off the pump until the cold water storage level is recovered.

Cold storage usable capacity

The usable capacity of cold storage is easily calculated as the capacity of water in the cold cistern above the cold feeds to the cylinder, the pump and other outlets – see formula.

Figure 10: Water capacity calculations

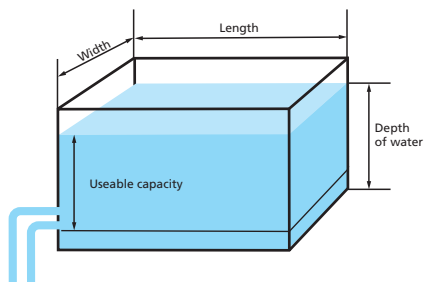

Formula for calculation on rectangular cistern:

Water above inlet (15") x width (23")
x length (36") = 12,420 cu inches

Volume cu inches (12,420) x 0.01639
= 203.56 litres

Volume litres (203.56) x 0.22 = 44.78 gallons

Figure 11: Water starvation protection unit (WSP)

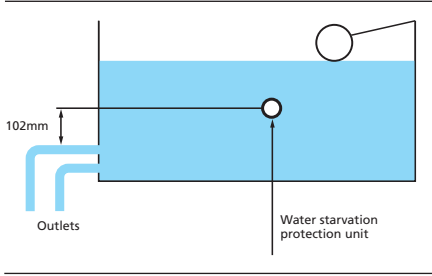

Anti-gravity loops

An anti-gravity loop (AGL) must always be fitted to systems where the pump is positioned above the dome of the cylinder (see fig 12). The AGL which limits aeration of the hot supply to the pump is formed by bending the pipework downwards for 250mm, as it exits the No Stop Essex flange, before rising again to the pump. (See figure 14).

Combi boilers and water heaters

As these appliances are invariably supplied directly from the cold mains – they are not suitable for this range of pumps, unless pumping from a cold water storage cistern via a universal pump.

Horizontal cylinders

As horizontal (Torpedo) cylinders are problematic for boosted systems consult PumpWise on 0191 516 2002 for guidance and correct use of an approved top entry flange.

S flange

Complete with compression pump outlet and the open vent connections. Also supplied with an adaptor to connect to 1" male and female top entry cylinders. (See fig 13).

Figure 12: Anti-gravity loop (AGL)

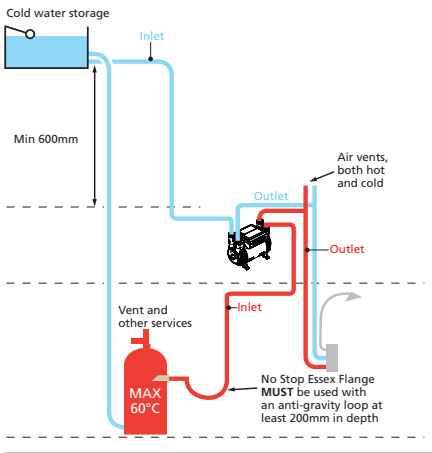
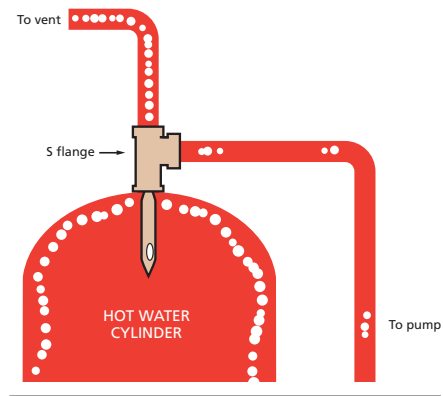

Figure 13: S flange



Approved flanges (cylinders)

The 22mm No Stop Essex and the other approved top entry flanges with extension pipes into the cylinder represent the best known means of ensuring minimal aeration of the hot supply water to the pump.

Please contact PumpWise on 0191 516 2002 for additional approved flanges.

Warix flange

- The vent connection **MUST** be from side in Warix flange.
- The supply connection to the pump **MUST BE FROM THE TOP** of the Warix flange.
- In systems where there are one bathroom and an en-suite shower, or two or more bathrooms, the cold feed to the cylinder **MUST** be in 28mm pipework.

Figure 14: Approved flanges

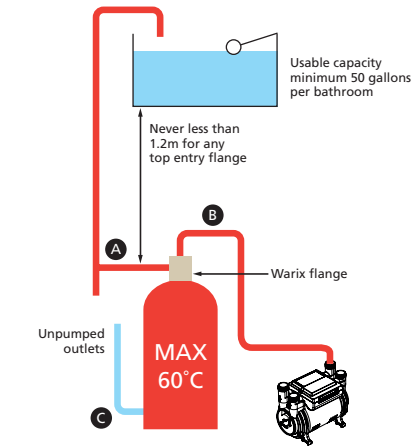

Water hammer protection

Water hammer most commonly occurs in systems where there are long pipe runs supplying solenoid activated appliances e.g. washing machines or outlets with quick acting/turn taps/valve(s). The harmful effect of water hammer shock waves can be cushioned by fitting a pressure vessel unit, into the supply pipework as close as possible to the outlet from which the shock waves are originating.

Figure 15: Water hammer protection

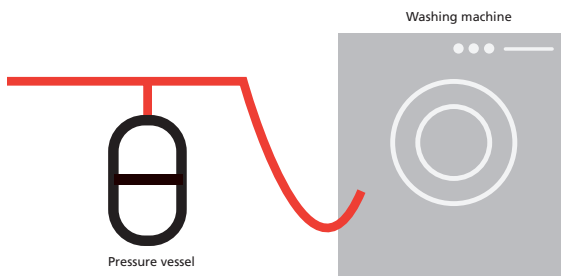

Pump hunting protection

In negative head systems all the discharge pipework after the pump is pressurized. In such systems there exists the possibility the pump will hunt ON-OFF-ON etc at intervals.

This will happen:

- if all outlets are not fully closed
- if there is a leak at a connection
- if boosted toilets are not fitted with equilibrium ball valves
- or as residual hot water contracts in long pipe runs.

Stored hot water volume

In calculating the volume of the stored hot water requirement it is important to consider:

- number of bathrooms, with particular attention to the size of the bath
- number of persons in household

Stored hot water temperature

Extract from BS5546:1990 (Current)

“The mean temperature of the stored water should not normally exceed 60°C and in a combined central heating and domestic hot water system it is recommended that the stored water temperature is controlled independently from that on the primary circuit”.

Extract from BS6700:1997

“Under normal conditions the temperature of stored hot water should never exceed 65°C. A stored hot water temperature of 60°C is considered sufficient to meet all normal requirements and will minimise scale deposits in hard water areas”.

Effective control of stored hot water is simply achieved by use of a cylinder thermostat or direct acting thermostatic valve (e.g. tapstat).

Maximum water temperature for CT Xtra & CT FORCE pumps is 60°C.

In systems where the stored hot water temperature cannot be controlled e.g. Aga solid fuel appliance or very crudely by the boiler thermostat, a HWS Blending Valve Controller or a TMV must be used.

HWS TMV blending valve controller

The HWS Blending valve controller will protect booster pumps in systems where the temperature of the stored hot water is uncontrolled – see below.

Figure 16: HWS blending valve controller to pump

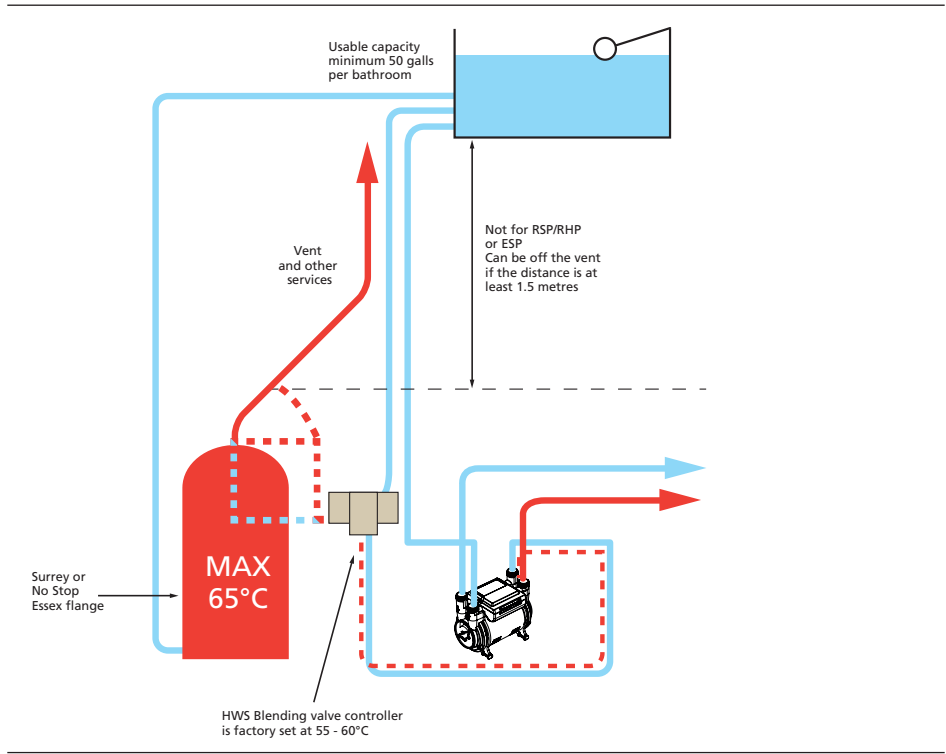

General specifications – CT FORCE

Applications

All Salamander pumps are designed to boost low pressure hot and cold supplies from cistern-fed services. When supplies from a water heater or a combination boiler are to be boosted contact the Salamander PumpWise helpline on 0191 516 2002 for guidance.

Voltage

230 volts, 50 Hz.

Motor type

Capacitor start and run induction type motor with stainless steel shaft and in-built resetting thermal protection (complies with BS5000 part 11).

Maximum head

All Salamander CT FORCE pumps – 10 metres (100kPa/1.0Bar).

Anti-vibration couplers

Do not bend

Complete with CT FORCE Pumps are supplied with AV couplers Push Fit connections and built-in isolating valves. See Technical specifications for details.

Mechanical seals

Rotary mechanical face seals are used. Scale deposits in water supplies can cause the mechanical seal to stick if left for long periods without use. The pump must be run at least five minutes every four weeks to 'exercise' all working parts.

Connections

$\frac{3}{4}$ " BSP male.

Initiation

Fully automatic, flow operated, requiring 1ltr in 30 sec per side or 2ltr in 30 sec mixed.

Only applies to positive head pumps.

Temperature

Maximum fluid temperature 60°C.

Pump noise

Salamander has engineered this product range to be as quiet as possible, however no pump is completely silent. Correct installation (anti-vibration couplers straight, rubber feet fitted) will minimise noise, vibration and transmission noise.

Standards and approvals

Splash proof rating IPX2; complies with the requirements of current British and European safety standards for household and similar electrical appliances; meets with Compliance with European Community Directives (CE). Due to continuous improvement and updating specifications may be altered without prior notice.



The CT FORCE range is also fully WRAS approved.

General specifications – CT Xtra

Applications

All Salamander pumps are designed to boost low pressure hot and cold supplies from cistern-fed services. When supplies from a water heater or a combination boiler are to be boosted contact the Salamander PumpWise helpline on 0191 516 2002 for guidance.

Voltage

230 volts, 50 Hz.

Motor type

Capacitor start and run induction type motor with stainless steel shaft and in-built resetting thermal protection (complies with BS5000 part 11).

Maximum head

All CT Xtra pumps are rated for a maximum static head of 10 metres.

Anti-vibration couplers

Do not bend

Please refer to the Technical Specifications table for information on which AV Couplers are supplied with each pump.

Mechanical seals

Rotary mechanical face seals are used. Scale deposits in water supplies can cause the mechanical seal to stick if left for long periods without use. The pump must be run for at least five minutes every four weeks to 'exercise' all working parts.

Connections

$\frac{3}{4}$ " BSP male.

Initiation

Fully automatic, flow operated, requiring 1 litre in 30 sec per side or 2 litres in 30 sec mixed.

Temperature

Maximum fluid temperature 60°C.

Pump noise

Salamander has engineered this product range to be as quiet as possible, however no pump is completely silent. Correct installation (anti-vibration couplers straight, rubber feet fitted) will minimise noise, vibration and transmission noise.

Standards and approvals

Splash proof rating IPX2; complies with the requirements of current British and European safety standards for household and similar electrical appliances; meets with Compliance with European Community Directives (CE). Due to continuous improvement and updating specifications may be altered without prior notice.

The CT Xtra range of pumps is also fully WRAS approved.



Technical specifications – CT FORCE

Part No.	Description	Specification			Performance			Connection Type			Pump Volumetrics				Packed Pump Volumetrics			
		Electrical Input	Fuse	Pump Type	Pressure (kPa/Bar) at 16ltr/min	Pressure (kPa/Bar) at 8ltr/min	Max pressure (kPa/Bar) closed head	Pump	Hoses	Isolators	Dimensions				Dimensions			
											Regenerative	BSP	Push fit	Isolators integrated into the hoses	Weight (Kg)	Length (mm)	Width (mm)	Height (mm)
CT FORCE																		
FORCE 15 PT FORCE 15 IPT	1.5 Bar Twin End Positive Head Shower Pump	✓	3A	✓	100 (1.0)	130 (1.3)	150 (1.5)	¾"	22mm 21mm	✓	4.50	190	120	165	5.56	295	215	205
FORCE 20 PT FORCE 20 IPT	2.0 Bar Twin End Positive Head Shower Pump	✓	3A	✓	130 (1.3)	170 (1.7)	200 (2.0)	¾"	22mm 21mm	✓	4.84	190	120	165	5.89	295	215	205
FORCE 30 PT FORCE 30 IPT	3.0 Bar Twin End Positive Head Shower Pump	✓	3A	✓	200 (2.0)	250 (2.5)	300 (3.0)	¾"	22mm 21mm	✓	6.37	220	120	165	7.43	295	215	205
FORCE 20 PS FORCE 20 IPS	2.0 Bar Single End Positive Head Shower Pump	✓	3A	✓	130 (1.3)	170 (1.7)	200 (2.0)	¾"	22mm 21mm	✓	4.22	190	120	165	5.27	295	215	205
FORCE 30 PS FORCE 30 IPS	3.0 Bar Single End Positive Head Shower Pump	✓	3A	✓	200 (2.0)	250 (2.5)	300 (3.0)	¾"	22mm 21mm	✓	5.75	220	120	165	6.80	295	215	205
CT FORCE																		
FORCE 15 TU FORCE 15 ITU	1.5 Bar Twin End Positive and Negative Head Shower Pump	✓	3A	✓	100 (1.0)	130 (1.3)	150 (1.5)	¾"	22mm 21mm	✓	5.20	190	130	295	6.32	295	215	365
FORCE 20 TU FORCE 20 ITU	2.0 Bar Twin End Positive and Negative Head Shower Pump	✓	3A	✓	130 (1.3)	170 (1.7)	200 (2.0)	¾"	22mm 21mm	✓	5.53	190	130	295	6.65	295	215	365
FORCE 30 TU FORCE 30 ITU	3.0 Bar Twin End Positive and Negative Head Shower Pump	✓	3A	✓	200 (2.0)	250 (2.5)	300 (3.0)	¾"	22mm 21mm	✓	7.07	220	130	295	8.19	295	215	365
FORCE 20 SU FORCE 20 ISU	2.0 Bar Single End Positive and Negative Head Shower Pump	✓	3A	✓	130 (1.3)	170 (1.7)	200 (2.0)	¾"	22mm 21mm	✓	4.92	190	130	295	6.03	295	215	365
FORCE 30 SU FORCE 30 ISU	3.0 Bar Single End Positive and Negative Head Shower Pump	✓	3A	✓	200 (2.0)	250 (2.5)	300 (3.0)	¾"	22mm 21mm	✓	6.45	220	130	295	7.56	295	215	365

Technical specifications – CT Xtra

Part No.	Description	Specification			Performance			Connection Type			Pump Volumetrics				Packed Pump Volumetrics			
		Electrical Input		Pump Type	Pressure (kPa/Bar) at 16ltr/min	Pressure (kPa/Bar) at 8ltr/min	Max pressure (kPa/Bar) closed head	Pump	Hoses	Isolators	Dimensions				Dimensions			
		230/1/50	Fuse	Regenerative				BSP	Push fit	Isolators integrated into the hoses	Weight (Kg)	Length (mm)	Width (mm)	Height (mm)	Weight (Kg)	Length (mm)	Width (mm)	Height (mm)
CT Xtra Shower Pumps																		
CT 50 Xtra	1.5 Bar Twin End Positive Head Shower Pump	✓	3A	✓	120 (1.2)	140 (1.4)	150 (1.5)	¾"	15mm	-	3.46	195	120	165	4.22	295	215	205
CT 50+ Xtra	1.5 Bar Twin End Positive Head Shower Pump	✓	3A	✓	120 (1.2)	140 (1.4)	150 (1.5)	¾"	15mm	✓ Inlet only	3.46	195	120	165	4.22	295	215	205
CT 54 Xtra	1.5 Bar Twin End Positive Head Shower Pump	✓	3A	✓	120 (1.2)	140 (1.4)	150 (1.5)	¾"	21mm	✓	3.46	195	120	165	4.22	295	215	205
CT 75 Xtra	2.0 Bar Twin End Positive Head Shower Pump	✓	3A	✓	150 (1.5)	170 (1.7)	200 (2.0)	¾"	15mm	-	3.78	195	120	165	4.55	295	215	205
CT 75+ Xtra	2.0 Bar Twin End Positive Head Shower Pump	✓	3A	✓	150 (1.5)	170 (1.7)	200 (2.0)	¾"	15mm	✓ Inlet only	3.78	195	120	165	4.55	295	215	205
CT 79 Xtra	2.0 Bar Twin End Positive Head Shower Pump	✓	3A	✓	150 (1.5)	170 (1.7)	200 (2.0)	¾"	21mm	✓	3.78	195	120	165	4.55	295	215	205
CT 55 Xtra	1.5 Bar Single End Positive Head Shower Pump	✓	3A	✓	120 (1.2)	140 (1.4)	150 (1.5)	¾"	15mm	-	3.37	195	120	165	4.01	295	215	205
CT 55+ Xtra	1.5 Bar Single End Positive Head Shower Pump	✓	3A	✓	120 (1.2)	140 (1.4)	150 (1.5)	¾"	15mm	✓ Inlet only	3.37	195	120	165	4.01	295	215	205
CT 59 Xtra	1.5 Bar Single End Positive Head Shower Pump	✓	3A	✓	120 (1.2)	140 (1.4)	150 (1.5)	¾"	21mm	✓	3.37	195	120	165	4.01	295	215	205
CT 85 Xtra	2.0 Bar Single End Positive Head Shower Pump	✓	3A	✓	200 (2.0)	230 (2.3)	250 (2.5)	¾"	15mm	-	3.38	195	120	165	4.02	295	215	205
CT 85+ Xtra	2.0 Bar Single End Positive Head Shower Pump	✓	3A	✓	200 (2.0)	230 (2.3)	250 (2.5)	¾"	15mm	✓ Inlet only	3.38	195	120	165	4.02	295	215	205
CT 89 Xtra	2.0 Bar Single End Positive Head Shower Pump	✓	3A	✓	200 (2.0)	230 (2.3)	250 (2.5)	¾"	21mm	✓	3.38	195	120	165	4.02	295	215	205

Trouble shooting

**CHECK THAT THE INSTALLATION COMPLIES WITH THE SALAMANDER INSTRUCTIONS
IF PUMP IS STILL INOPERABLE, CONTACT OUR TECHNICAL ADVICE LINE ON 0191 516 2002**

Fault	Probable cause	Recommended solution
Pump will not start	Insufficient gravity flow	Check suitability of pump – is installation in negative head (see page 8) Check inlet filters are not blocked Check flow rate min of 2l/min required on both hot and cold
	Inlet/outlet connections incorrect	Check that connections are plumbed the correct way round and all valves are open
	Electrical	Check power supply Check fuse Check circuit breaker
	Debris under flow switch	Remove outlet hoses and check that flow switch sits in lowest position
	Float sticking in outlet	Ensure no debris is in outlet area
	Flow switch malfunction	Contact service
Reduced/ intermittent flow	Incorrect or no anti-aeration flange fitted	Fit appropriate anti-aeration flange
	Insufficient gravity flow	See above
	Blocked inlet filters	Ensure that all filters and shower head are free from debris
	Couplers restricting flow	Ensure that all AV couplers are straight and not bent or distorted
	Air in system	Run system on full hot with pump switched off (i.e. gravity only) for several minutes Check cold water storage is correct for installation Ensure cold water refill rate is adequate for installation Check that vents are fitted as described in instructions
	Wrong size pump for system	Ensure pump is sufficient to run the equipment
	Hot temp set too high	Reduce cylinder stat setting to 60°C max or fit HWS/TMV
Pump starts with all outlets closed	Leak in system	Check for leaks
	Outlet open	Ensure all outlets are fully closed or capped – i.e. no dead legs in pipework
Pump is noisy	Air in system	See above
	Pump vibrating on surface	Ensure rubber feet are fitted to pump
	AV couplers causing vibration	Ensure that all AV couplers are straight and not bent or distorted
Pump is leaking	Pump exposed to mains water pressure	Fit break cistern or remove from mains supply
	Pump has suffered chemical damage	Ensure that the pump has not come into contact with chemical substance i.e. solder flux
	Pump exposed to excessive temperature	Is effective temp control fitted (cylinder stat or HWS/TMV valve)
	Pump appears to have leaked but not sure	Check leak is not from fitting in pipework above pump

Salamander PumpWise

Salamander PumpWise is your guarantee to:

- help you select the right pump for the job.
- avoid installation pitfalls.
- provide a further **TWO YEARS WARRANTY FREE for CT FORCE pumps** and a further **ONE YEAR WARRANTY FREE for CT XTRA pumps**. (UK only), in addition to the standard warranty period.

All you have to do is to implement the technical advice recommendations for any specific installation and register the pump when installation is complete.

PumpWise helpline 0191 516 2002

PumpWise from Salamander helps customers and provides a support service second to none. Installers and customers can be sure of a speedy response to requests for technical help guidance and advice.

Safety in operation

These appliances are not intended for use by persons (including children) with reduced physical, sensory or mental capabilities, or lack of experience and knowledge, unless they have been given supervision or instruction concerning use of the appliance by a person responsible for their safety.

Children should be supervised to ensure that they do not play with the appliance

Warranty

Salamander CT FORCE pumps benefit from a full three years warranty, and CT XTRA pumps benefit from a full two years warranty (2 years on both CT FORCE and CT Xtra in ROI). This is extended to five years (CT FORCE), or three years (CT Xtra) when customers consult us through the PumpWise initiative and register the pump when installation is complete (UK only).

PLEASE NOTE:

Incorrect installation WILL invalidate the pump warranty

Salamander Pumps operates a policy of continuous development and reserves the right to change any of the specifications of its products without prior notice. All information data and illustrations given in this leaflet may be subject to variation.

Your showering sensation for life

In order to continue enjoying the showering sensation brought to you by your Salamander Pump:

- complete and return the attached Warranty card
- take care that the temperature of your stored water NEVER exceeds the recommended maximum of 60°C
- contact the PumpWise helpline at any sign of aeration or spluttering of the discharge water from the shower or other outlets

Our PumpWise commitment

We promise to help you select the right pump and eliminate the risk of incorrect installation. We strive to design and manufacture a robust quality product that will delight our customers. We assure you that should you experience a problem the PumpWise helpline is there to help; our engineers will provide immediate advice and, if necessary, arrange to fix the problem on site.

Further technical assistance

For more details and further technical assistance consult PumpWise.

Telephone: 0191 516 2002
Facsimile: 0191 548 4445
E-mail: tech@pumpwise.co.uk



To the installer

Please follow the guidelines for installation provided in this brochure and call the PumpWise helpline for installation advice.

Once the installation has been completed and the system has been tested to your satisfaction, please assist the customer in completing the prepaid Warranty Card.

Please note that Salamander Pumps are able to provide an onsite service visit which may be chargeable.

1 The Scope of the Warranty

SALAMANDER PUMPED SHOWER SYSTEMS LTD ("the company") Warrants subject to the terms and conditions below for the Warranty period(s) specified in paragraph 3 that the Company shall:

Repair or replace free of charge the product(s) specified on the Warranty card or any component part thereof (together referred to as "the equipment") which shall in the opinion of the Company have proved defective by reason only of the Company's materials or workmanship providing always that the Company shall be under no obligation whatsoever under this Warranty to repair or replace equipment which shall have been misused modified altered or transformed in any way without the consent in writing of the Company or if any component or accessory shall have been replaced by a type not specified by the Company or if the equipment is incorrectly installed or operated or used other than as described in the instruction manual or if any servicing or repair of the equipment shall have been carried out otherwise than by an authorised Company dealer appointed by the Company ("dealer").

The Company's liability under this Warranty is limited to the said repairs or replacement and shall under no circumstances extend to any financial loss or damage including consequential losses alleged to have been suffered by the claimant.

Subject as provided in this warranty and except where the equipment is sold to a person dealing as a consumer all warranties, conditions or other terms implied by law are excluded to the fullest extent permitted by law.

Nothing in this warranty shall exclude liability for death or personal injury caused by the Company's negligence.

2 Terms and conditions

This Warranty shall only be enforceable by you if the following terms and conditions have been complied with:

- a. That the pump has been installed in accordance with the installation instructions, guidance and advice contained within the installation and warranty guide and/or provided by the Salamander help desk.
- b. You are the original purchaser of the equipment from a dealer and not an assignee or subsequent purchaser of the equipment.

- c. You must evidence the date of purchase by retaining the original invoice from the dealer. Without such evidence the Company reserves the right to reject any such claims under the terms of this Warranty.
- d. Within 15 days of delivery of the equipment to you the Warranty card is accurately completed and returned to the Company.
- e. Within thirty days of discovery of a defect giving rise to liability under paragraph 1 above you give notice thereof in writing to the Company.

3 The Warranty periods

The Warranty periods referred to in paragraph 1 above are as follows:

- a. i. CT FORCE (UK only) products manufactured by the Company 3 years from date of purchase provided the warranty card is completed and returned to the Company within 15 days of purchase.
- ii. CT FORCE (ROI only) products manufactured by the Company 2 years from date of purchase provided the warranty card is completed and returned to the Company within 15 days of purchase.
- iii. CT Xtra (UK & ROI) products manufactured by the Company 2 years from date of purchase provided the warranty card is completed and returned to the Company within 15 days of purchase.
- iv. Where the PumpWise helpline has been contacted, and the recommendations implemented, the warranty periods detailed in points 3.a.i. and 3.a.iii. will be extended by 2 years for the CT FORCE pump range to 5 years total (UK only), and by 1 year for the CT Xtra pump range to 3 years total (UK only).
- b. Products supplied by the Company, but not of the Company's manufacture 1 year from date of purchase.
- c. The warranty period in respect of any product repaired or replaced under the warranty shall be part of the above period(s) which remain unexpired.
- d. In the event of a claim for repairs or replacement being made under the terms of this Warranty in the circumstances where in the opinion of the Company the defect has not been caused by the Company's materials or workmanship then the Company reserves the right to charge the claimant at its current hourly rates and list prices in respect of any service engineer's time and any replacement of parts.
- e. This Warranty is given in addition to and does not affect your statutory rights as a consumer.
- f. This Warranty is valid and enforceable for equipment purchased and used exclusively in the UK and The Republic of Ireland only.
- g. Where the Company makes a replacement the equipment replaced shall be returned to the Company forthwith and shall become the property of the Company.
- h. No authority has been given to any person, firm or company to vary the terms of this Warranty.

2



Freeport RLXE-JHHY-HLHJ
Salamander Pumps
Unit 2c Colima Avenue
Sunderland
SR5 3XE



Salamander Pumped Shower Systems Limited
 Unit 2c Colina Avenue, Sunderland, SR5 3XE

Tel: 0191 516 2002
 Fax: 0191 548 4445
 Email: service@salamanderpumps.co.uk



Warranty card

Please supply the following information:

1 User name Address _____ _____ _____ Postcode _____ Tel No. _____		Date of purchase ____ / ____ / ____	Pump serial number _____	Model _____
2 Installer name Address _____ _____ _____ Postcode _____ Tel No. _____		7 What is the approximate distance in feet from the pump to the cylinder? Horizontal _____ Vertical _____		
3 I am interested in becoming part of Salamander's Trained Installer Network YES <input type="checkbox"/> NO <input type="checkbox"/>		8 What is the approximate cold water storage capacity in gallons? 25 <input type="checkbox"/> 40 <input type="checkbox"/> 50 <input type="checkbox"/> 70 <input type="checkbox"/> 100 <input type="checkbox"/>		
4 Supplier from whom system was purchased Name _____ Address _____ _____ Postcode _____		9 How is the hot water heated? Gas <input type="checkbox"/> Oil <input type="checkbox"/> Solid fuel <input type="checkbox"/> Aga <input type="checkbox"/> Electric <input type="checkbox"/>		
5 What does your pump boost? Shower <input type="checkbox"/> Multiple showers <input type="checkbox"/> Whole house <input type="checkbox"/> Other (please specify) _____		10 Does the DHWS cylinder have independent controls for: Zone YES <input type="checkbox"/> NO <input type="checkbox"/> Temperature YES <input type="checkbox"/> NO <input type="checkbox"/> What is the cylinder-stat setting? _____		
6 Where is the pump installed? Loft <input type="checkbox"/> Airing cupboard <input type="checkbox"/> Under bath <input type="checkbox"/> Other (please specify) _____		11 Who chose the pump? Householder <input type="checkbox"/> Plumber <input type="checkbox"/> Merchant <input type="checkbox"/> Showroom <input type="checkbox"/> Builder <input type="checkbox"/>		
13 How many shower pumps do you fit per month? Comments _____		12 Why did you choose a Salamander pump? _____		

I am interested in an extended warranty. **Please tick box**
 Please send details of the Extended Warranty Scheme and application form.