

Qty. Description

1 SP 1A-50



Note! Product picture may differ from actual product

Product No.: [08102E50](#)

Submersible borehole pump, suitable for pumping clean water. Can be installed vertically or horizontally. All steel components are made in stainless steel, EN 1.4301 (AISI 304), that ensures high corrosive resistance. This pump carries drinking water approval.

The pump is fitted with a 1.5 kW MS402 motor with sand shield, lip seal, water-lubricated journal bearings and a volume compensating diaphragm. The motor is a canned type submersible motor offering good mechanical stability and high efficiency. Suitable for temperatures up to 40 °C.

The motor is not fitted with a temperature sensor. If temperature monitoring is desired, a Pt1000 sensor can be fitted.

The motor is for direct-on-line starting (DOL).

Further product details

The pump is suitable for applications similar to the following:

- raw-water supply
- irrigation
- groundwater lowering
- pressure boosting
- fountain applications.

Pump

All pump surfaces that are in contact with pumped liquids are made in stainless steel which makes them corrosion- and wear-resistant. The corrosion diagram below shows the capabilities of the pump and motor in relation to the temperature in Celsius (y-axis) and the concentration of chloride in ppm (x-axis).

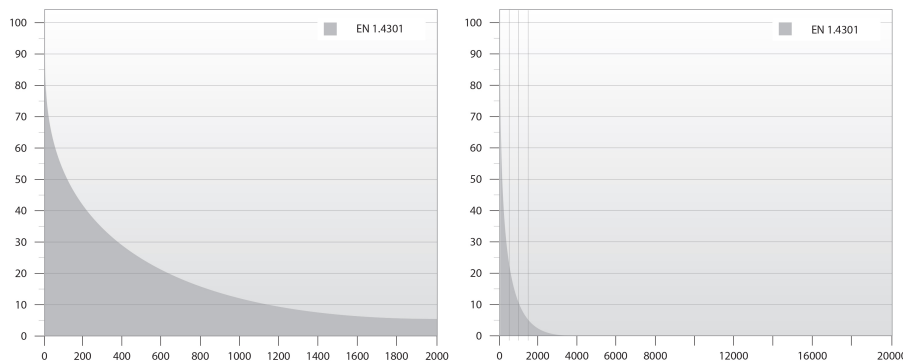

The elastomer parts in the pump are made of NBR (Nitrile-Butadiene Rubber) and TPU (Thermoplastic Poly-Urethane) which offers good wear resistance and long service intervals.

The suction interconnector is fitted with a strainer to prevent large particles from entering the pump. The suction interconnector is designed to comply with NEMA standards for motor mounting/dimensions.

Motor

The stator is hermetically encapsulated in stainless steel and the windings are embedded in polymer compound. This results in high mechanical stability, optimum cooling and reduces the risk of short circuits in the windings.

Qty.	Description
1	<p>The shaft seal is of the lip seal type characterised by low friction against the rotor shaft. The NBR elastomer offers good wear resistance, good elasticity and resistance to particles. The rubber material is approved for use in potable water.</p> <p>The motor can be fitted with a Pt100 or Pt1000 sensor that together with a control unit ensures that the maximum operating temperature conditions are not exceeded.</p> <p>Liquid:</p> <p>Pumped liquid: Water</p> <p>Liquid temperature range: -15 .. 40 °C</p> <p>Max liquid t at 0.15 m/sec: 40 °C</p> <p>Selected liquid temperature: 20 °C</p> <p>Density: 998.2 kg/m³</p> <p>Technical:</p> <p>Pump speed on which pump data are based: 2900 rpm</p> <p>Rated flow: 1 m³/h</p> <p>Rated head: 174 m</p> <p>Shaft seal for motor: LIPSEAL</p> <p>Approvals on nameplate: CE, EAC</p> <p>Curve tolerance: ISO9906:2012 3B</p> <p>Motor version: T40</p> <p>Return valve: YES</p> <p>Specification for shaft end: CYLINDRICAL</p> <p>Materials:</p> <p>Pump: Stainless steel EN 1.4301 AISI 304</p> <p>Impeller: Stainless steel EN 1.4301 AISI 304</p> <p>Motor: Stainless steel DIN W.-Nr. 1.4301 AISI 304</p> <p>Installation:</p> <p>Maximum operating pressure: 15 bar</p> <p>Maximum permissible outlet pressure: 28.3 bar</p> <p>Pump outlet: Rp1 1/4</p> <p>Motor diameter: 4 inch</p> <p>Minimum borehole diameter: 105 mm</p> <p>Electrical data:</p> <p>Motor type: MS402</p> <p>Motor type 1-phase: CSCR</p> <p>Motor flange design: GRUNDFOS</p> <p>Rated power - P2: 1.5 kW</p> <p>Power (P2) required by pump: 1.5 kW</p> <p>Mains frequency: 50 Hz</p> <p>Rated voltage: 1 x 240 V</p> <p>Rated current: 9.8 A</p> <p>Starting current: 450 %</p> <p>Cos phi - power factor: 0.98</p> <p>Rated speed: 2860 rpm</p> <p>Start. method: direct-on-line</p> <p>Enclosure class (IEC 34-5): IP68</p> <p>Insulation class (IEC 85): B</p> <p>Built-in temp. transmitter: no</p> <p>Length of cable: 1.7 m</p>



Company name:

Created by:

Phone:

Date:

07/11/2022

Qty.	Description
------	-------------

1	Cable type: FLAT Motor No: 79243106 Windings: Enamelled Others: Minimum efficiency index, MEI \geq : 0.70 ErP status: EuP Standalone/Prod. Net weight: 21.8 kg Gross weight: 34.6 kg Shipping volume: 0.068 m ³
---	--

08102E50 SP 1A-50 50 Hz

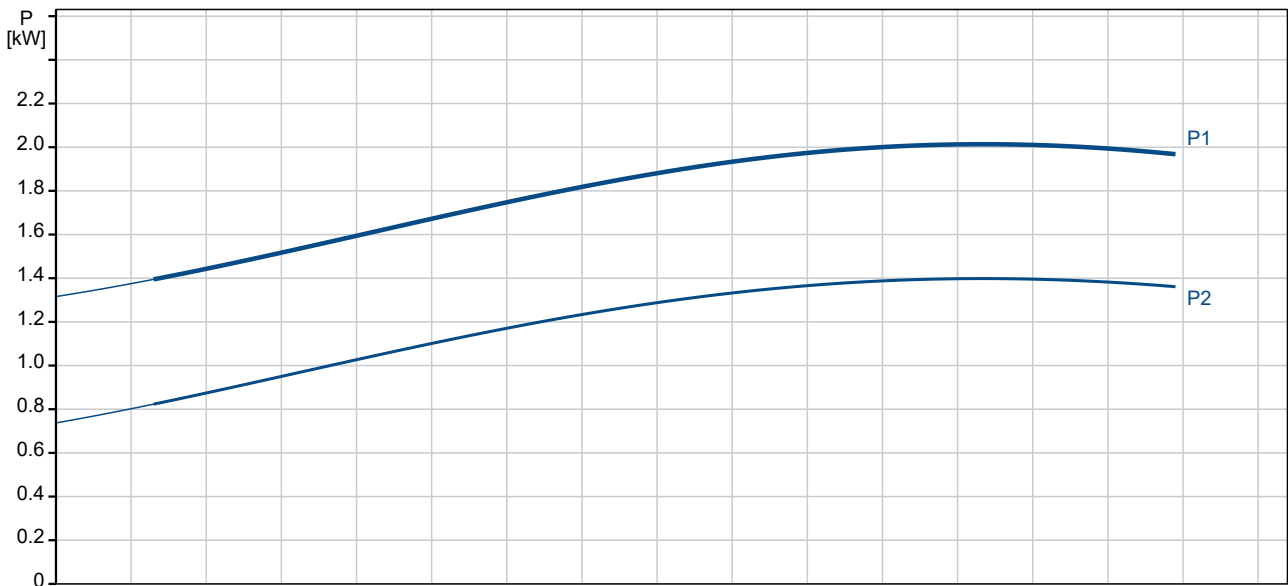
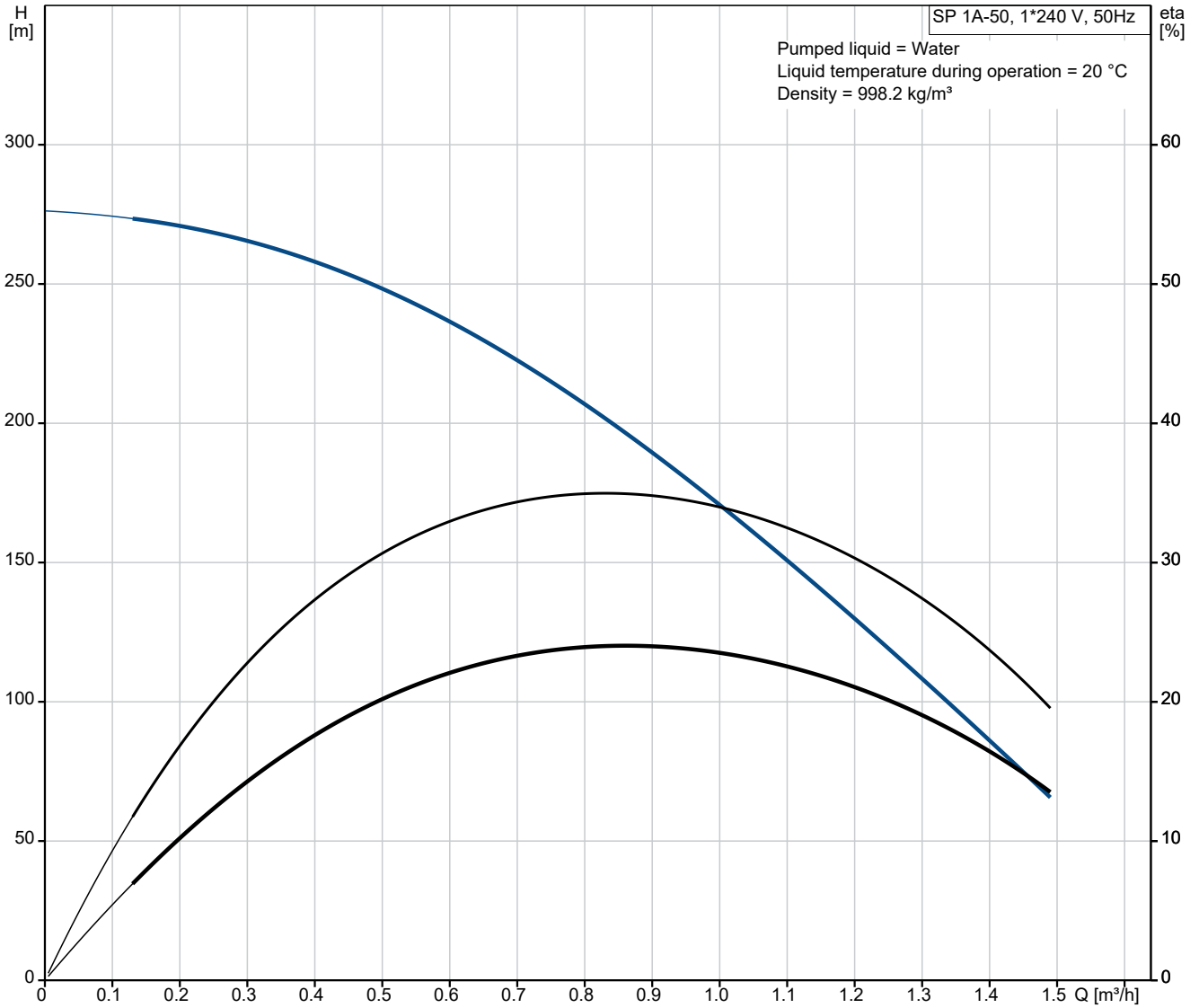

Description	Value
General information:	
Product name:	SP 1A-50
Product No:	08102E50
EAN number:	5700391257032
Technical:	
Pump speed on which pump data are based:	2900 rpm
Rated flow:	1 m ³ /h
Rated head:	174 m
Number of stages:	50
Number of reduced-diameter impellers:	NONE
Shaft seal for motor:	LIPSEAL
Approvals on nameplate:	CE,EAC
Curve tolerance:	ISO9906:2012 3B
The first model is called A which is followed by model B, C etc.:	A
Motor version:	T40
Return valve:	YES
Specification for shaft end:	CYLINDRICAL
Materials:	
Pump:	Stainless steel
Pump:	EN 1.4301
Pump:	AISI 304
Impeller:	Stainless steel
Impeller:	EN 1.4301
Impeller:	AISI 304
Motor:	Stainless steel
Motor:	DIN W.-Nr. 1.4301
Motor:	AISI 304
Installation:	
Maximum operating pressure:	15 bar
Maximum permissible outlet pressure:	28.3 bar
Pump outlet:	Rp1 1/4
Motor diameter:	4 inch
Minimum borehole diameter:	105 mm
Liquid:	
Pumped liquid:	Water
Liquid temperature range:	-15 .. 40 °C
Max liquid t at 0.15 m/sec:	40 °C
Selected liquid temperature:	20 °C
Density:	998.2 kg/m ³
Electrical data:	
Motor type:	MS402
Motor type 1-phase:	CSCR
Motor flange design:	GRUNDFOS
Rated power - P2:	1.5 kW
Power (P2) required by pump:	1.5 kW
Mains frequency:	50 Hz
Rated voltage:	1 x 240 V
Rated current:	9.8 A
Starting current:	450 %
Cos phi - power factor:	0.98
Rated speed:	2860 rpm
Start. method:	direct-on-line
Enclosure class (IEC 34-5):	IP68
Insulation class (IEC 85):	B
Built-in motor protection:	NONE
Thermal protec:	external
Built-in temp. transmitter:	no

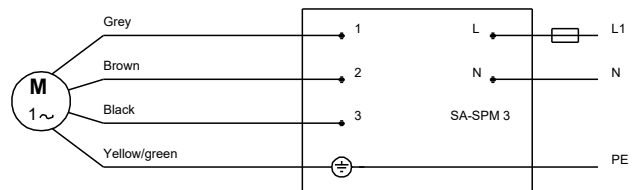
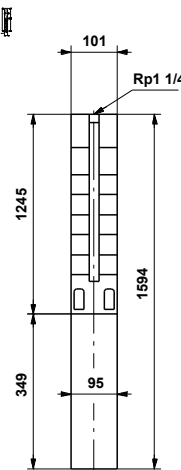
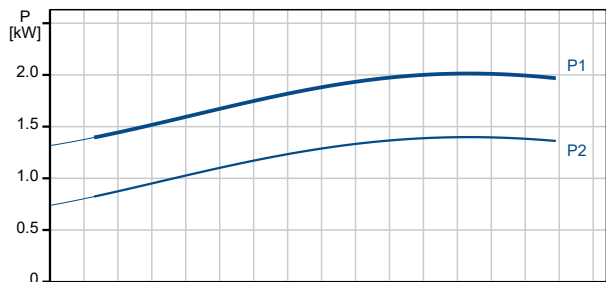
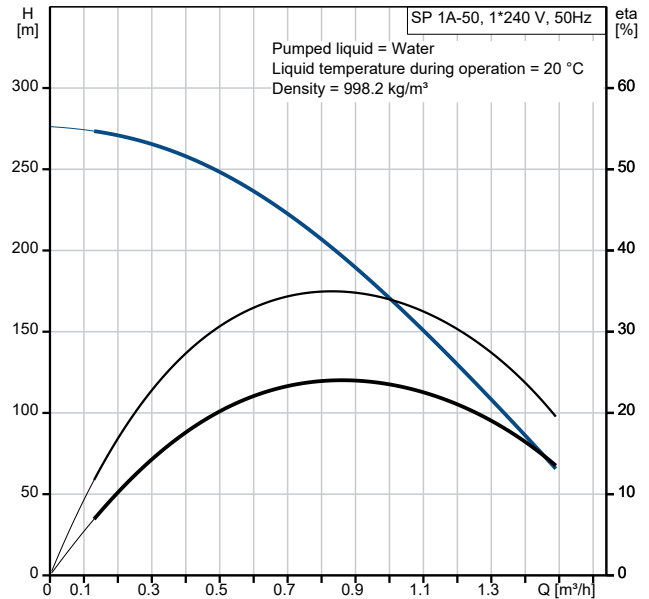



Company name:

Created by:

Phone:

Date:

07/11/2022

Description	Value
Length of cable:	1.7 m
Cable type:	FLAT
Motor No:	79243106
Windings:	Enamelled
Others:	
Minimum efficiency index, MEI ≥:	0.70
ErP status:	EuP Standalone/Prod.
Net weight:	21.8 kg
Gross weight:	34.6 kg
Shipping volume:	0.068 m ³
Sales region:	Australia

08102E50 SP 1A-50 50 Hz

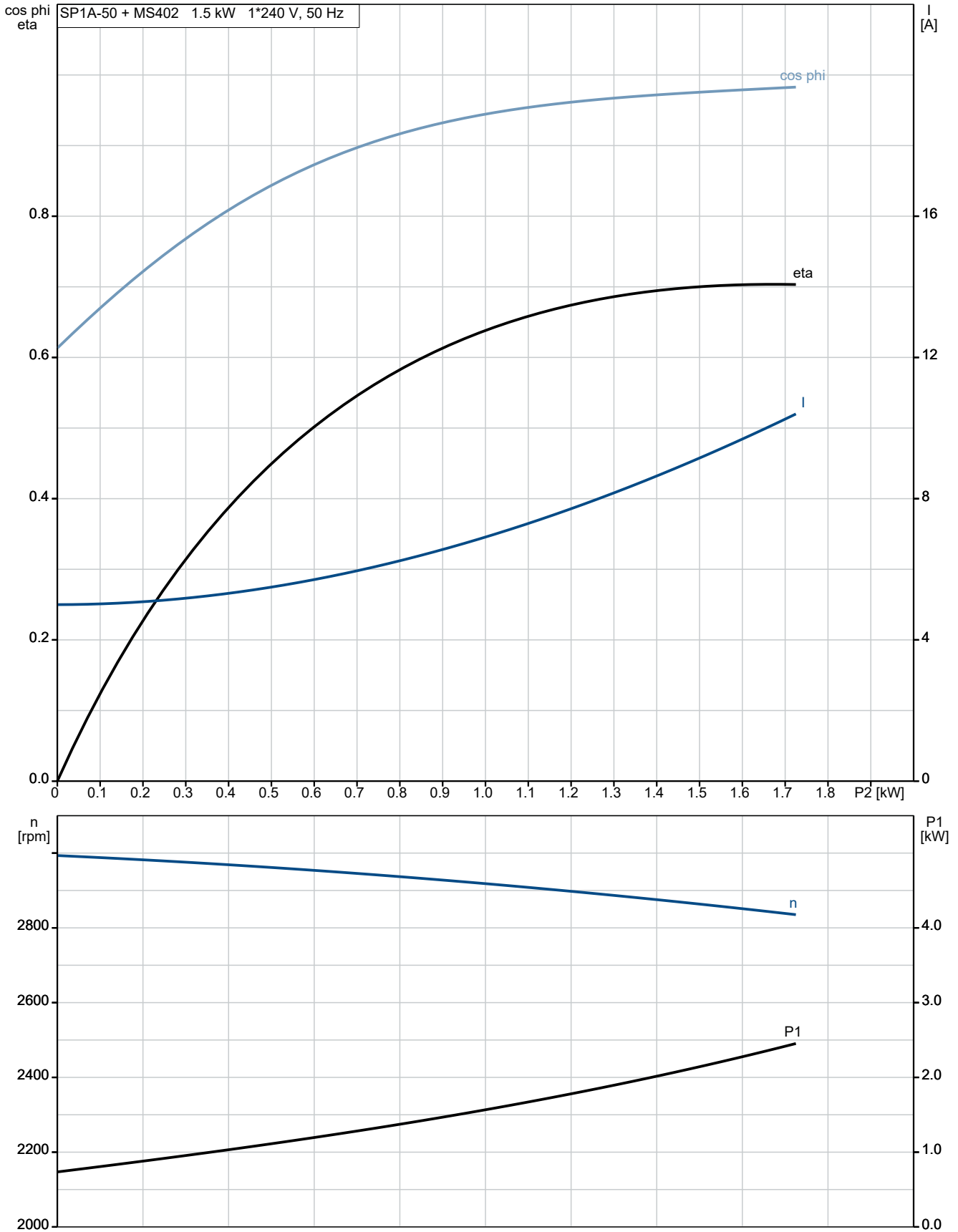

08102E50 SP 1A-50 50 Hz

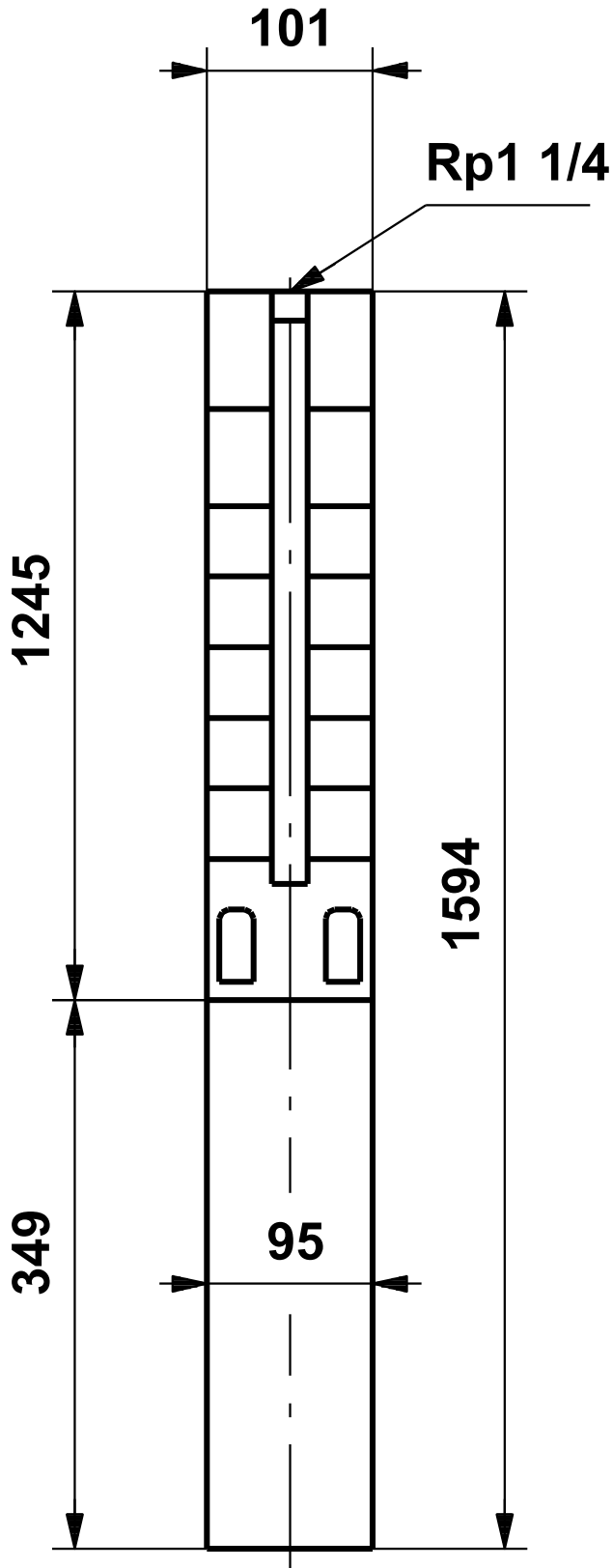

Note! All units are in [mm] unless others are stated.
Disclaimer: This simplified dimensional drawing does not show all details.

08102E50 SP 1A-50 50 Hz

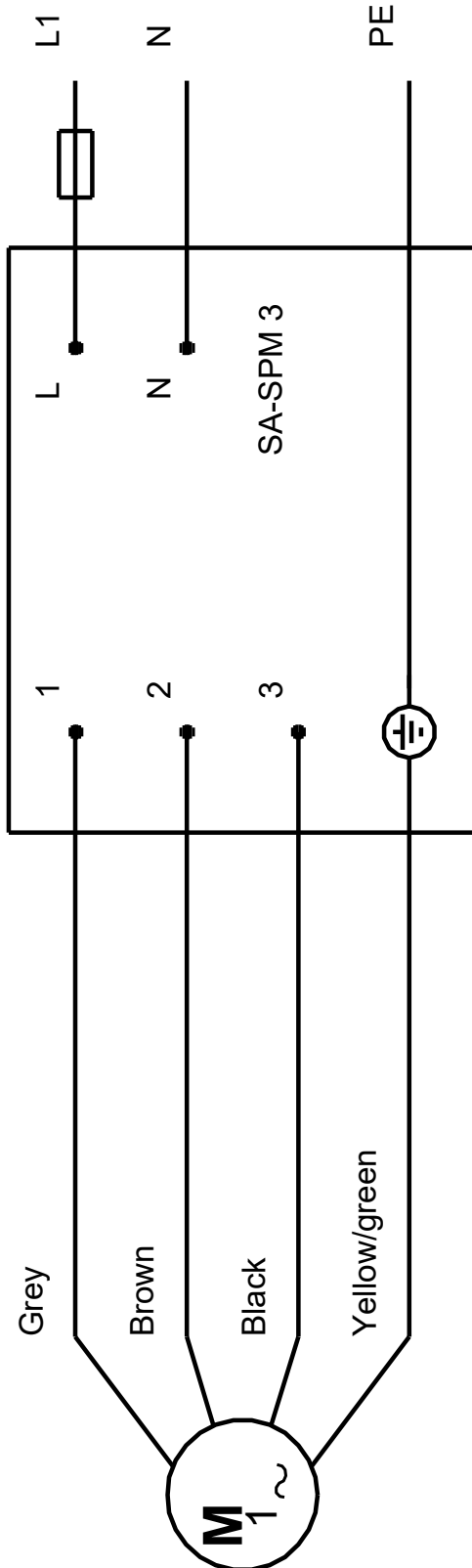

Note! All units are in [mm] unless others are stated.

