

Technical data

Pump name **SWT 150**

Customer	Date 2021-05-13	Company
Contact	Item no.	Issued by
Phone	Project	Phone
E-mail	Project ID	E-mail

Requested data

1	Pump type	CENTRIFUGAL PUMPS FOR POOLS	Fluid	Water
2	Number of pumps / Reserve	1 / 0	Liquid temperature	°C 20
3	Flow m ³ /h		Kin. viscosity	cSt 1.005
4	Head m		Vapour pressure	kPa 2.34
5	Geodetic head m		PH value	
6	Inlet pressure (pin) kPa	0	Density	kg/m ³ 998.3
7	Available system NPSH		Solids	Weight % 0
8	Ambient temperature °C	20		

Pump

9	Pump name	SWT 150	Frequency	Hz 50
10	Design	CENTRIFUGAL PUMPS FOR POOLS	Installation type	STANDARD
11	Manufacturer	EBARA	Impeller Diameter	Max. mm 0
12	Speed rpm	2900		Designed mm
13	No. of Stage	1		Min. mm 0
14	Connection Suction side	Female thread 2" (Kit PV063 included)	Flow	Operating m ³ /h
15	Connection Discharge side	Female thread 2" (Kit PV063 included)		Max- m ³ /h 25
16	Max Working Pressure kPa			Min- m ³ /h 0.96
17	Shut-off head kPa	190.87	Head	Operating m
18	Total weight kg	See the table of "Dimensions".		- (Qmax.) m 4.7
19	Shaft power kW			- (Qmin.) m 19.8
20	Max. fluid temperature °C	40	Max. Shaft Power at max. impeller	kW 1.20
21	Required pump NPSH m		Efficiency	%

Materials

22	Pump body	Polypropylene reinforced with glass fibre	Opening key	Polypropylene reinforced with glass fibre
23	Pump Body Lid	Polypropylene reinforced with glass fibre		
24	Diffuser	Polypropylene reinforced with glass fibre		
25	Impeller	Noryl		
26	Mechanicals seal	Carbon / Ceramic / Stainless Steel AISI 316		
27	Shaft	Stainless Steel AISI 316		

Motor

28	Manufacturer	EPE Standard	Insulation class	F
29	Type	SWT 150_400_Three Phase	Phases	3~
30	Specific design	IE3 / 50 Hz / Pole pairs 1	Frame size	
31	Rated power kW	1.1	Weight	kg
32	Number of poles	2	Electric voltage	V 400
33	Speed rpm	2900	Electric current	A 2.9
34	Degree of protection	IP 55		
35				

Remarks

Performance curve

Pump name **SWT 150**

Customer	Date 2021-05-13	Company
Contact	Item no.	Issued by
Phone	Project	Phone
E-mail	Project ID	E-mail

Requested data

1	Flow	m ³ /h	
2	Head	m	
3	Geodetic head	m	

Pump

Operating Flow	m ³ /h	Impeller Diameter Designed	mm
Operating Head	m	Frequency	Hz 50
		Speed	rpm 2900

Water; 20°C; 998.3kg/m³; 1cSt

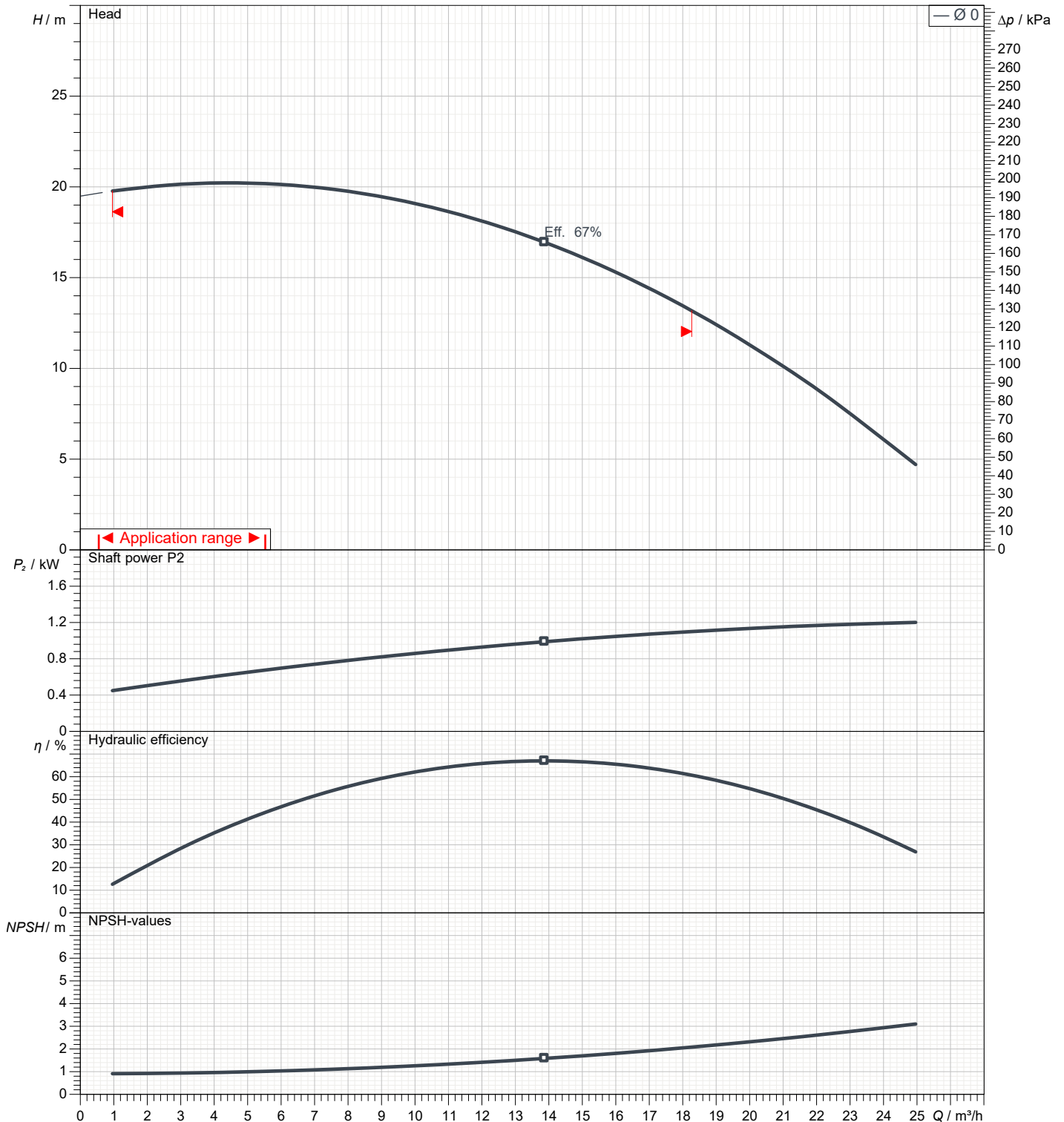

Dimensions

Pump name **SWT 150**

Customer	Date 2021-05-13	Company
Contact	Item no.	Issued by
Phone	Project	Phone
E-mail	Project ID	E-mail

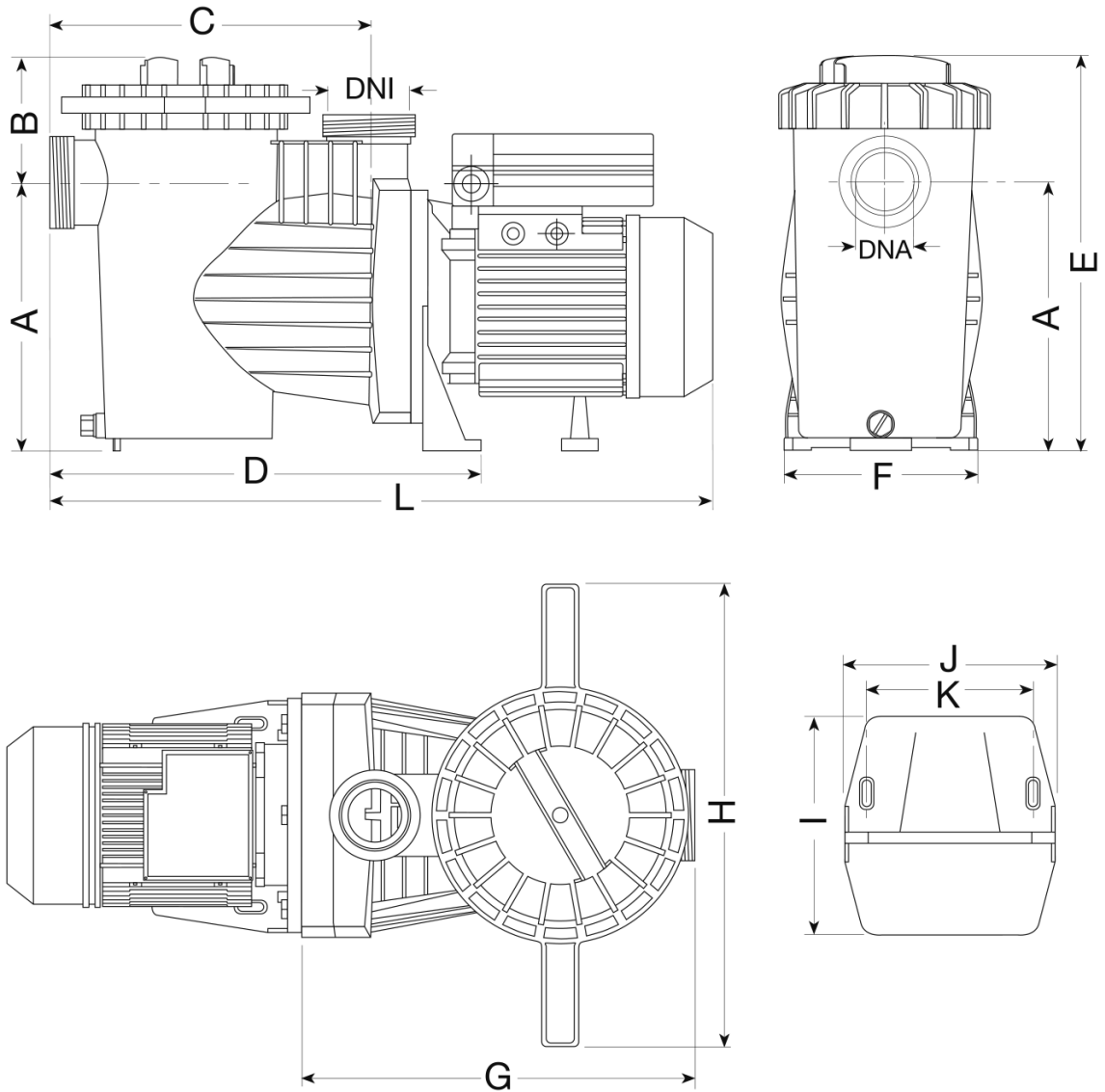

Dimensions in		mm						
1	A	216						
2	B	109						
3	C	265						
4	D	370						
5	DNA	2"						
6	DNI	2"						
7	E	325						
8	F	206						
9	G	325						
10	H	400						
11	I	220						
12	J	205						
13	K	160						
14	L	580						
15	Weight P&M	13,9 kg						

(1/1)

Construction

Pump name SWT 150

Customer	Date 2021-05-13	Company
Contact	Item no.	Issued by
Phone	Project	Phone
E-mail	Project ID	E-mail

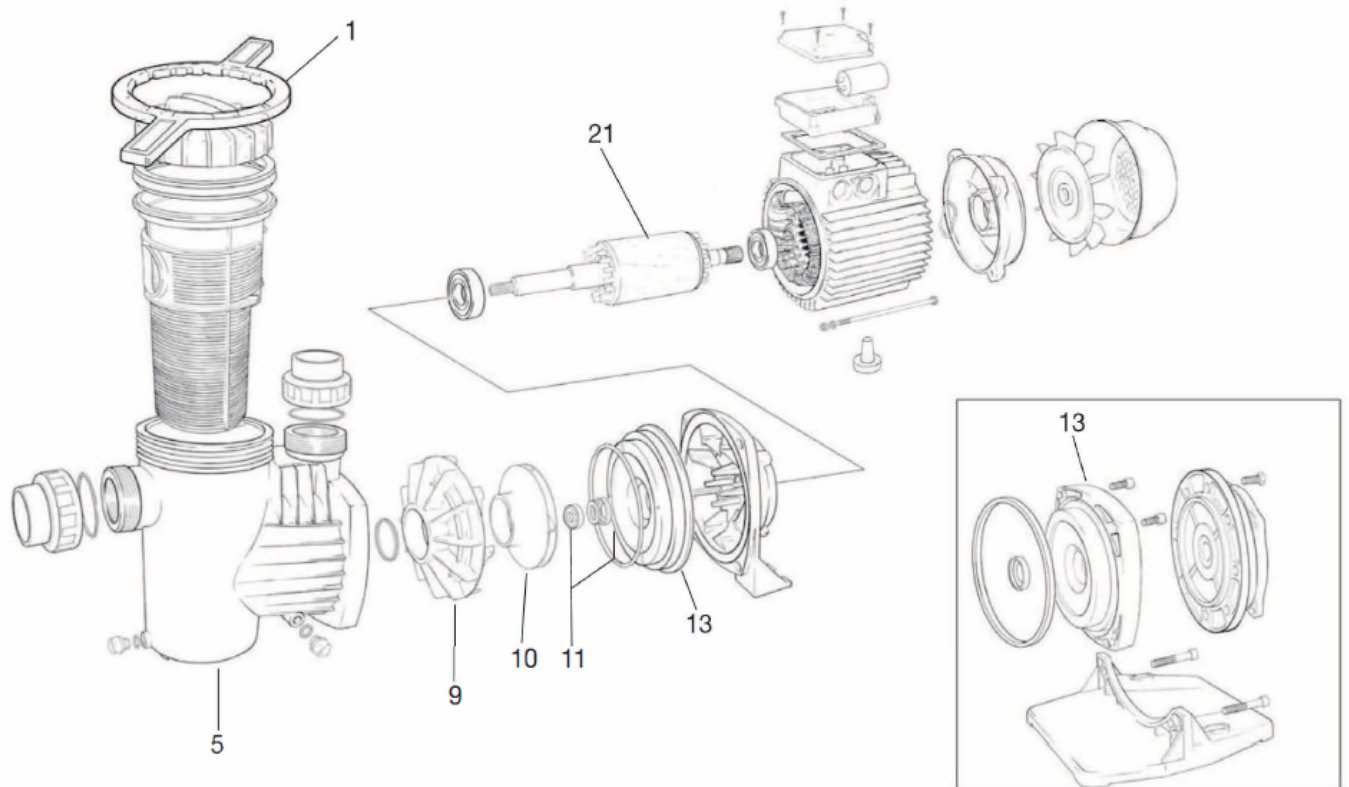

N°	PART NAME	MATERIAL
1	Key	Polypropylene reinforced with glass fibre
5	Pump body	Polypropylene reinforced with glass fibre
9	Diffuser	Polypropylene reinforced with glass fibre
10	Impeller	Noryl
11	Mechanical seal	Carbon / Ceramic / Stainless Steel AISI 316
13	Pump body lid	Polypropylene reinforced with glass fibre
21	Shaft with motor	Stainless Steel AISI 316