

Qty. Description

1 SP 160-3



Note! Product picture may differ from actual product

Product No.: [20024303](#)

Submersible borehole pump, suitable for pumping clean water. Can be installed vertically or horizontally. All steel components are made in stainless steel, EN 1.4301 (AISI 304), that ensures high corrosive resistance. This pump carries drinking water approval.

The pump is fitted with a 37 kW MMS6 motor with sand shield, water-lubricated journal bearings and a volume compensating diaphragm.

The rewindable motor construction allows complete access to the windings for easy rewinding.

The stator windings are PE/PA insulated made for continuous operations (S1).

Suitable for temperatures up to 50 °C.

The motor is fitted with a mechanical shaft seal.

The motor is for direct-on-line starting (DOL).

Further product details

The pump is suitable for applications similar to the following:

- raw-water supply
- irrigation
- groundwater lowering
- pressure boosting
- fountain applications.

Pump

All pump surfaces that are in contact with pumped liquids are made in stainless steel which makes them corrosion- and wear-resistant. The corrosion diagram below shows the capabilities of the pump and motor in relation to the temperature in Celsius (y-axis) and the concentration of chloride in ppm (x-axis).

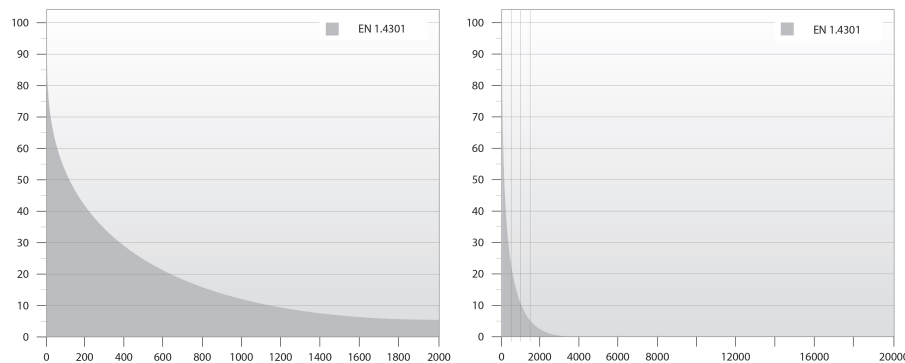

The elastomer parts in the pump are made of NBR (Nitrile-Butadiene Rubber) which ensures good wear resistance and long service intervals.

In case the pump is used for pumping water with high content of hydrocarbons or solvents, Grundfos offers FKM rubber parts (Fluorocarbon) which are oil and temperature-resistant up to 90 °C.

The pump is built with octagonal bearings with sand flush channels that minimise wear. As wear of the pump is inevitable, the pump design allows for easy replacement of all internal wear parts (bearings, impeller, wear rings and seal rings) to maintain high performance and a long lifetime.

The suction interconnector is fitted with a strainer to prevent large particles from entering the pump. The suction interconnector is designed to comply with NEMA standards for motor mounting/dimensions.

Qty. Description

1

Motor

The winding wire is made from pure electrolytic copper insulated by extruded two layers of PE/PA with high dielectric strength properties allowing direct contact between the motor fluid and winding wire.

This ensures the best possible cooling of the winding wire.

The PA layer ensures high mechanical wear properties of the winding wire.

The shaft seal faces are SiC/SiC.

The material combination gives good performance when abrasive particles (sand) is present.

Together with the shaft seal housing, the sand shield forms a labyrinth seal, which during normal operating conditions prevents penetration of sand particles into the shaft seal.

This shaft seal is drinking water approved.

Liquid:

Pumped liquid: Water
 Liquid temperature range: -15 .. 50 °C
 Max liquid t at 0.5 m/sec: 50 °C
 Selected liquid temperature: 20 °C
 Density: 998.2 kg/m³

Technical:

Pump speed on which pump data are based: 2900 rpm
 Rated flow: 160 m³/h
 Rated head: 61 m
 Shaft seal for motor: SIC/SIC
 Approvals on nameplate: CE
 Curve tolerance: ISO9906:2012 3B
 Motor version: T50
 Return valve: YES

Materials:

Pump: Stainless steel
 EN 1.4301
 AISI 304
 Impeller: Stainless steel
 EN 1.4301
 AISI 304
 Motor: Cast iron
 DIN W.-Nr. 0.6025
 ASTM 35-40

Installation:

Maximum operating pressure: 60 bar
 Maximum permissible outlet pressure: 9.7 bar
 Pump outlet: RP6
 Motor diameter: 6 inch
 Minimum borehole diameter: 215 mm

Electrical data:

Motor type: MMS6
 Motor flange design: GRUNDFOS
 Rated power - P2: 37 kW
 Power (P2) required by pump: 37 kW
 Mains frequency: 50 Hz
 Rated voltage: 3 x 380-400-415 V
 Service factor: 1.00
 Rated current: 87.0-84.5-85.0 A
 Starting current: 455-495-510 %
 Cos phi - power factor: 0.85-0.82-0.79
 Rated speed: 2830-2860-2870 rpm
 Start. method: direct-on-line



Company name:

Created by:

Phone:

Date:

07/11/2022

Qty.	Description
------	-------------

1	Enclosure class (IEC 34-5): IP68 Motor No: 96879428 Windings: PE2/PA Others: Minimum efficiency index, MEI ≥: -- ErP status: EuP Standalone/Prod. Net weight: 165 kg Gross weight: 200 kg Shipping volume: 0.295 m ³
---	---

20024303 SP 160-3 50 Hz

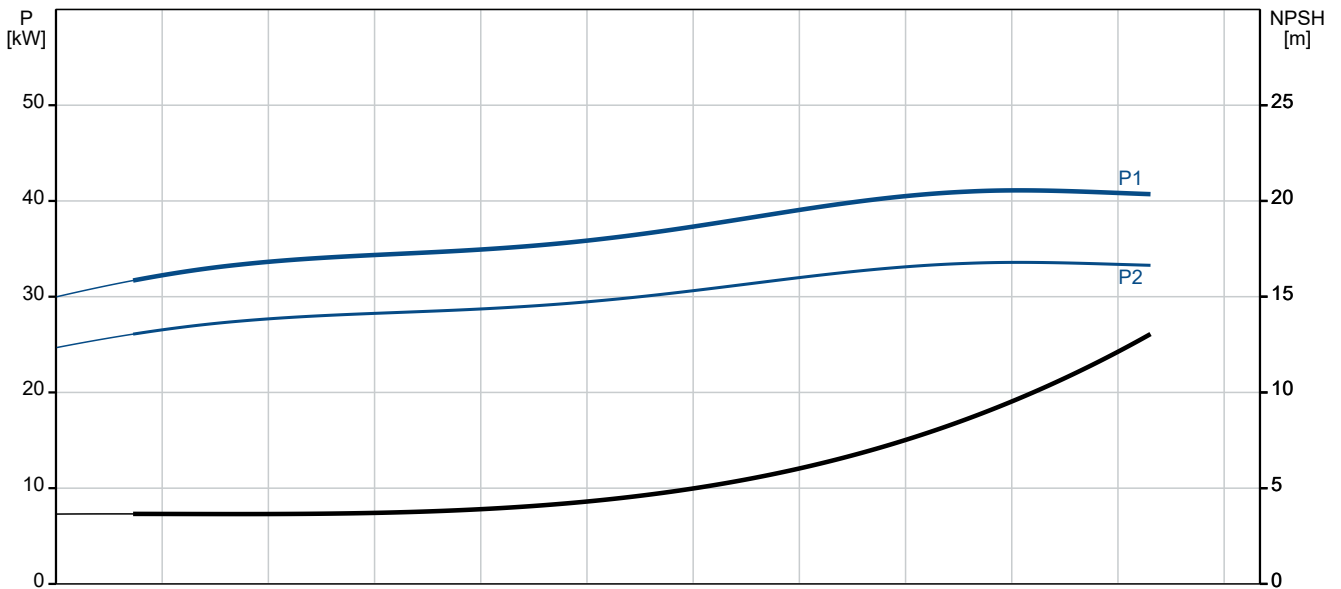
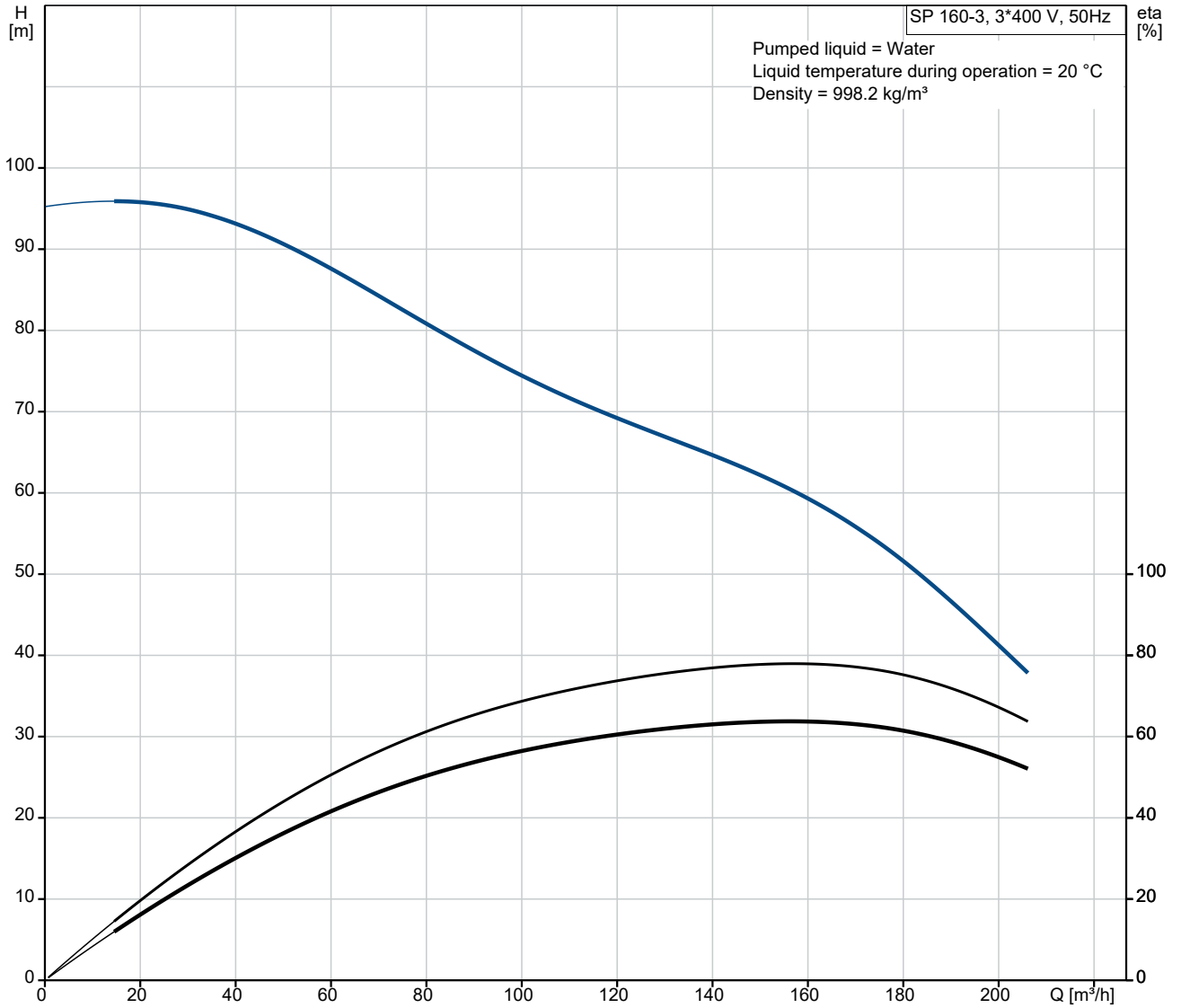

Description	Value
General information:	
Product name:	SP 160-3
Product No:	20024303
EAN number:	5700831507314
Technical:	
Pump speed on which pump data are based:	2900 rpm
Rated flow:	160 m ³ /h
Rated head:	61 m
Number of stages:	3
Number of reduced-diameter impellers:	NONE
Shaft seal for motor:	SIC/SIC
Approvals on nameplate:	CE
Curve tolerance:	ISO9906:2012 3B
The first model is called A which is followed by model B, C etc.:	B
Motor version:	T50
Return valve:	YES
Materials:	
Pump:	Stainless steel
Pump:	EN 1.4301
Pump:	AISI 304
Impeller:	Stainless steel
Impeller:	EN 1.4301
Impeller:	AISI 304
Motor:	Cast iron
Motor:	DIN W.-Nr. 0.6025
Motor:	ASTM 35-40
Installation:	
Maximum operating pressure:	60 bar
Maximum permissible outlet pressure:	9.7 bar
Pump outlet:	RP6
Motor diameter:	6 inch
Minimum borehole diameter:	215 mm
Liquid:	
Pumped liquid:	Water
Liquid temperature range:	-15 .. 50 °C
Max liquid t at 0.5 m/sec:	50 °C
Selected liquid temperature:	20 °C
Density:	998.2 kg/m ³
Electrical data:	
Motor type:	MMS6
Motor flange design:	GRUNDFOS
Rated power - P2:	37 kW
Power (P2) required by pump:	37 kW
Mains frequency:	50 Hz
Rated voltage:	3 x 380-400-415 V
Service factor:	1.00
Rated current:	87.0-84.5-85.0 A
Starting current:	455-495-510 %
Cos phi - power factor:	0.85-0.82-0.79
Rated speed:	2830-2860-2870 rpm
Start. method:	direct-on-line
Enclosure class (IEC 34-5):	IP68
Built-in motor protection:	NONE
Thermal protec:	external
Motor No:	96879428
Windings:	PE2/PA
Others:	

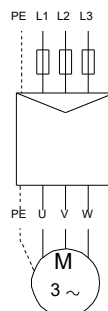
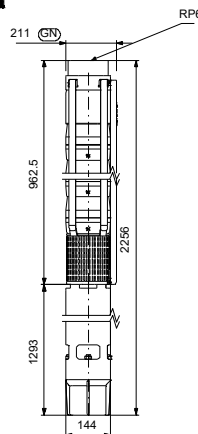
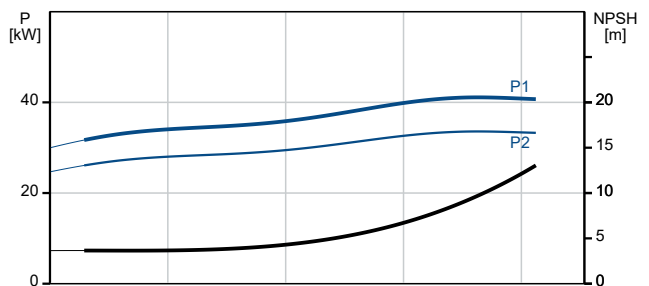
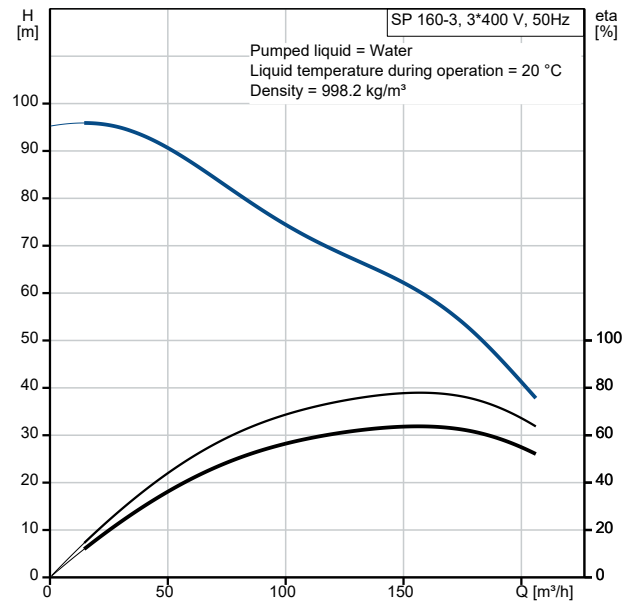



Company name:

Created by:

Phone:

Date: 07/11/2022

Description	Value
Minimum efficiency index, MEI ≥:	--
ErP status:	EuP Standalone/Prod.
Net weight:	165 kg
Gross weight:	200 kg
Shipping volume:	0.295 m ³

20024303 SP 160-3 50 Hz

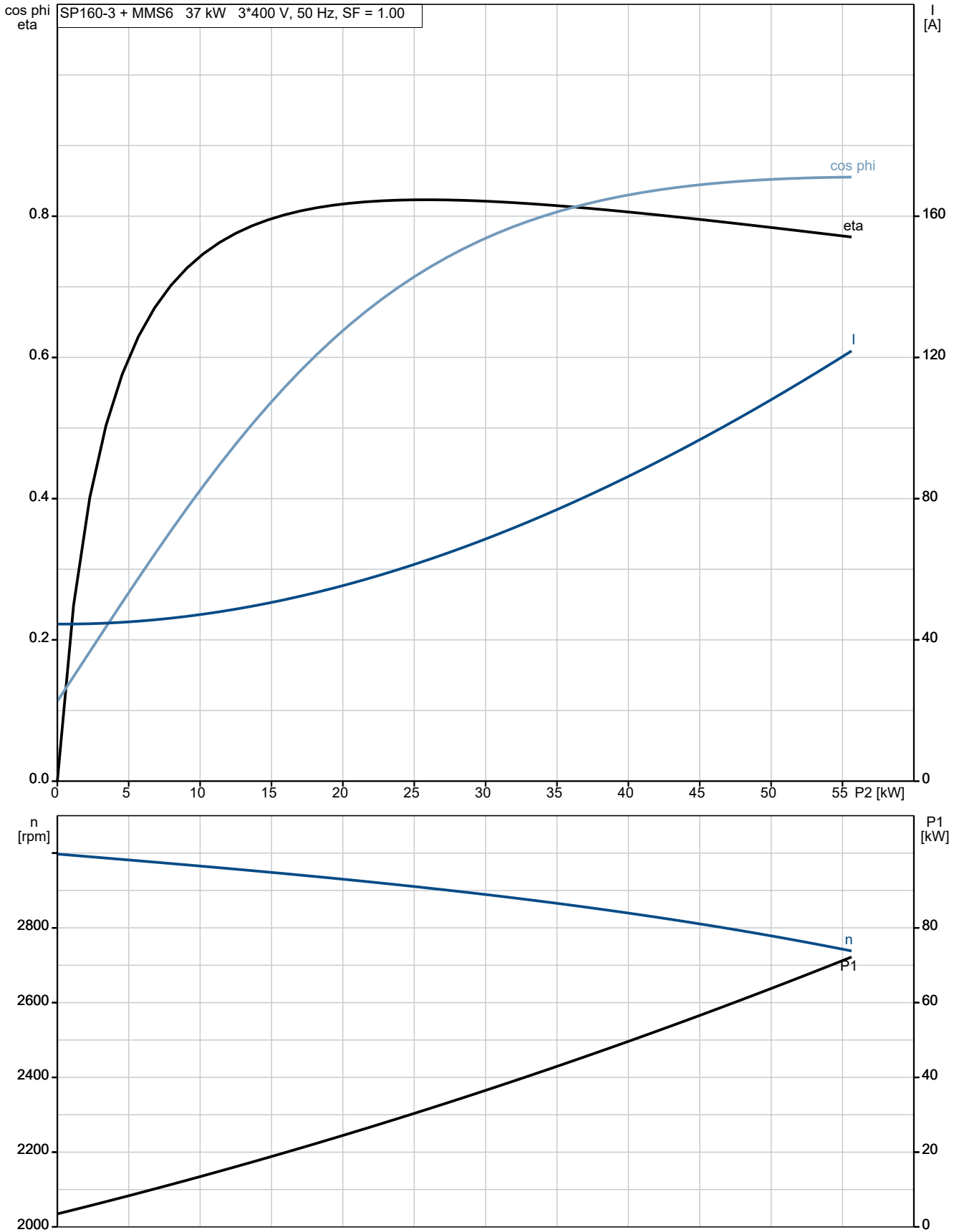

20024303 SP 160-3 50 Hz

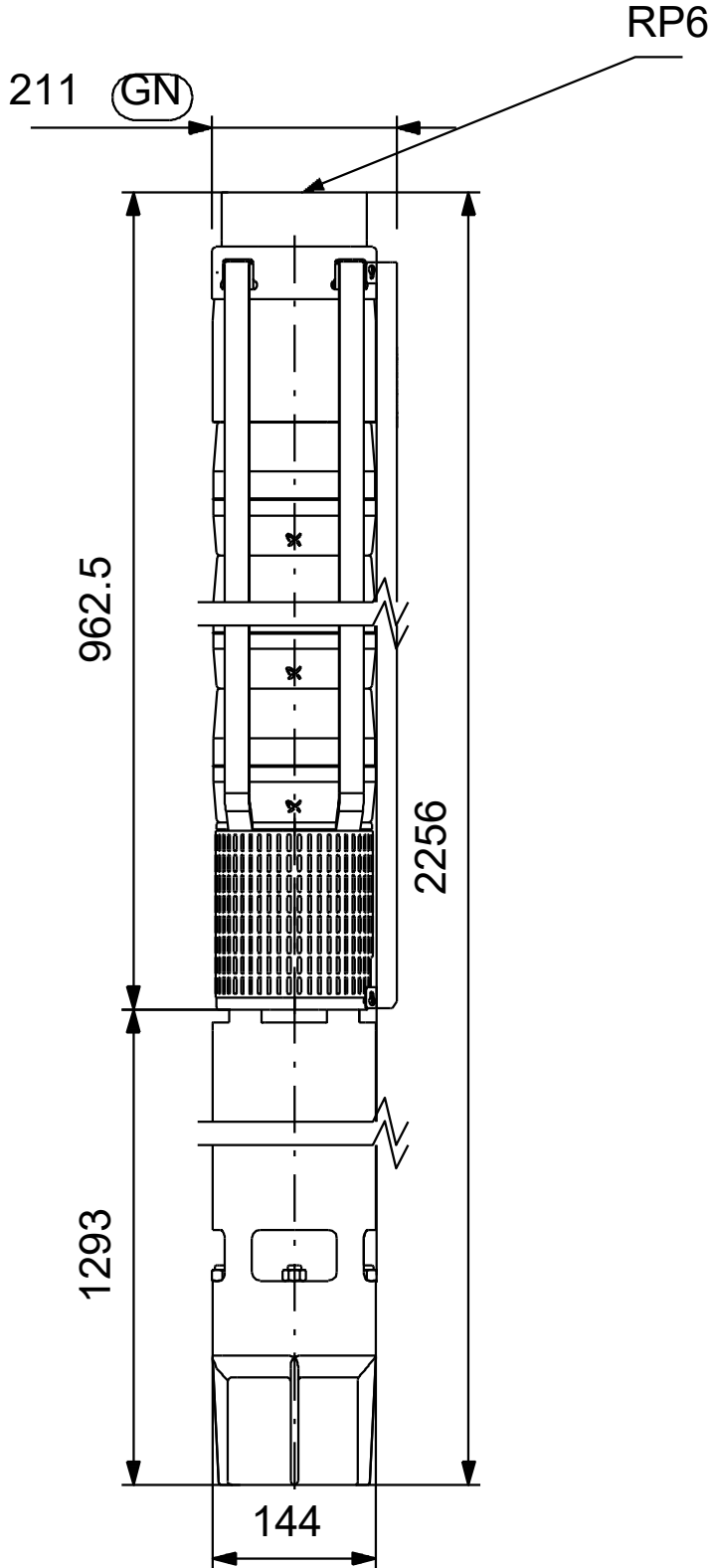

Note! All units are in [mm] unless others are stated.
Disclaimer: This simplified dimensional drawing does not show all details.

20024303 SP 160-3 50 Hz

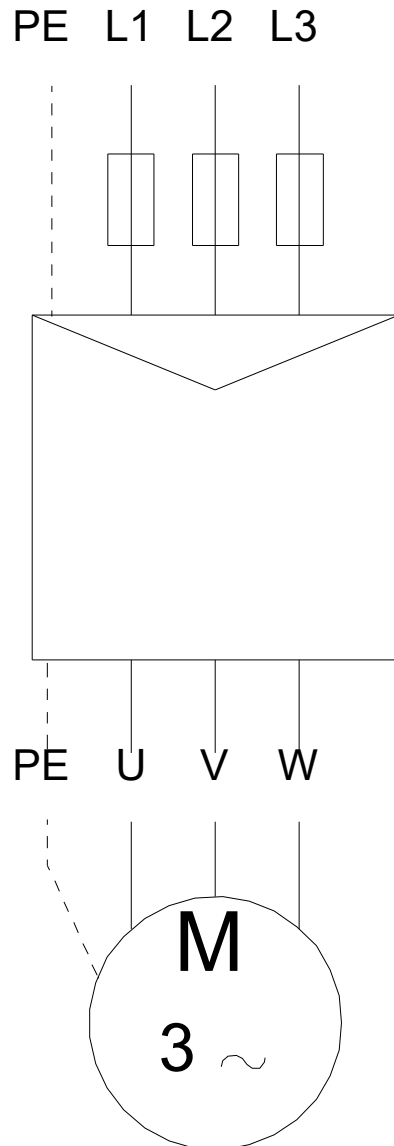

Note! All units are in [mm] unless others are stated.

