

## Data sheet

### Hydraulic data

Minimum efficiency index (MEI)	0,4
Maximum operating pressure $P_N$	10 bar
Min. fluid temperature $T_{min}$	-20 °C
Max. fluid temperature $T_{max}$	120 °C
Min. ambient temperature $T_{min}$	0 °C
Max. ambient temperature $T_{max}$	40 °C

### Motor data

Mains connection	3~380 V, 50/60 Hz
Motor efficiency class	IE4
Rated power $P_2$	3 kW
Rated current $I_N$	9,3 A
Rated speed $n$	2900 1/min
Max. speed $n_{max}$	2900 1/min
Interference emission	EN 61800-3
Interference immunity	EN 61800-3
Insulation class	F
Protection class motor	IP55
Integrated full motor protection	-
Threaded cable connection	1 x M16x1.5

### Materials

Pump housing	Cast iron
Impeller	PPE/PS-GF30
Shaft	Stainless steel
Shaft seal	AQ1EGG
Lantern	Cast iron

### Approved liquids (other liquids upon request)

Heating water (as per VDI 2035)	yes
Heat carrier oil	Special version at additional charge
Cooling and cold water circulation systems	yes
Water-glycol mixtures (at 20 - 40 vol. % glycol and fluid temperature $\leq 40$ °C)	yes

### Installation dimensions

Port-to-port length $L_0$	360 mm
Pipe connection on the suction side $DN_s$	DN 80
Pipe connection on the pressure side $DN_d$	DN 80

Pump curves

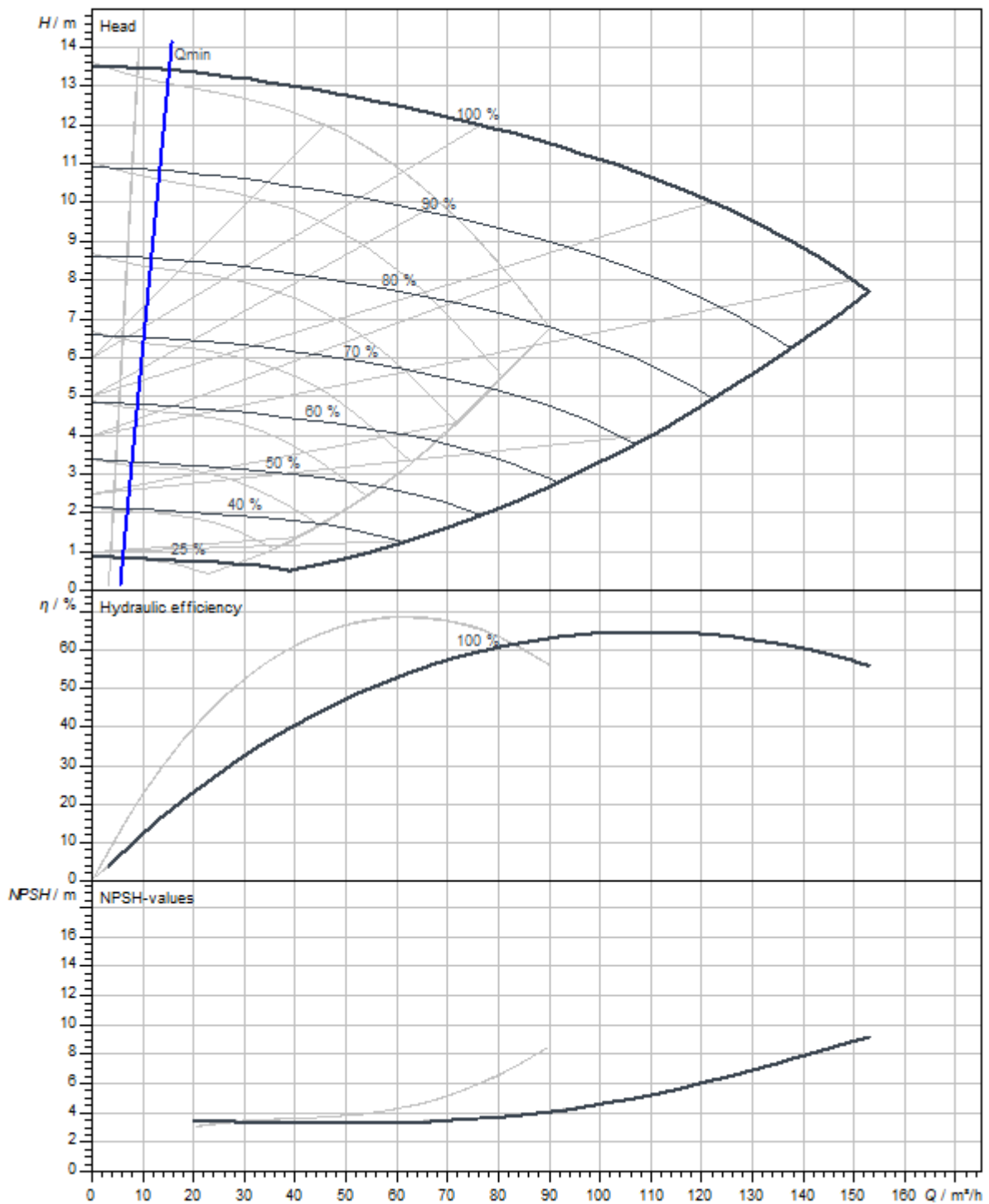

Dimensions and dimensions drawings

VeroTwin-DP-E 80/105-3/2-R1

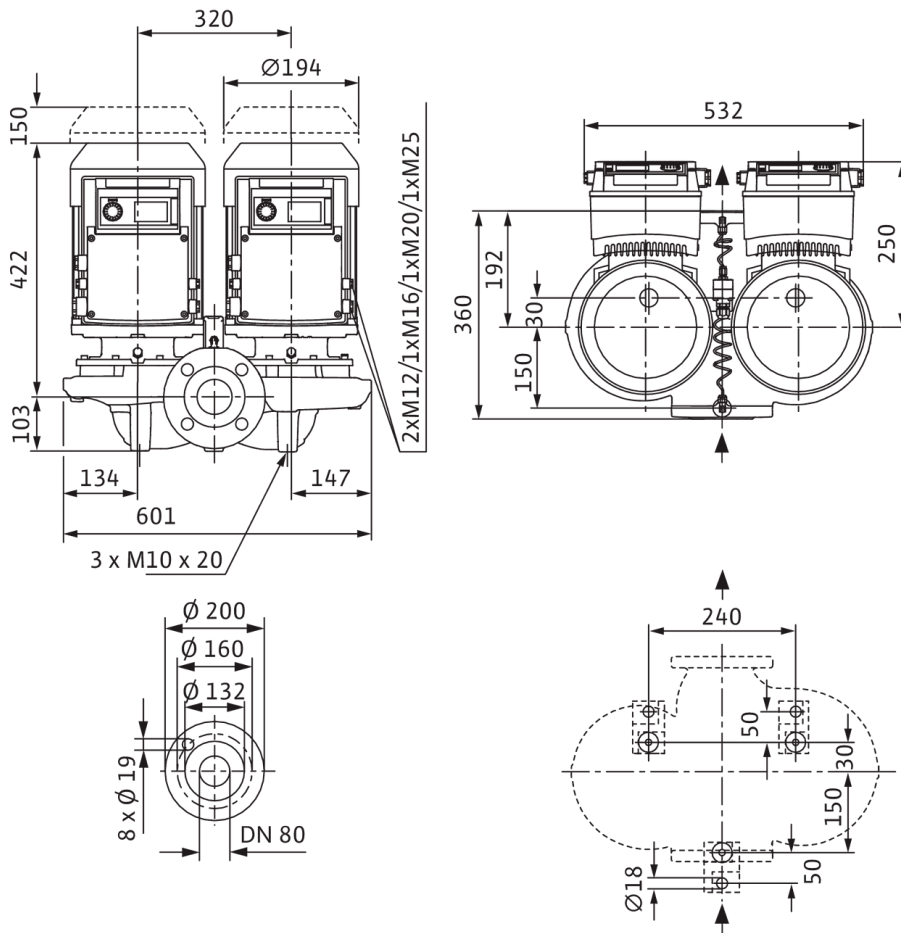

**Note:**

Housing with feet for installation on a base and drilled holes M10, brackets on request.

## Wiring diagram

### IL-E

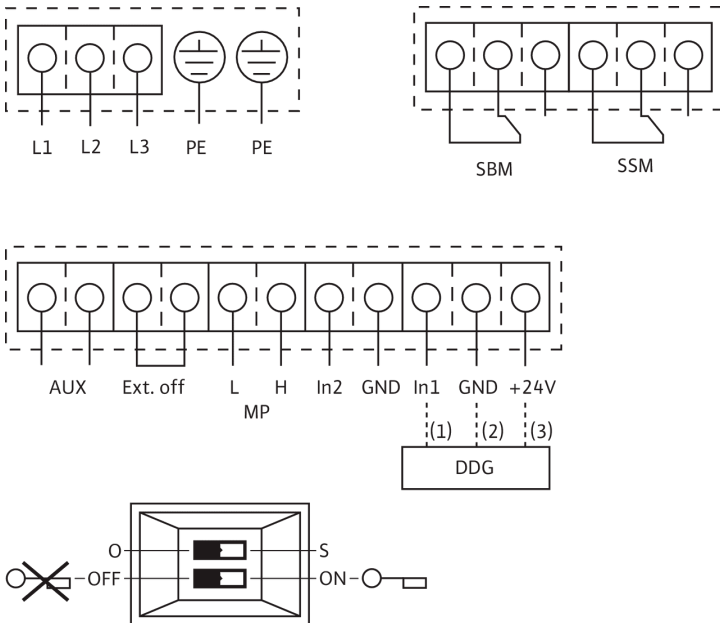

L1, L2, L3: Mains connection: 3~440 V ±10%, 50/60 Hz; 3~400 V ±10%, 50/60 Hz; 3~380 V -5%/+10%, 50/60 Hz

PE: Protective conductor connection

DDG: Connection for differential pressure sensor

In1 (1): Actual value input 0-10 V/0-20 mA; 2-10 V/4-20 mA

GND (2): Ground connection for In1 and In2

+ 24 V (3): DC voltage output for an external consumer/sensor. Max load 60 mA

In2: Setpoint input 0-10 V/0-20 mA; 2-10 V/4-20 mA

MP: Multi-pump, interface for dual pump management

Ext. off: Control input "Overriding Off" The pump can be switched on or off via an external, potential-free contact (24 V DC/10 mA).

SBM:\* Potential-free collective run signal (changeover contact according to VDI 3814)

SSM:\* Potential-free collective fault signal (changeover contact according to VDI 3814)

aux: External pump cycling (only with dual pump operation). Pump cycling can be performed using an external, potential-free contact (24 VDC/10 mA)

DIP switch: 1: Switchover between operation (O) and service mode (S) 2: Activate/deactivate the menu for access disable

Optional: IF-Modules for connection to the building automation

\* Load capacity of contacts for SBM and SSM:

min.: 12 V DC/10 mA

max.: 250 V AC/1 A