

Data sheet

Hydraulic data

Maximum operating pressure P_N	10 bar
Head max H_{max}	8,0 m
Flow max Q_{max}	21,0 m ³ /h
Minimum suction head at 50 °C m	3 m
Minimum suction head at 95 °C m	10 m
Minimum suction head at 110 °C	16 m
Min. fluid temperature T_{min}	-10 °C
Max. fluid temperature T_{max}	110 °C
Min. ambient temperature T_{min}	-10 °C
Max. ambient temperature T_{max}	40 °C

Motor data

Energy efficiency index (EEI)	0,19
Mains connection	1~230 V ±10%, 50/60 Hz
Rated power P_2	229 W
Min. speed n_{min}	750 1/min
Max. speed n_{max}	3750 1/min
Power consumption P_{1min}	7 W
Power consumption P_{1max}	280 W
Interference emission	EN 61800-3;2004+A1;2012 /residential area (C1)
Interference immunity	EN 61800-3;2004+A1;2012 /industrial environment (C2)
Insulation class	F
Protection class	IPX4D

Installation dimensions

Pipe connection on the suction side DN_s	DN 40
Pipe connection on the pressure side DN_d	DN 40
Port-to-port length L_0	220 mm

Materials

Pump housing	Cast iron
Impeller	PPS-GF40
Shaft	1.4122, DLC-coated
Bearing	Carbon, antimony-impregnated

Pump curves

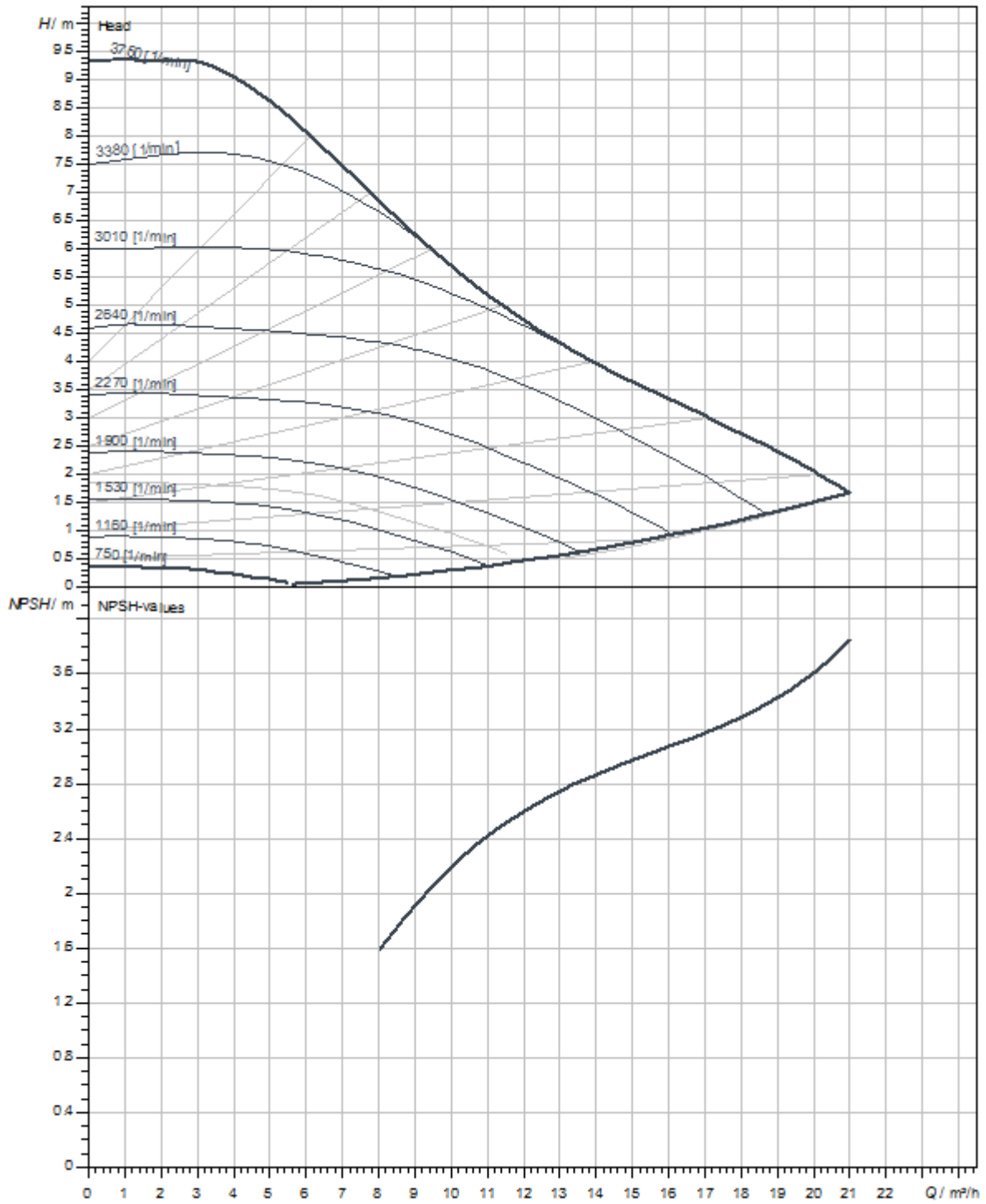

Dimensions and dimensions drawings

Stratos MAXO 40/0,5-8 PN 6/10

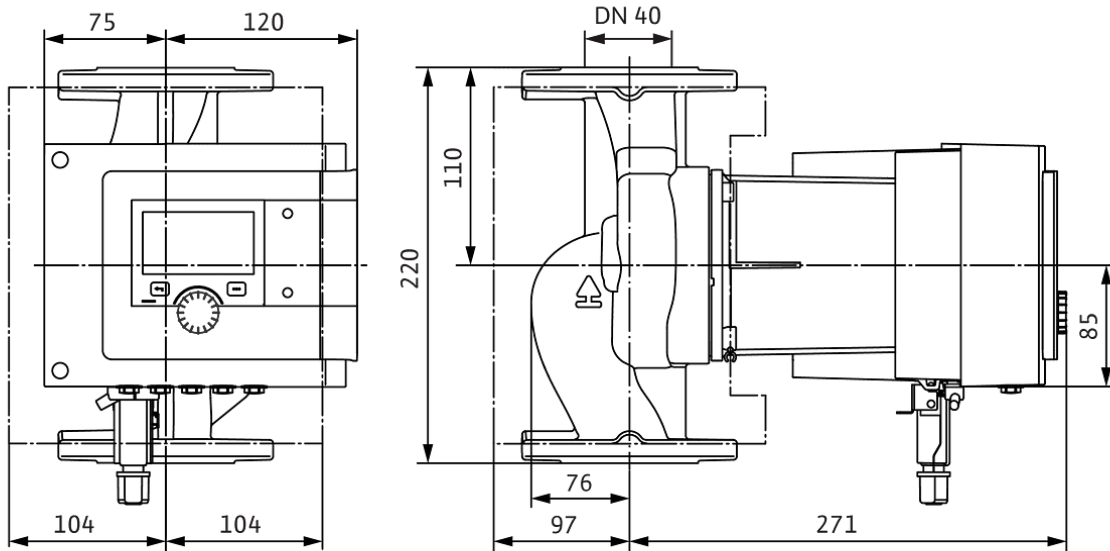

Wiring diagram

Standard: 1~ 230 V, 50/60 Hz, Option: 3~ 230 V, 50/60 Hz

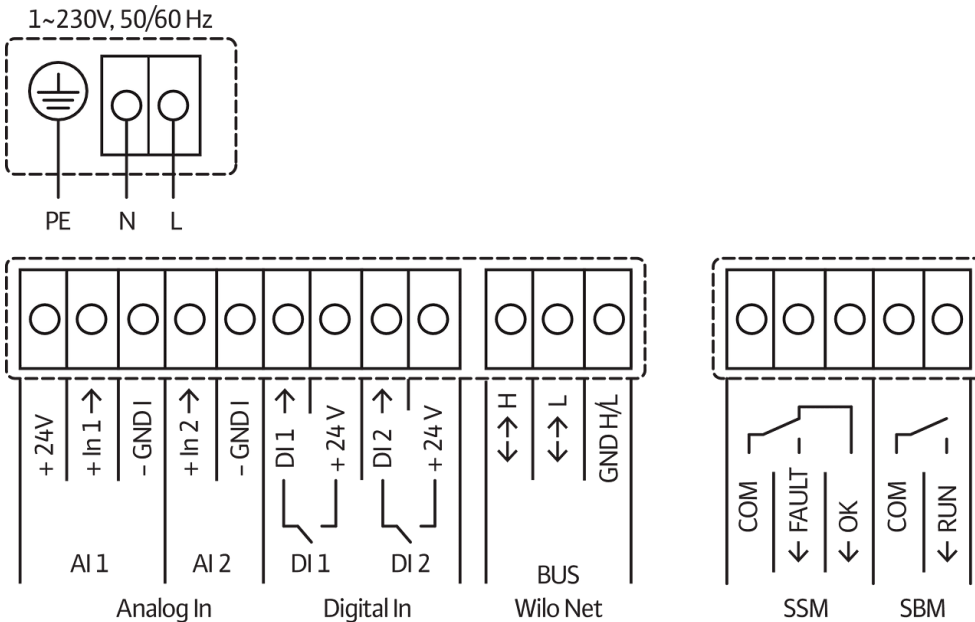

SSM: Collective fault signal (NC contact in accordance with VDI 3814, load capacity 1 A, 250 V ~)