

## Data sheet

### Hydraulic data

Maximum operating pressure $P_N$	10 bar
Head max $H_{max}$	6,0 m
Flow max $Q_{max}$	22,0 m <sup>3</sup> /h
Minimum suction head at 50 °C $m$	3 m
Minimum suction head at 95 °C $m$	10 m
Minimum suction head at 110 °C	16 m
Min. fluid temperature $T_{min}$	-10 °C
Max. fluid temperature $T_{max}$	110 °C
Min. ambient temperature $T_{min}$	-10 °C
Max. ambient temperature $T_{max}$	40 °C

### Motor data

Energy efficiency index (EEI)	0,18
Mains connection	1~230 V ±10%, 50/60 Hz
Rated power $P_2$	216 W
Min. speed $n_{min}$	750 1/min
Max. speed $n_{max}$	3150 1/min
Power consumption $P_{1min}$	7 W
Power consumption $P_{1max}$	270 W
Interference emission	EN 61800-3;2004+A1;2012 /residential area (C1)
Interference immunity	EN 61800-3;2004+A1;2012 /industrial environment (C2)
Insulation class	F
Protection class	IPX4D

### Installation dimensions

Pipe connection on the suction side $DN_s$	DN 50
Pipe connection on the pressure side $DN_d$	DN 50
Port-to-port length $L_0$	240 mm

### Materials

Pump housing	Cast iron
Impeller	PPS-GF40
Shaft	1.4122, DLC-coated
Bearing	Carbon, antimony-impregnated

Pump curves

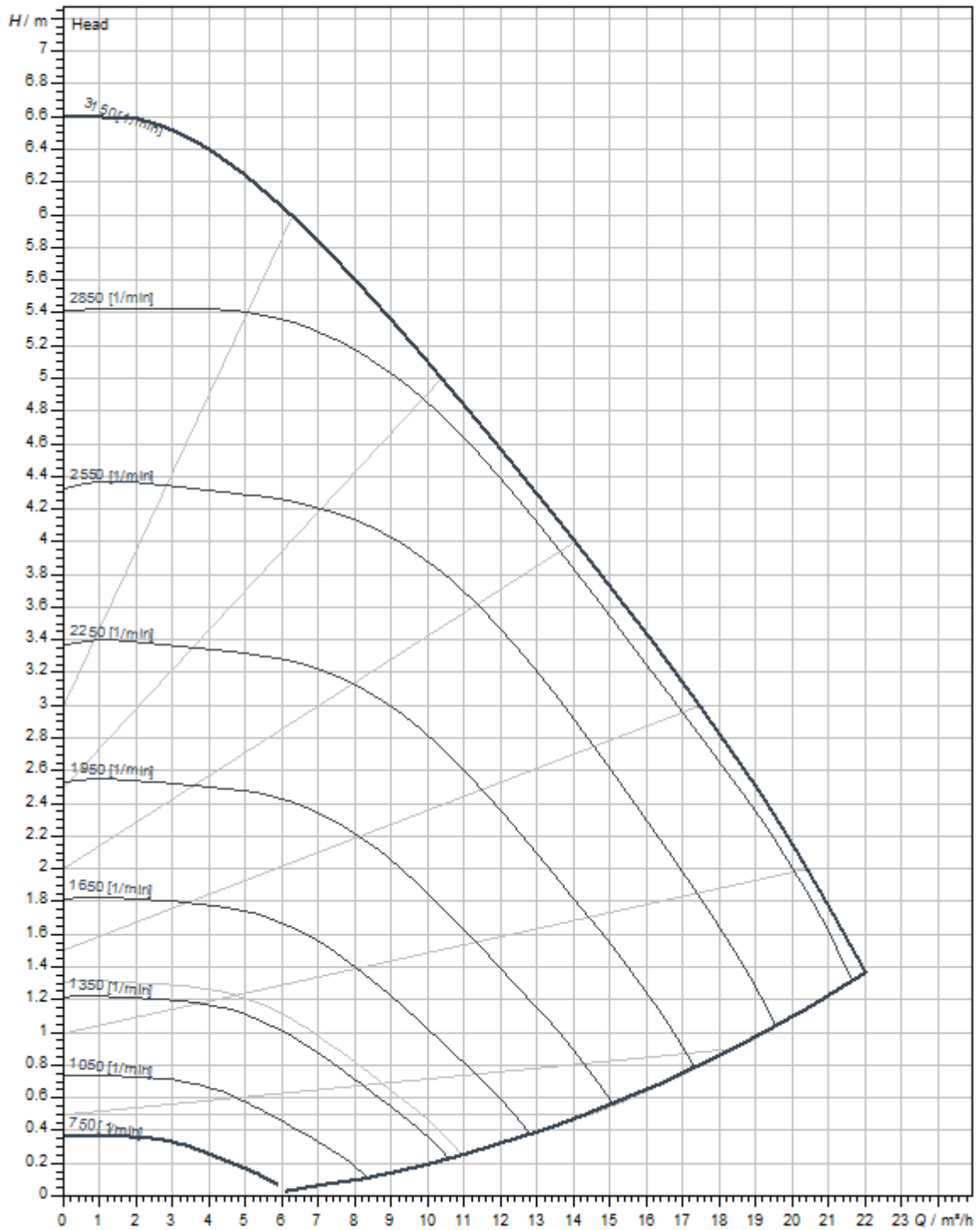

Dimensions and dimensions drawings

Stratos MAXO 50/0,5-6 PN 6/10

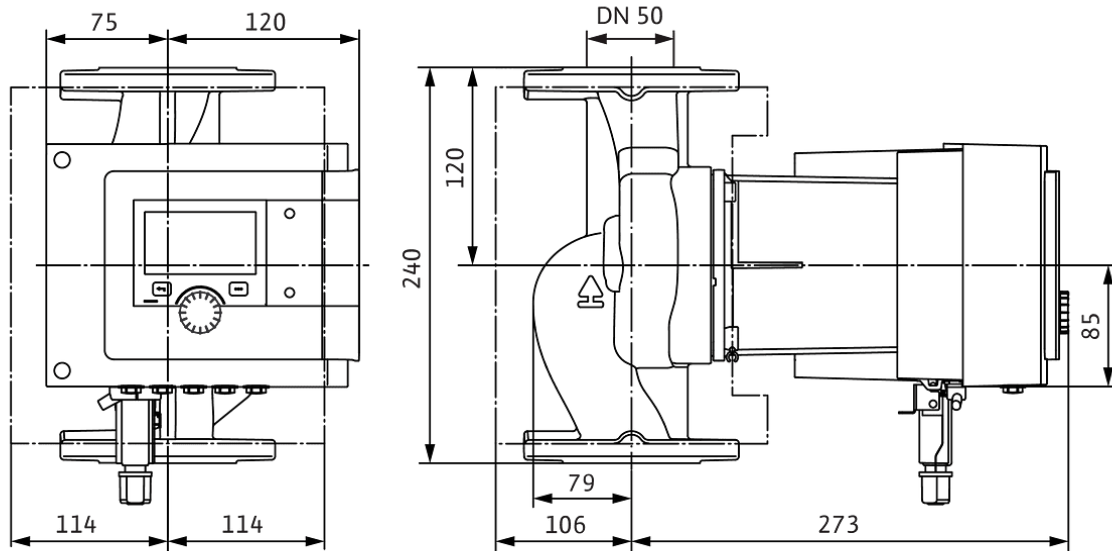

Wiring diagram

Standard: 1~ 230 V, 50/60 Hz, Option: 3~ 230 V, 50/60 Hz

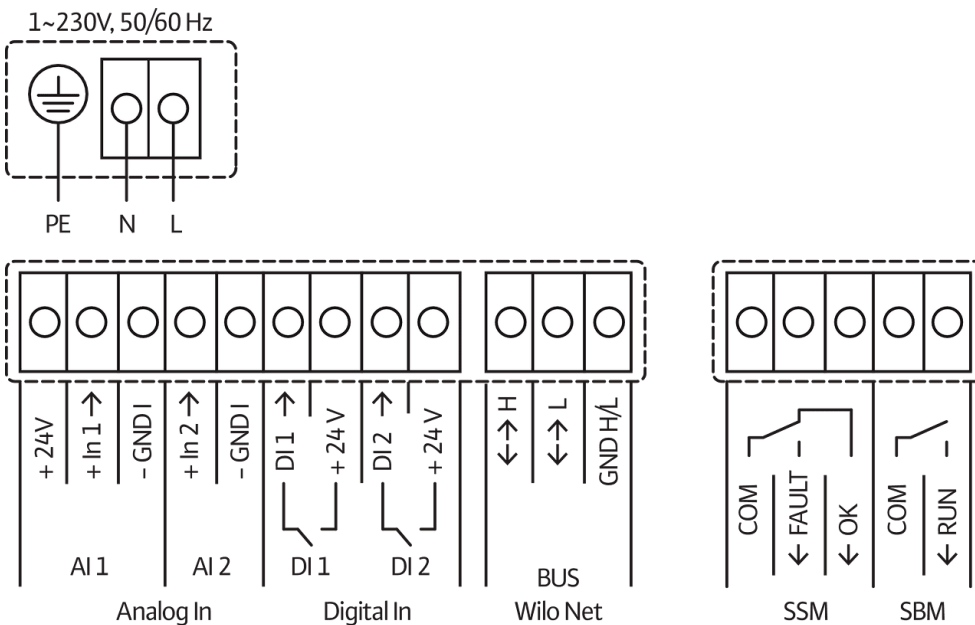

SSM: Collective fault signal (NC contact in accordance with VDI 3814, load capacity 1 A, 250 V ~)