

Data sheet

Operating data

Fluid media	Water
-------------	-------

Hydraulic data

Maximum operating pressure P_N	10 bar
Head max H_{max}	16.0 m
Flow max Q_{max}	30.0 m ³ /h
Minimum suction head at 50 °C m	5 m
Minimum suction head at 95 °C m	12 m
Minimum suction head at 110 °C	18 m
Min. fluid temperature T_{min}	-10 °C
Max. fluid temperature T_{max}	90 °C
Min. ambient temperature T_{min}	-10 °C
Max. ambient temperature T_{max}	40 °C

Motor data

Energy efficiency index (EEI)	0.17
Mains connection	1~230 V ±10%, 50/60 Hz
Min current I_{min}	0.2 A
Max current I_{max}	2.8 A
Rated power P_2	537 W
Min. speed n_{min}	650 1/min
Max. speed n_{max}	3850 1/min
Power consumption $P_{1 min}$	10 W
Power consumption $P_{1 max}$	640 W
Interference emission	EN 61800-3;2004+A1;2012 /residential area (C1)
Interference immunity	EN 61800-3;2004+A1;2012 /industrial environment (C2)
Insulation class	F
Protection class	IPX4D

Installation dimensions

Pipe connection on the suction side DNs	DN 40
Pipe connection on the discharge side DNd	DN 40
Port-to-port length LO	250 mm

Materials

Pump housing	Cast iron
Impeller	PPS-GF40
Shaft	1.4028, DLC-coated
Bearing	Carbon, antimony-impregnated

Pump curves

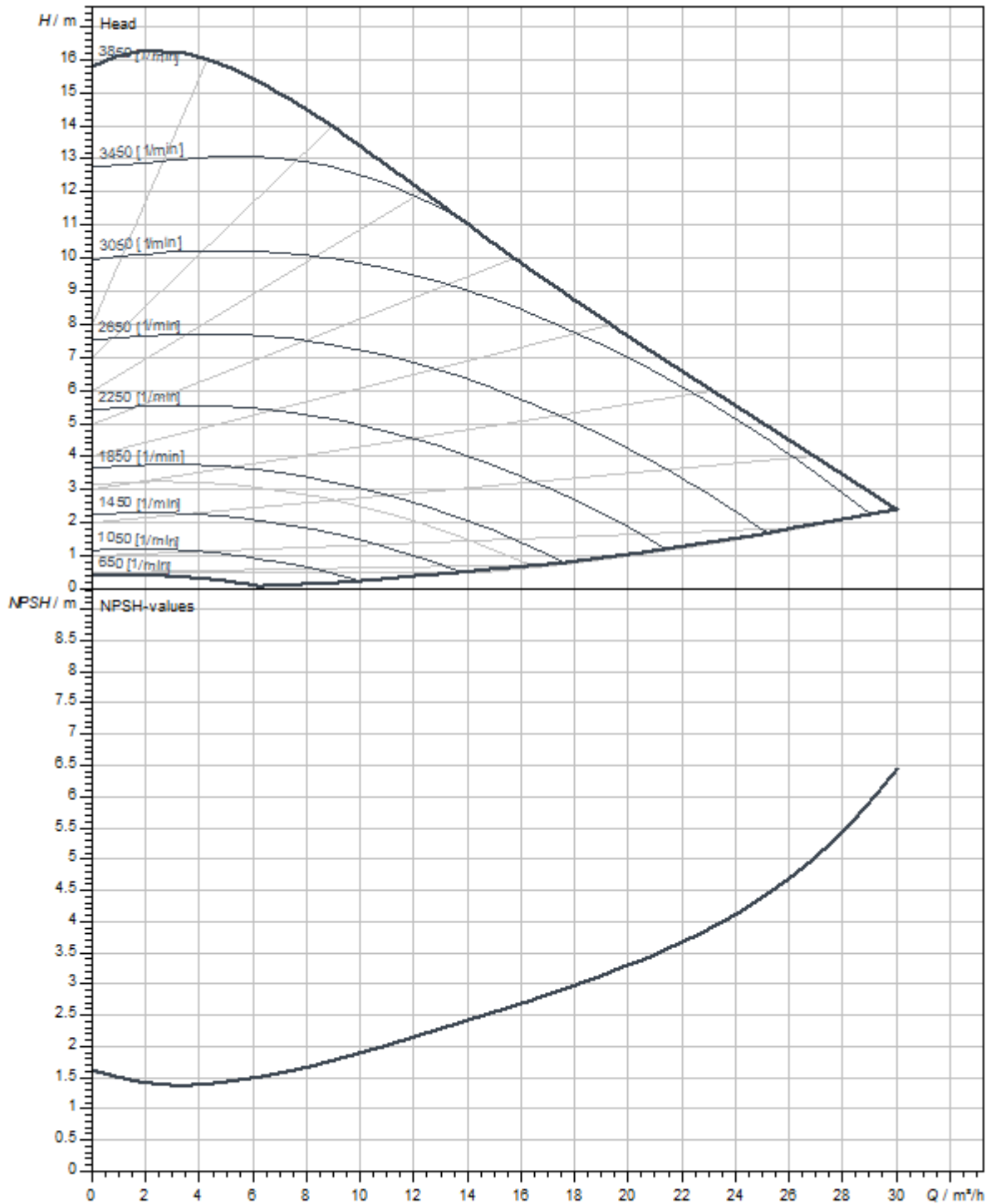

Dimensions and dimensions drawings

Stratos MAXO 40/0,5-16 PN6/10-R7

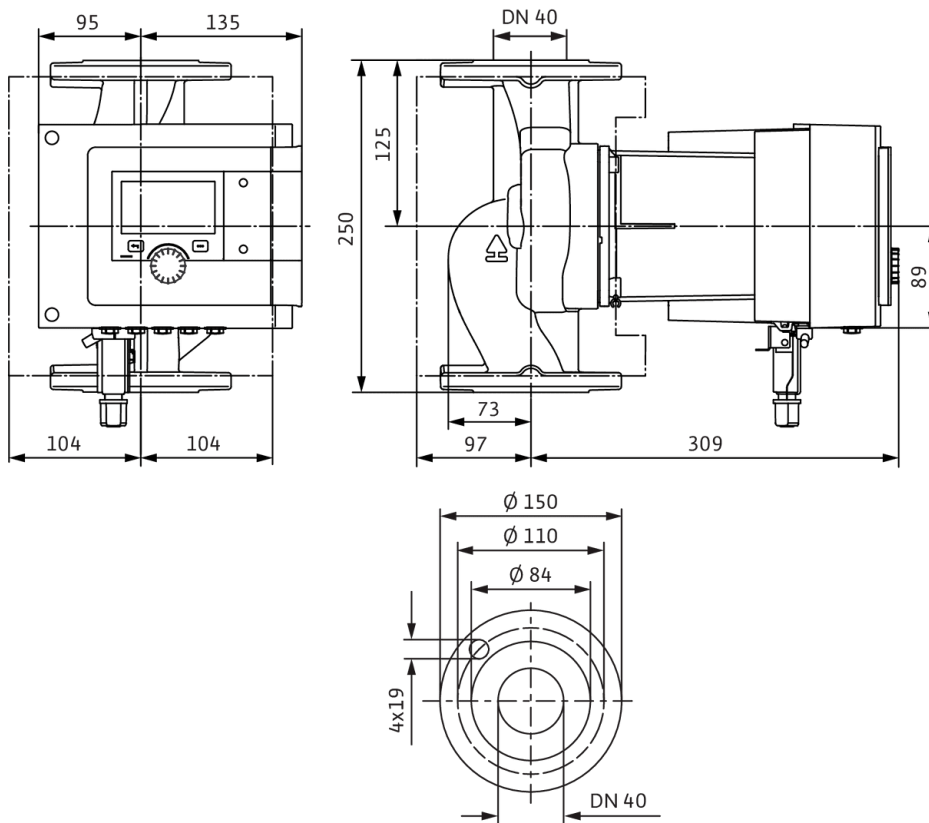

Wiring diagram

Standard: 1~ 230 V, 50/60 Hz, Option: 3~ 230 V, 50/60 Hz

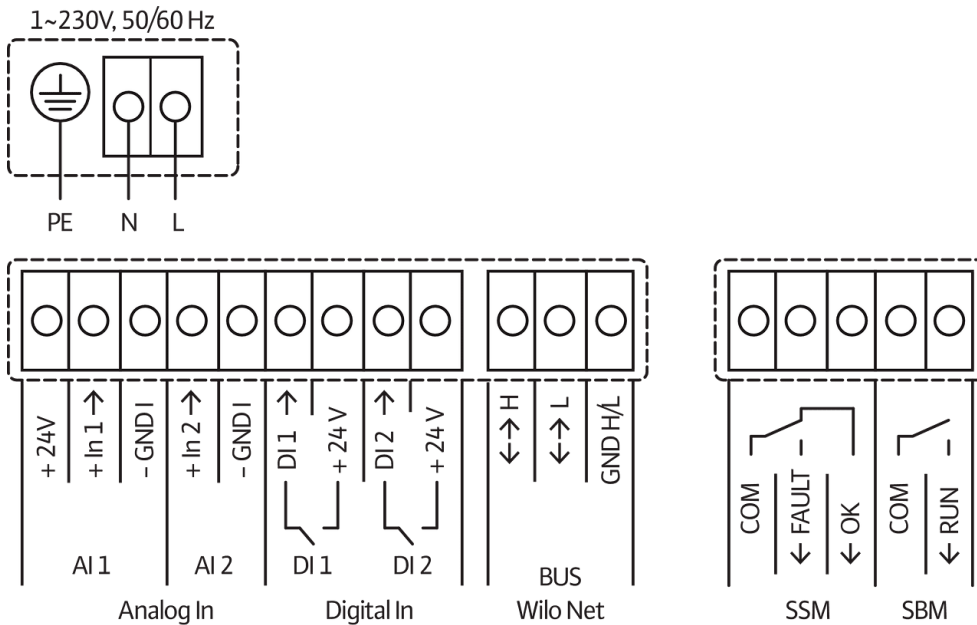

SSM: Collective fault signal (NC contact in accordance with VDI 3814, load capacity 1 A, 250 V ~)

Ordering information

Product data

Brand	Wilo
Product description	Stratos MAXO 40/0,5-16 PN6/10-R7
Article number	2217952
EAN number	4062679195315
Colour	Green/black/silver
Minimum order quantity	1
Date of sales availability	2021-09-01

Dimension, weight

Length with packaging	600 mm
Length <i>L</i>	410 mm
Height with packaging	394 mm
Height <i>H</i>	250 mm
Width with packaging	400 mm
Width <i>W</i>	239 mm
Gross weight, approx. <i>m</i>	19.9 kg
Net weight, approx. <i>m</i>	16 kg

Packaging

Number per layer	4
Packaging property	Transport packaging
Packaging type	Cardboard box
Pieces per pallet	8

Tender text

Premium smart-pump Wilo-Stratos MAXO-R7

High efficiency in-line glandless pump with EC motor and electronic power adjustment. Can be used for cold water, heating water and water/glycol mixtures. Energy efficiency index (EEI) between ≤ 0.17 and ≤ 0.19 depending on pump type.

Control modes:

- > Permanent, automatic power adjustment to system requirements without setpoint specification **Wilo Dynamic Adapt plus** (factory setting). Up to 20% energy savings compared to dp-v control mode.
- > Constant temperature (**T-const.**)
- > Constant differential temperature (**dT-const.**)
- > Needs-based volume flow optimisation of the feeder pump through connectivity and communication between multiple pumps (**Multi-Flow Adaptation**).
- > Constant volume flow (**Q-const.**)
- > Differential pressure control (dp-c) to a remote point in the pipe network (**index circuit evaluator**)
- > Constant differential pressure (**dp-c**)
- > Variable differential pressure (**dp-v**) with the option to set the nominal duty point
- > Constant speed (**n-const.**)
- > User-defined **PID** control

Functions:

- > Heat quantity measurement
- > Cooling quantity measurement
- > Pump automatically deactivates when no flow is detected (**No-Flow Stop**)
- > Switchover between heating and cooling mode (automatic, external or manual) (automatic, possible with Stratos MAXO temperature sensor)
- > Adjustable volume flow limiter using the Q-Limit function (**Q_{min.}** and **Q_{max.}**)
- > Operating modes of twin-head pumps: Efficiency-optimised **parallel operation** for dp-c and dp-v, main and standby operation
- > Ability to save and restore configured pump settings (**3 restoration points**)
- > **Fault and warning messages** shown in plain text with advice on resolving the issue
- > **Pump venting function** for automatic venting of the rotor chamber
- > Automatic **setback operation** (possible with Stratos MAXO temperature sensor)
- > Automatic **deblocking function** and integrated **full motor protection**
- > **Dry-running detection**

Display:

- > Control mode
- > Setpoint
- > Volume flow
- > Temperature (possible with Stratos MAXO temperature sensor)
- > Power consumption
- > Electric consumption
- > Active influences (e.g. STOP, No-Flow Stop)

Version:

- > **2 configurable analogue inputs:** 0–10 V, 2–10 V, 0–20 mA, 4–20 mA and commercially available PT1000; +24 V DC power supply
- > **2 configurable digital inputs** (Ext. OFF, Ext. Min, Ext. Max, heating/cooling, manual override (uncoupled from building automation), operation lock (key lock and remote operation configuration protection))
- > **2 configurable signal relays for run signals and fault messages**
- > **Slot for Wilo-CIF modules** with interfaces for building automation BA (optional accessories: CIF modules Modbus RTU, Modbus TCP, BACnet MS/TP, BACnet IP, LON, PLR, CANopen)
- > Wilo Net as a Wilo system bus for communication between Wilo products, e.g. **Multi-Flow Adaptation**; twin-head pump operation and Wilo-Smart Gateway
- > Automatic **emergency operation** with definable pump speed for exceptional circumstances, e.g. bus communication or sensor value malfunction
- > **Graphic colour display** (4.3 inches) with one-button manual operation
- > Use the Wilo-Assistant app to read and set operating data and –among other things– set up a commissioning protocol through the Bluetooth interface (no further accessories required)
- > Integrated **dual pump management** (twin-head pumps are prewired) when using 2 single pumps as twin-head pump unit (connection via Wilo Net)
- > Cable break detection when using an analogue signal (in connection with 2–10 V or 4–20 mA)
- > Outdoor installation with weather protection possible in accordance with the installation and operating instructions
- > Pre-set date and time
- > Thermal insulation shell for heating applications

Scope of delivery

- > Pump
- > Optimised Wilo-Connector the same for all sizes
- > 2x threaded cable connection M16 x 1.5
- > 2x gaskets
- > Thermal insulation shell
- > Concise Installation and operating instructions

Optional accessories:

- > ClimaForm cold insulation to avoid the formation of condensate
- > CIF module: Modbus TCP, Modbus RTU, BACnet IP, BACnet MS/TP, LON, PLR, CANopen
- > PT 1000 (B) pipe contact sensor (for domestic hot water)
- > PT 1000 (AA) sensor for installation in immersion well
- > Differential pressure sensor
- > Smart Gateway
- > Stratos MAXO temperature sensor (can be retrofitted for recording and displaying the fluid temperature and using the temperature-controlled control modes T-const., dT-const.)

Operating data

Fluid media	Water
Fluid temperature T	-10 °C
Ambient temperature T	-10 °C
Maximum operating pressure PN	10 bar
Minimum suction head at 50 °C m	5 m
Minimum suction head at 95 °C m	12 m
Minimum suction head at 110 °C	18 m

Motor data

Energy efficiency index (EEI)	0.17
Interference emission	EN 61800-3;2004+A1;2012 /residential area (C1)
Interference immunity	EN 61800-3;2004+A1;2012 /industrial environment (C2)
Mains connection	1~230 V, 50/60 Hz
Power consumption $P_{1\max}$	640 W
Min. speed n_{\min}	650 1/min
Max. speed n_{\max}	3850 1/min
Protection class motor	IPX4D
Threaded cable connection	5 x M16x1.5

Materials

Pump housing	Cast iron
Impeller	PPS-GF40
Shaft	1.4028, DLC-coated
Bearing	Carbon, antimony-impregnated

Installation dimensions

Pipe connection on the suction side DN_s	DN 40
Pipe connection on the discharge side DN_d	DN 40
Port-to-port length L_0	250 mm

Ordering information

Brand	Wilo
Product description	Stratos MAXO 40/0,5-16 PN6/10-R7
Net weight, approx. m	16 kg
Article number	2217952