



DOMESTIC FIXED SPEED-10HM02P-400V

COMPONENT	MATERIAL
PUMP BODY	STAINLESS STEEL
IMPELLER	TECHNOPOLYMER NORYL
DIFFUSER	STAINLESS STEEL
SHAFT	STAINLESS STEEL
ADAPTER	ALUMINIUM
SEAL HOUSING	STAINLESS STEEL
FILL/DRAIN PLUGS	NICKEL-PLATED BRASS
WEAR RING	TECHNOPOLYMER
BOLTS AND SCREWS	STAINLESS STEEL



TECHNICAL DATA

VOLTAGE	400 V	MAX PRESSURE	10 BAR
FREQUENCY	50 Hz	MAX TEMPERATURE	40 °C
POWER	1.1 kW	PROTECTION RATING	IP55
FLC	4.19 A	PART CODE	5050-10HM02P-FS/3

DIMENSIONS

A	B	INLET/OUTPUT
590	650	DN40 FBSP

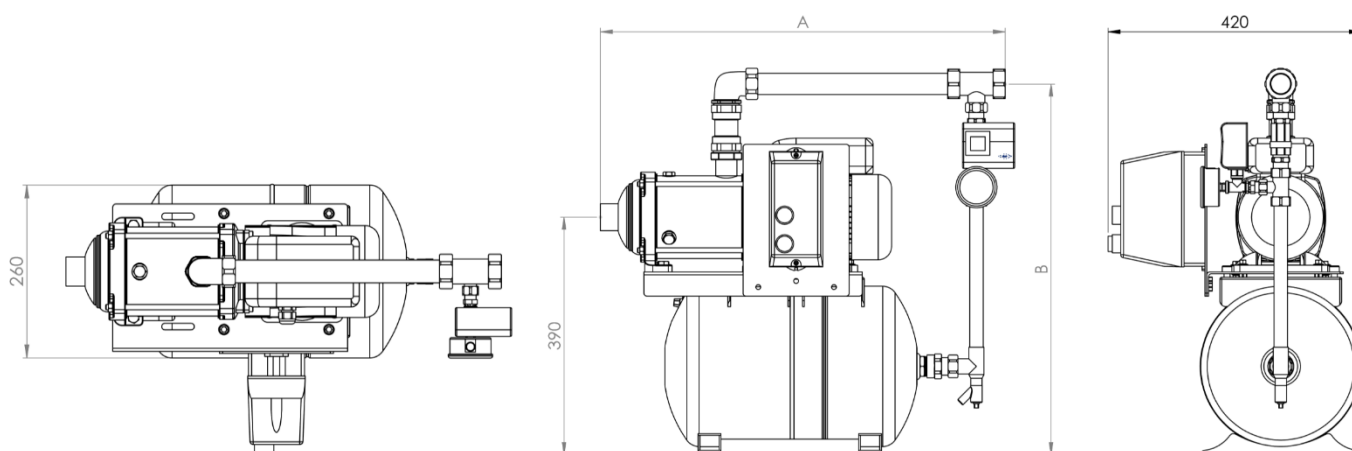



PERFORMANCE CURVE

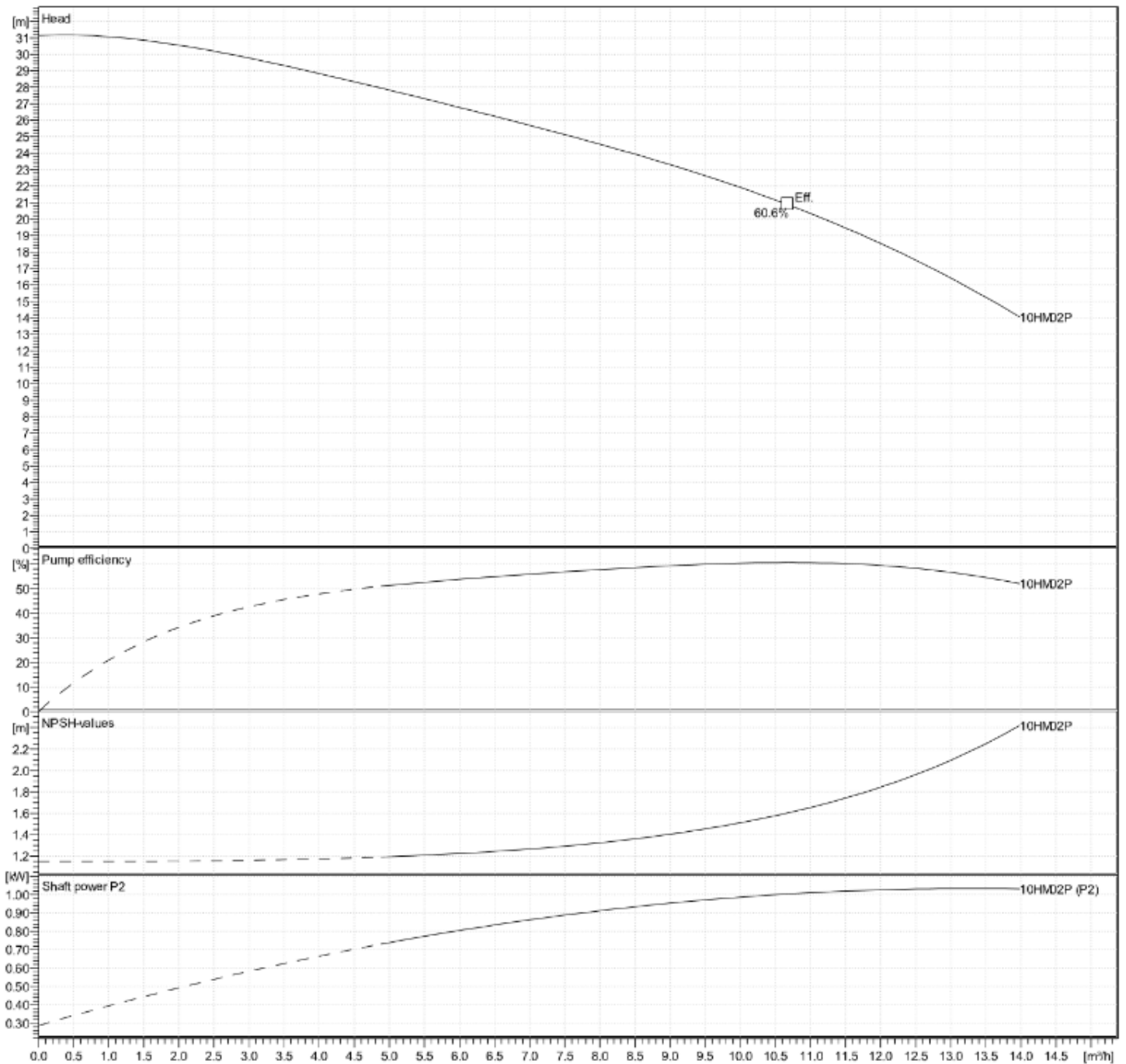

SPECIALITIES Pumps • Booster Sets • Pressurisation • Heating • Cold Water • Heat Exchangers • Service / Repair • Pressure Vessels • Pump Accessories

GM Treble Ltd
New Street, Parkfields,
Wolverhampton. WV4 6AN

Tel: +44 (0)1902 333 111
Fax: +44(0)1902 340 941

www.gmtreble.co.uk
Email: sales@gmtreble.co.uk