



## DOMESTIC FIXED SPEED-3HM08S-400V

COMPONENT	MATERIAL
PUMP BODY	STAINLESS STEEL
IMPELLER	STAINLESS STEEL
DIFFUSER	STAINLESS STEEL
SHAFT	STAINLESS STEEL
ADAPTER	ALUMINIUM
SEAL HOUSING	STAINLESS STEEL
FILL/DRAIN PLUGS	NICKEL-PLATED BRASS
WEAR RING	TECHNOPOLYMER
BOLTS AND SCREWS	STAINLESS STEEL



### TECHNICAL DATA

VOLTAGE	400 V	MAX PRESSURE	10 BAR
FREQUENCY	50 Hz	MAX TEMPERATURE	40 °C
POWER	0.75 kW	PROTECTION RATING	IP55
FLC	2.96 A	PART CODE	5050-3HM08S-FS/3

### DIMENSIONS

A	B	INLET/OUTPUT
630	590	DN25 FBSP

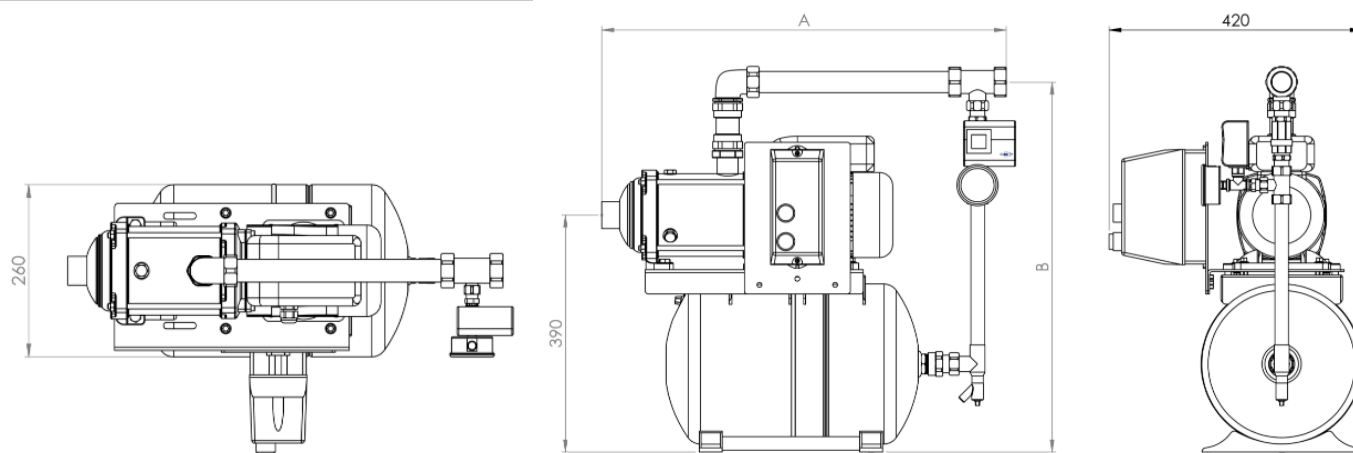



## PERFORMANCE CURVE

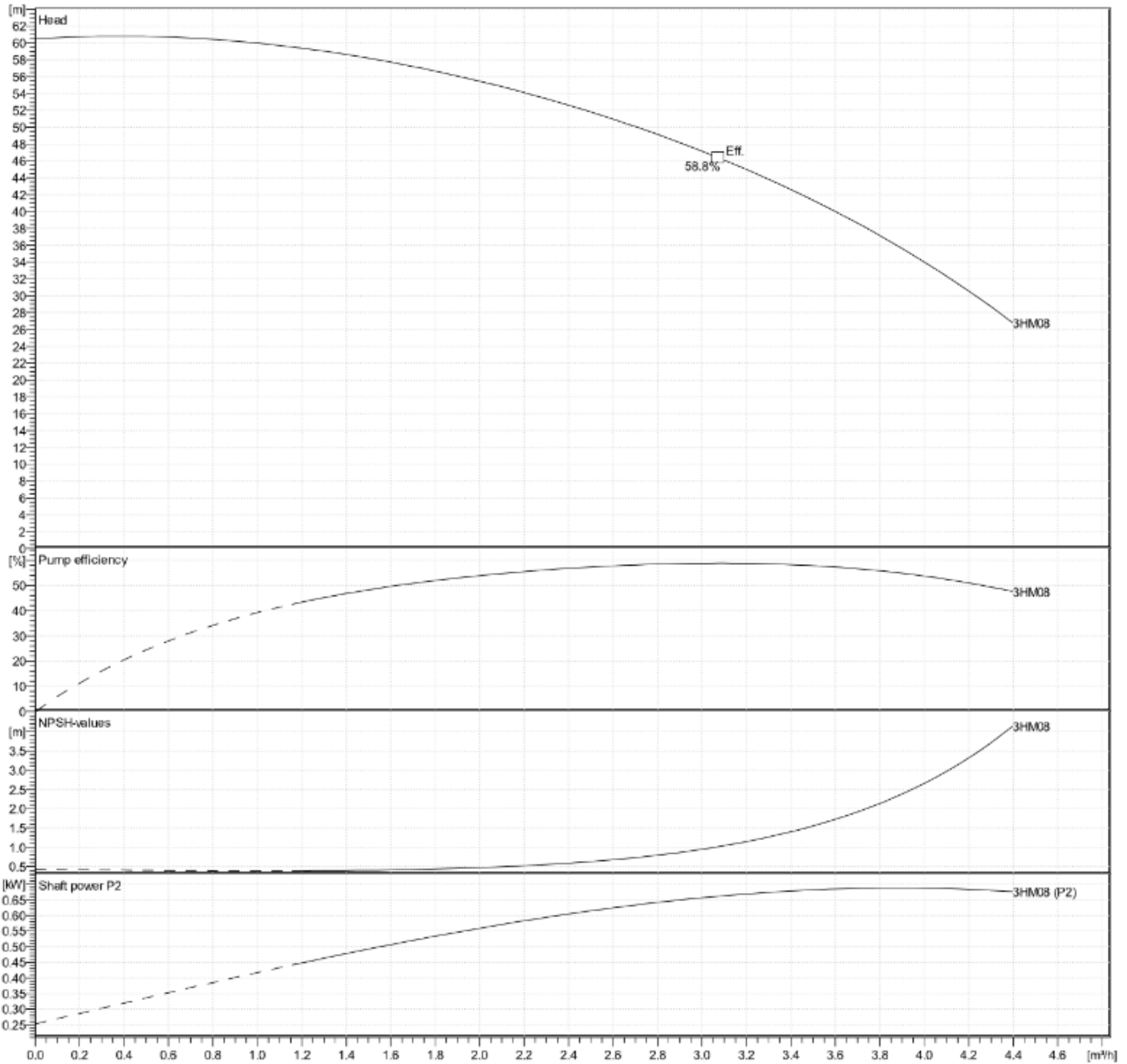

**SPECIALITIES** Pumps • Booster Sets • Pressurisation • Heating • Cold Water • Heat Exchangers • Service / Repair • Pressure Vessels • Pump Accessories

**GM Treble Ltd**  
New Street, Parkfields,  
Wolverhampton. WV4 6AN

Tel: +44 (0)1902 333 111  
Fax: +44(0)1902 340 941

[www.gmtreble.co.uk](http://www.gmtreble.co.uk)  
Email: [sales@gmtreble.co.uk](mailto:sales@gmtreble.co.uk)