



DOMESTIC FIXED SPEED-5HM06S-400V

| COMPONENT | MATERIAL |
|------------------|---------------------|
| PUMP BODY | STAINLESS STEEL |
| IMPELLER | STAINLESS STEEL |
| DIFFUSER | STAINLESS STEEL |
| SHAFT | STAINLESS STEEL |
| ADAPTER | ALUMINIUM |
| SEAL HOUSING | STAINLESS STEEL |
| FILL/DRAIN PLUGS | NICKEL-PLATED BRASS |
| WEAR RING | TECHNOPOLYMER |
| BOLTS AND SCREWS | STAINLESS STEEL |



TECHNICAL DATA

| | | | |
|-----------|--------|-------------------|------------------|
| VOLTAGE | 400 V | MAX PRESSURE | 10 BAR |
| FREQUENCY | 50 Hz | MAX TEMPERATURE | 40 °C |
| POWER | 1.1 kW | PROTECTION RATING | IP55 |
| FLC | 4.19 A | PART CODE | 5050-5HM06S-FS/3 |

DIMENSIONS

| A | B | INLET/OUTPUT |
|-----|-----|--------------|
| 620 | 610 | DN32 FBSP |

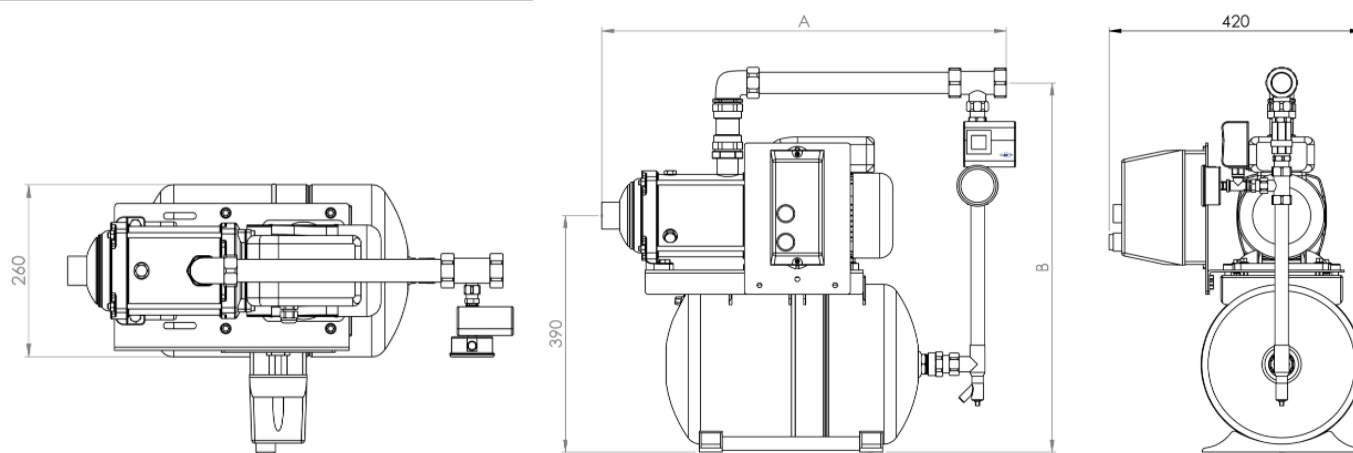



PERFORMANCE CURVE

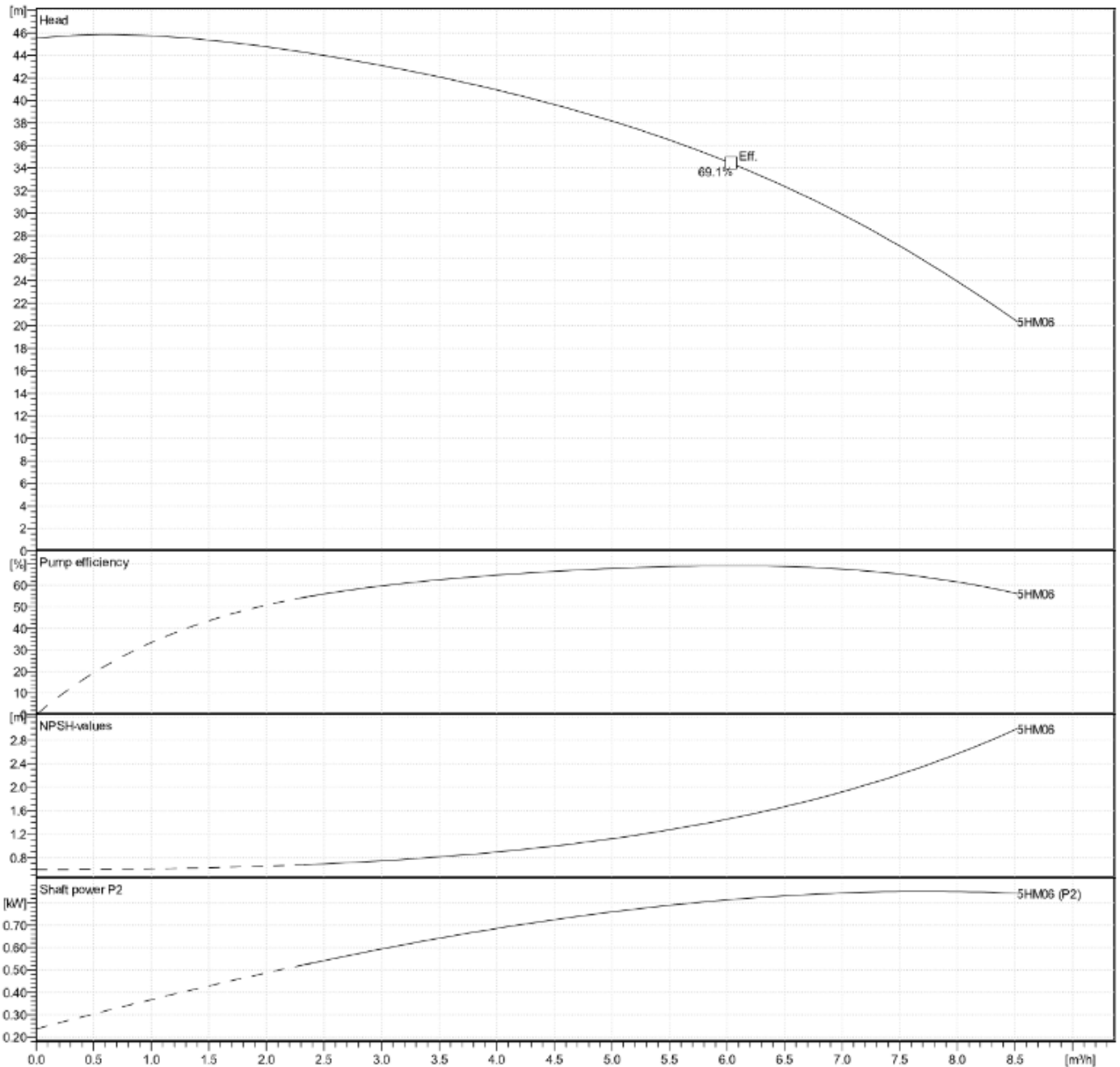

SPECIALITIES Pumps • Booster Sets • Pressurisation • Heating • Cold Water • Heat Exchangers • Service / Repair • Pressure Vessels • Pump Accessories

GM Treble Ltd
New Street, Parkfields,
Wolverhampton. WV4 6AN

Tel: +44 (0)1902 333 111
Fax: +44(0)1902 340 941

www.gmtreble.co.uk
Email: sales@gmtreble.co.uk