

Qty.	Description
------	-------------

1	SE1.50.65.40.2.51D.B
---	----------------------



Note! Product picture may differ from actual product

Product No.: [96047525](#)

Non-self-priming, single-stage, centrifugal pump designed for handling wastewater, process water and unscreened raw sewage.

The pump is designed for intermittent and continuous operation. The liquidless and maintenance free cooling system ensures that the pump can be used for submerged or dry installation. The revolutionary S-tube® impeller provides free spherical passage of solids up to 50 mm and is suitable for wastewater with a dry matter content of up to 3 %. A unique stainless-steel clamp assembling system enables quick and easy disassembly of the pump from the motor unit for service and inspection. No special tools are required. Pipework connection is via a DIN flange.

Further product details

The pump is suitable for both temporary and permanent installation either as free-standing on ring stand, on base stand, on brackets or on an auto-coupling system.

Pump

The pump is fitted with an easy-to-clean stainless-steel motor sleeve (EN 1.4301) that is extremely robust and impact-resistant. Pump housing and impeller is made of cast iron (EN-GJL-250).

All surfaces of the cast iron parts are protected with cathodolysis coating.

The surface of the cast iron pump parts is afterwards painted with environmental friendly powder coating (type NCS 9000N (black), gloss code 30, thickness 100 µm) which ensures high impact and corrosion protection.

The final pump is assembled from already painted parts which ensures that no rust or scale can be formed in grooves between parts, etc.

The S-tube® impeller is providing free spherical passage through the impeller and pump housing and creates a natural extension of the pipework connected to the pump.

The S-tube® impeller is a wet-balanced and tube-shaped channel impeller placed in a pump housing that matches the smooth tube shape leaving no obstructions or dead zones.

The key to the S-tube® design is simplicity, with no cutting or moving functions that can get worn over time, thereby ensuring constant, superior efficiency. The simple design means lower life cycle costs because abrasive wear is reduced and there are fewer clogging incidents.

Qty. Description

1



The shaft seal consists of two mechanical seals that ensure a reliable sealing between the pumped liquid and motor. The shaft seals are incorporated in a single-unit cartridge shaft seal system that is easy to replace in the field without use of special tools.

The combination of the primary and secondary seals in a cartridge shaft seal system results in a shorter assembly length compared to conventional shaft seals.

- Primary seal: Silicon carbide/silicon carbide (SiC/SiC)
- Secondary seal: Carbon/Ceramics

The shaft seal is bidirectional, meaning it operates correctly in case of backflow through the pump.



The pump is approved according to EN12050-2.

Motor

The motor is a watertight, totally encapsulated motor supplied with a 10 m power cable. The stainless steel plug is fastened with a union nut. This nut and the O-rings provide sealing against ingress of the liquid.

The plug is polyurethane-embedded, ensuring a watertight and durable seal around the leads of the cable. This prevents the ingress of water into the motor through the cable in case of cable breakage or adverse handling in connection with installation or service.

A compact motor construction with a short shaft reduces vibrations, resulting in an increased efficiency and lifetime of the shaft seal and ball bearings.

The motor features built-in thermal protection to protect the motor against overheating and ensure the reliability.

A solid-block stator housing with built-in cooling conduits, efficiently transfers excess heat to the pumped liquid via a solid cast intermediate cooling flange, that is in direct contact with the pumped liquid.

This allows for continuous operation even in a dry installation.

An extremely robust impact-resistant stainless-steel jacket with an easy-to-clean smooth surface is fitted on the top of the solid-block stator housing.

The pump is designed for speed-controlled operation to keep the energy consumption at a minimum.

To avoid the risk of sedimentation in the pipes, we recommend that you operate the speed-controlled pump within a speed range of 30 % to 100 % and at a flow rate above 1 m/s.

Controls:

Moisture sensor:	without moisture sensors
Water-in-oil sensor:	without water-in-oil sensor
Temp. sensor:	N

Qty.	Description
1	<p>Liquid: Liquid temperature range: 0 .. 40 °C Density: 998.2 kg/m³</p> <p>Technical: Max flow: 24.4 l/s Type of impeller: S-TUBE Maximum particle size: 50 mm Primary shaft seal: SIC/SIC Max. hydraulic efficiency: 65 % Approvals: EN12050-2 Curve tolerance: ISO9906:2012 3B2</p> <p>Materials: Pump housing: EN 1561 EN-GJL-250 Impeller: Cast iron EN 5.1301 EN-GJL-250</p> <p>Installation: Maximum operating pressure: 6 bar Flange standard: DIN Pump outlet: DN 65 Pressure rating: PN 10 Maximum installation depth: 20 m Auto-coupling: 96090992</p> <p>Electrical data: Power input - P1: 4.8 kW Rated power - P2: 4 kW Mains frequency: 50 Hz Rated voltage: 3 x 380-415 V Voltage tolerance: +6/-10 % Max starts per. hour: 20 Rated current: 8.7-8.5 A Rated current at 3/4 load: 6.7 A Rated current at 1/2 load: 5.4 A Starting current: 71 A Rated current at no load: 3.9 A Cos phi - power factor: 0.84 Cos phi - p.f. at no load: 0.15 Cos phi - p.f. at 3/4 load: 0.78 Cos phi - p.f. at 1/2 load: 0.68 Rated speed: 2925 rpm Locked-rotor torque: 40 Nm Breakdown torque: 54 Nm Moment of inertia: 0.019 kg m² Motor efficiency at full load: 83.3 % Motor efficiency at 3/4 load: 82.4 % Motor efficiency at 1/2 load: 79.2 % Number of poles: 2 Start. method: star/delta Enclosure class (IEC 34-5): IP68 Insulation class (IEC 85): F Explosion proof: no Length of cable: 10 m Cable type: LYNIFLEX Type of cable plug: No plug</p> <p>Others:</p>



Company name:

Created by:

Phone:

Date:

28/12/2022

Qty.	Description
------	-------------

1	Net weight: 139 kg
	Gross weight: 160 kg
	Danish VVS No.: 391287133

96047525 SE1.50.65.40.2.51D.B 50 Hz

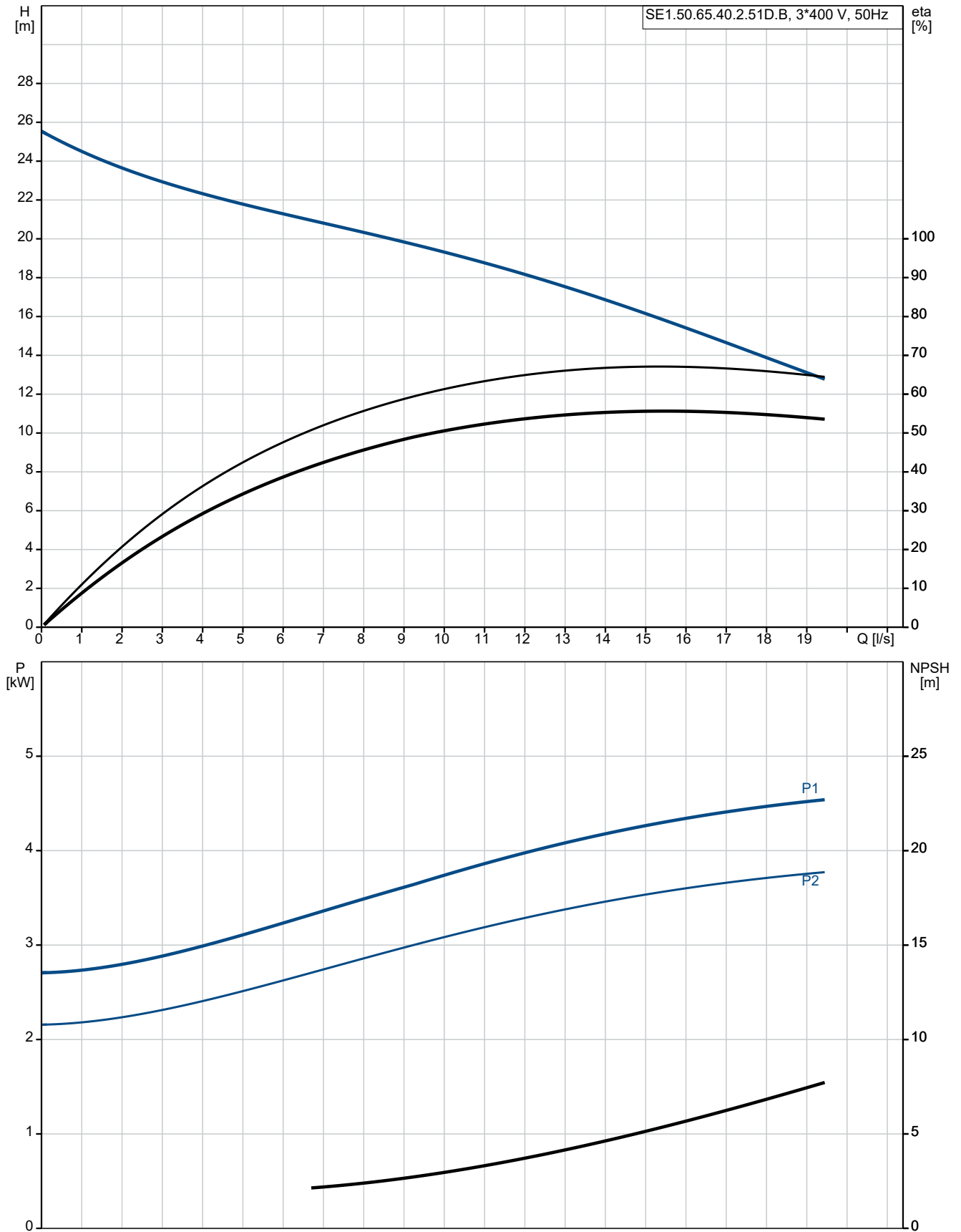

Description	Value
General information:	
Product name:	SE1.50.65.40.2.51D.B
Product No:	96047525
EAN number:	5700395045567
Technical:	
Max flow:	24.4 l/s
Head max:	25.5 m
Type of impeller:	S-TUBE
Maximum particle size:	50 mm
Primary shaft seal:	SIC/SIC
Max. hydraulic efficiency:	65 %
Approvals:	EN12050-2
Curve tolerance:	ISO9906:2012 3B2
Cooling jacket:	with cooling jacket
Materials:	
Pump housing:	EN 1561 EN-GJL-250
Impeller:	Cast iron
Impeller:	EN 5.1301 EN-GJL-250
Installation:	
Maximum operating pressure:	6 bar
Flange standard:	DIN
Pump outlet:	DN 65
Pressure rating:	PN 10
Maximum installation depth:	20 m
Inst dry/wet:	DRY/SUBMERGED
Installation:	horizontal or vertical
Auto-coupling:	96090992
Liquid:	
Liquid temperature range:	0 .. 40 °C
Density:	998.2 kg/m ³
Electrical data:	
Power input - P1:	4.8 kW
Rated power - P2:	4 kW
Mains frequency:	50 Hz
Rated voltage:	3 x 380-415 V
Voltage tolerance:	+6/-10 %
Max starts per. hour:	20
Rated current:	8.7-8.5 A
Rated current at 3/4 load:	6.7 A
Rated current at 1/2 load:	5.4 A
Starting current:	71 A
Rated current at no load:	3.9 A
Cos phi - power factor:	0.84
Cos phi - p.f. at no load:	0.15
Cos phi - p.f. at 3/4 load:	0.78
Cos phi - p.f. at 1/2 load:	0.68
Rated speed:	2925 rpm
Locked-rotor torque:	40 Nm
Breakdown torque:	54 Nm
Moment of inertia:	0.019 kg m ²
Motor efficiency at full load:	83.3 %
Motor efficiency at 3/4 load:	82.4 %
Motor efficiency at 1/2 load:	79.2 %
Number of poles:	2
Start. method:	star/delta
Enclosure class (IEC 34-5):	IP68
Insulation class (IEC 85):	F
Explosion proof:	no

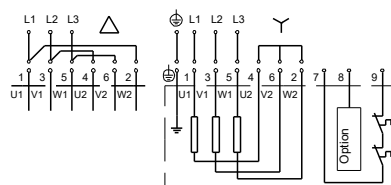
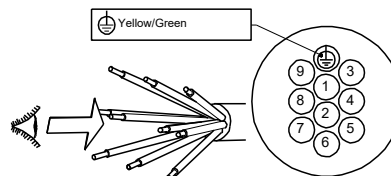
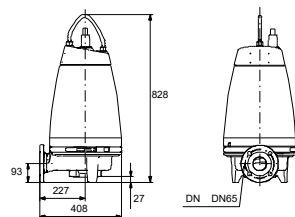
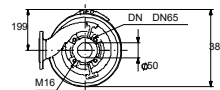
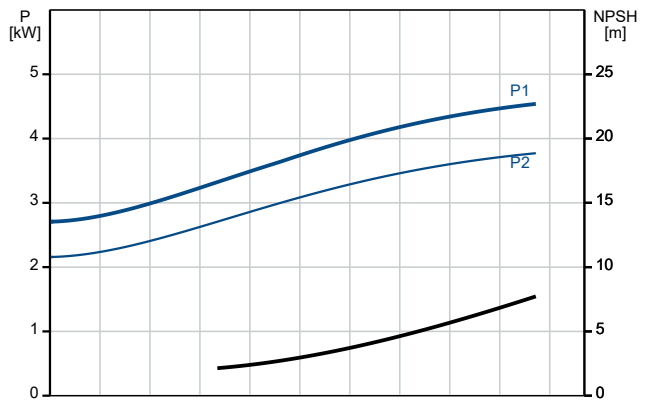
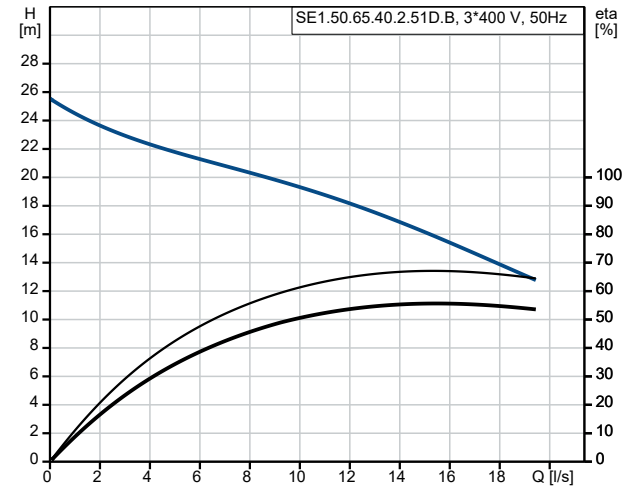



Company name:

Created by:

Phone:

Date:

28/12/2022

Description	Value
Built-in motor protection:	THERMAL SWITCH
Thermal protec:	internal
Length of cable:	10 m
Cable type:	LYNIFLEX
Type of cable plug:	No plug
Controls:	
Control box:	not included
Moisture sensor:	without moisture sensors
Water-in-oil sensor:	without water-in-oil sensor
Temp. sensor:	N
Others:	
Net weight:	139 kg
Gross weight:	160 kg
Danish VVS No.:	391287133

96047525 SE1.50.65.40.2.51D.B 50 Hz

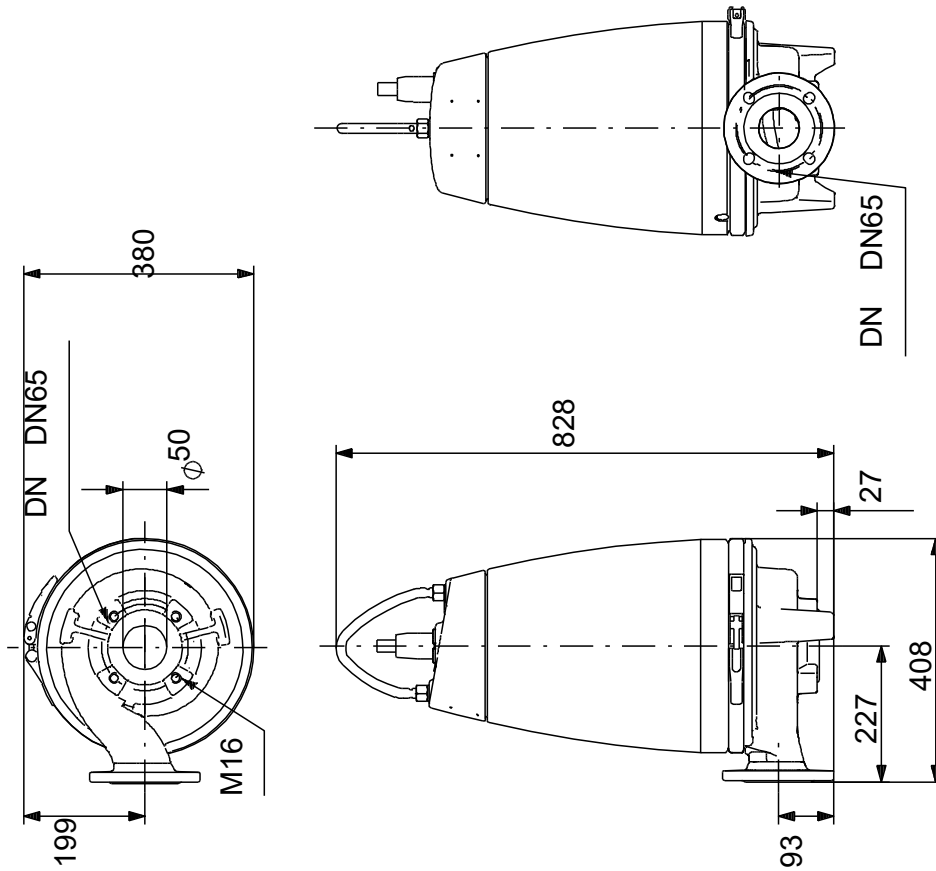

Note! All units are in [mm] unless others are stated.
Disclaimer: This simplified dimensional drawing does not show all details.

96047525 SE1.50.65.40.2.51D.B 50 Hz

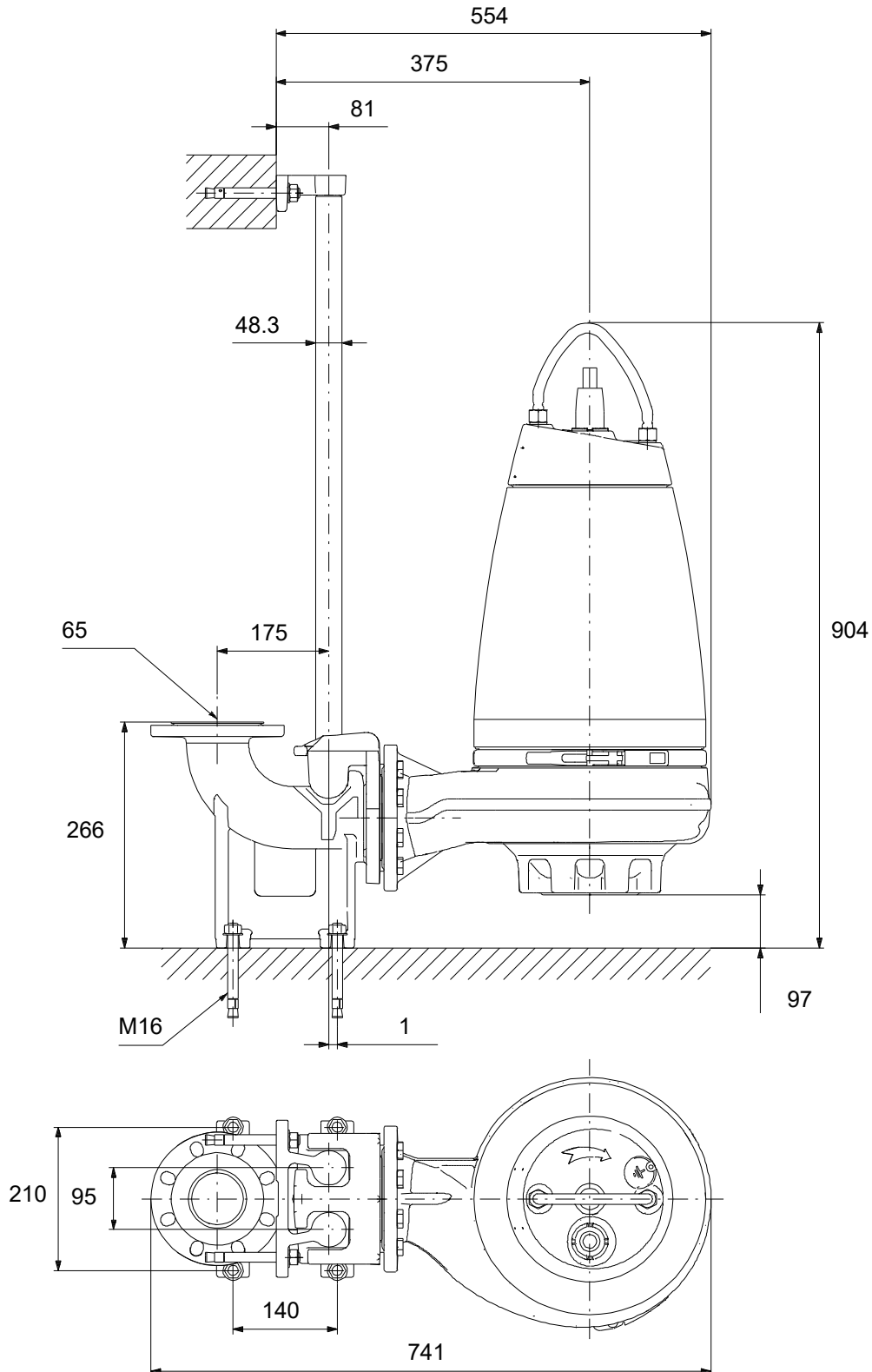

Note! All units are in [mm] unless others are stated.
Disclaimer: This simplified dimensional drawing does not show all details.

96047525 SE1.50.65.40.2.51D.B 50 Hz

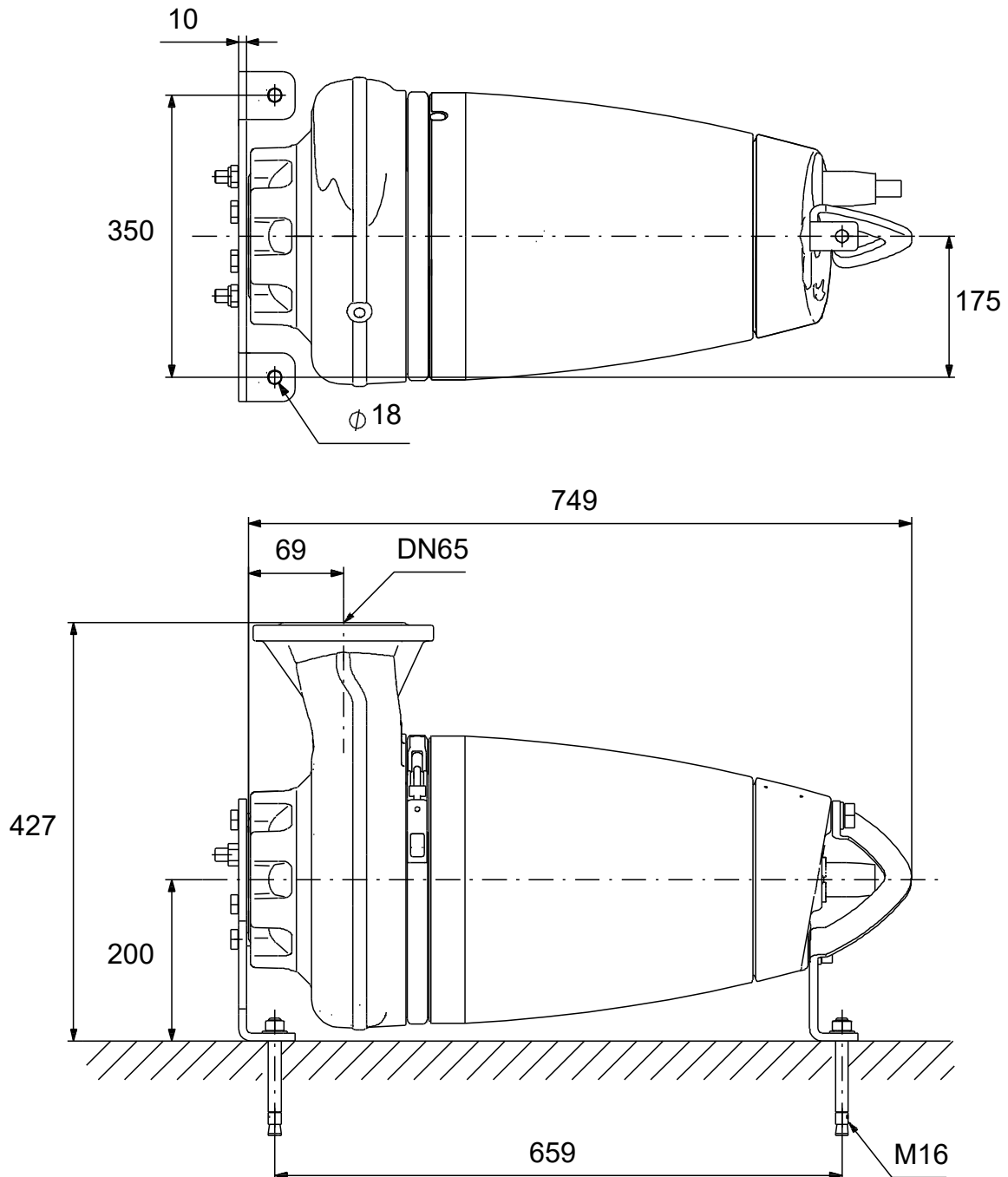

Note! All units are in [mm] unless others are stated.
Disclaimer: This simplified dimensional drawing does not show all details.

96047525 SE1.50.65.40.2.51D.B 50 Hz

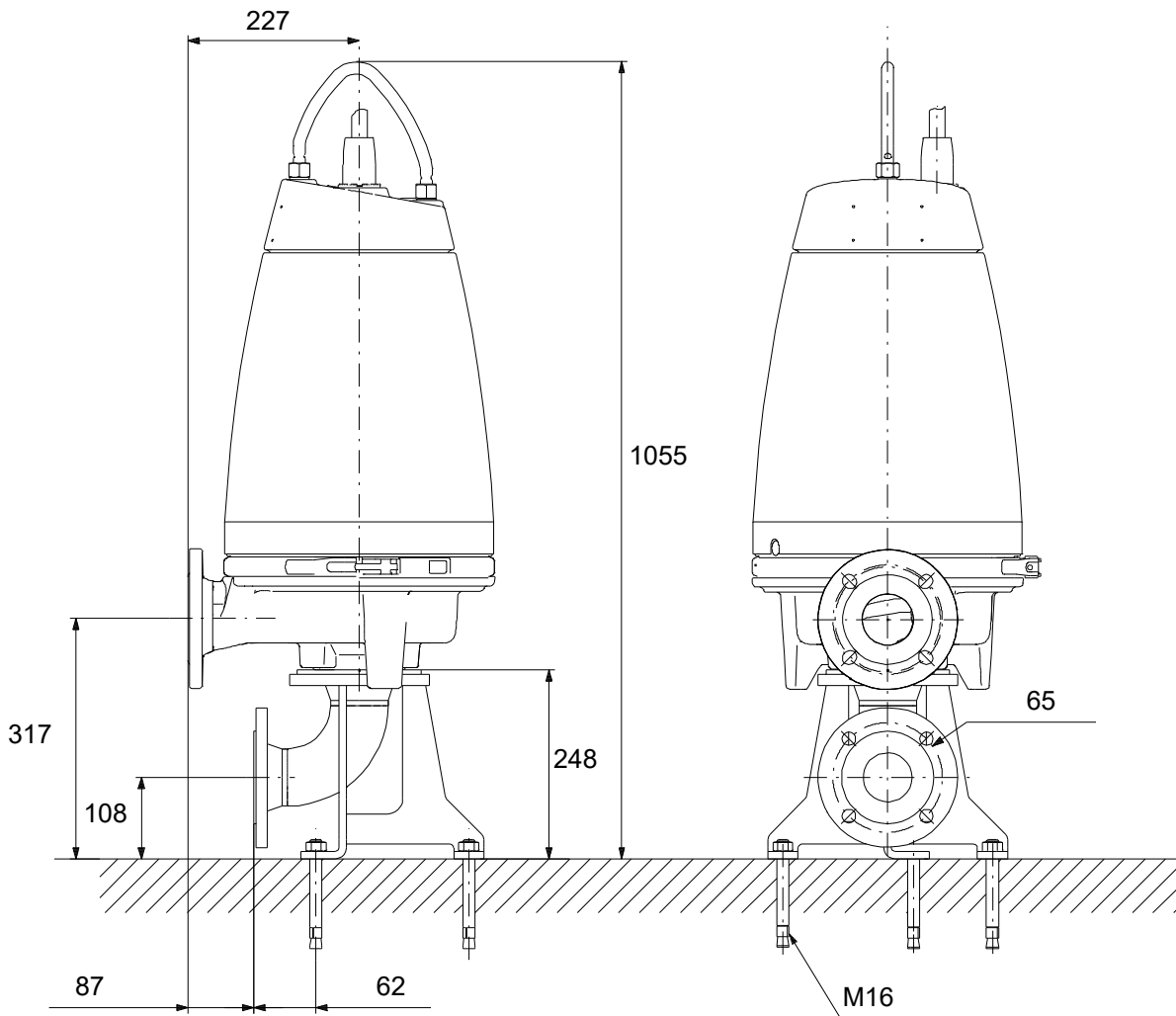
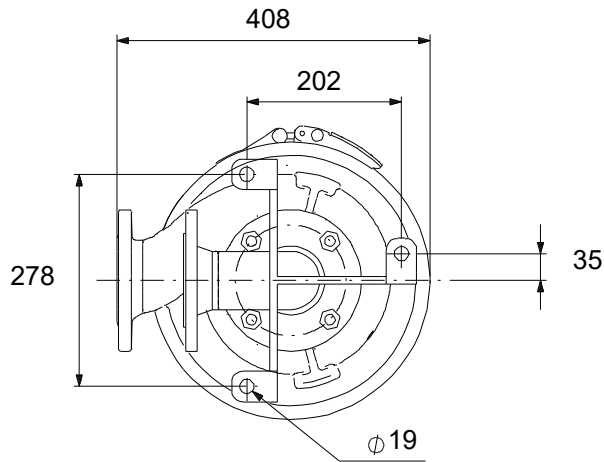

Note! All units are in [mm] unless others are stated.
Disclaimer: This simplified dimensional drawing does not show all details.

96047525 SE1.50.65.40.2.51D.B 50 Hz

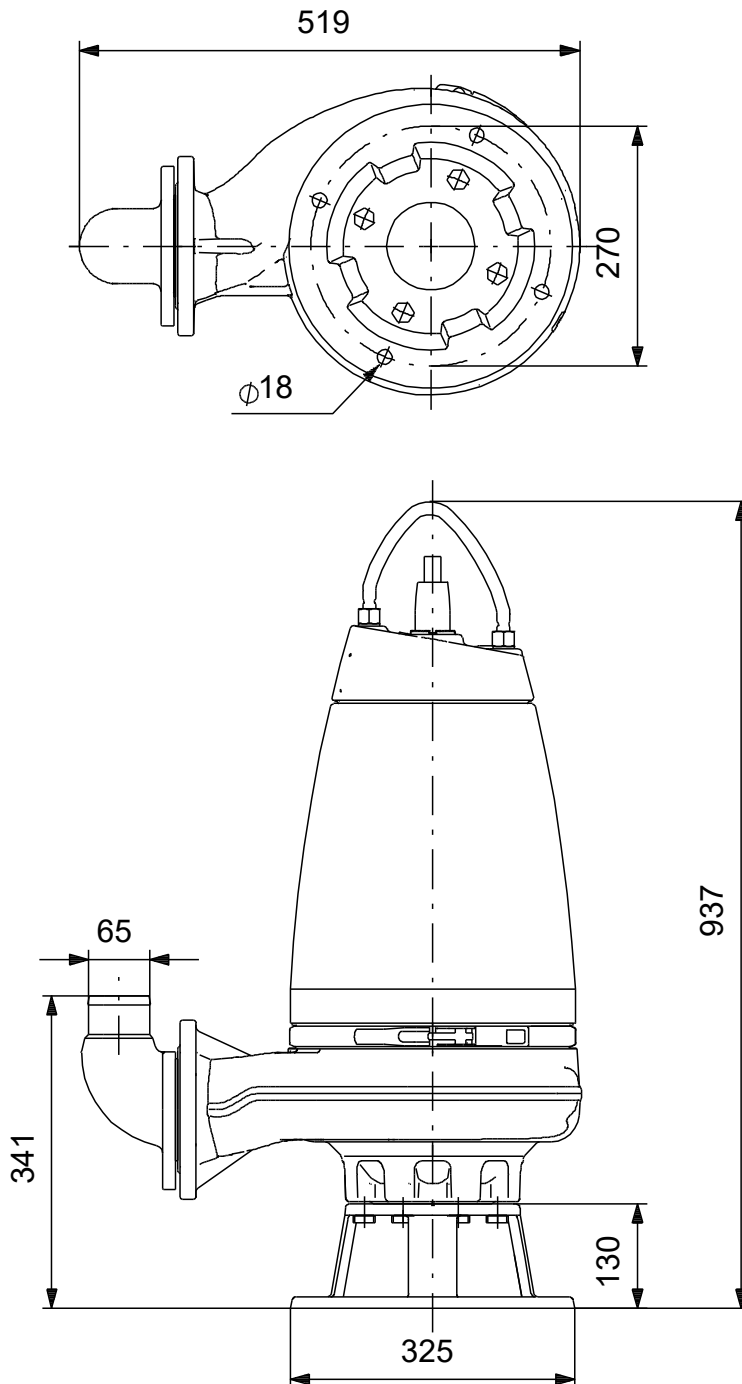

Note! All units are in [mm] unless others are stated.
Disclaimer: This simplified dimensional drawing does not show all details.

96047525 SE1.50.65.40.2.51D.B 50 Hz



Note! All units are in [mm] unless others are stated.

