

Qty.	Description
1	<p data-bbox="204 163 475 185"><b>MTR 1-4/4 A-W-A-HUUV</b></p>  <p data-bbox="204 483 478 506">Product No.: On request</p> <p data-bbox="204 544 1430 618">Multistage, immersible, self-priming, centrifugal pump for vertical installation in tanks etc. The pump head and base are in cast iron – all other wetted parts are in stainless steel. The pump has the following characteristics:</p> <ul data-bbox="240 629 1114 741" style="list-style-type: none"> <li>• Dimensions according to DIN 5440.</li> <li>• Impellers, intermediate chambers and spline shaft are made of Stainless steel.</li> <li>• Mechanical shaft seal according to EN 12756.</li> <li>• Power transmission via sintered metal split coupling.</li> </ul> <p data-bbox="204 750 1430 797">A cartridge shaft seal ensures high reliability, safe handling, and easy access and service. The pump is fitted with a 3-phase, fan-cooled asynchronous motor.</p> <p data-bbox="204 837 300 860"><b>Controls:</b></p> <p data-bbox="204 869 635 891">Frequency converter: NONE</p> <p data-bbox="204 927 277 949"><b>Liquid:</b></p> <p data-bbox="204 958 635 981">Pumped liquid: Water</p> <p data-bbox="204 990 689 1012">Liquid temperature range: -10 .. 90 °C</p> <p data-bbox="204 1021 635 1043">Selected liquid temperature: 20 °C</p> <p data-bbox="204 1052 695 1075">Density: 998.2 kg/m<sup>3</sup></p> <p data-bbox="204 1111 316 1133"><b>Technical:</b></p> <p data-bbox="204 1142 817 1164">Pump speed on which pump data are based: 2873 rpm</p> <p data-bbox="204 1173 651 1196">Rated flow: 30 l/min</p> <p data-bbox="204 1205 641 1227">Rated head: 19.2 m</p> <p data-bbox="204 1236 577 1258">Chambers: 4</p> <p data-bbox="204 1267 577 1290">Drainage back to tank: N</p> <p data-bbox="204 1299 647 1321">Pump orientation: Vertical</p> <p data-bbox="204 1330 635 1352">Code for shaft seal: HUUV</p> <p data-bbox="204 1361 657 1384">Approvals: CE,EAC</p> <p data-bbox="204 1393 759 1415">Curve tolerance: ISO9906:2012 3B</p> <p data-bbox="204 1451 309 1473"><b>Materials:</b></p> <p data-bbox="204 1482 801 1550">Pump head: Cast iron EN 1561 EN-GJL-200 ASTM A48-25B</p> <p data-bbox="204 1559 721 1639">Impeller: Stainless steel EN 1.4301 AISI 304</p> <p data-bbox="204 1675 325 1697"><b>Installation:</b></p> <p data-bbox="204 1706 628 1729">t max amb: 60 °C</p> <p data-bbox="204 1738 635 1760">Maximum operating pressure: 25 bar</p> <p data-bbox="204 1769 721 1792">Max pressure at stated temp: 25 bar / 90 °C</p> <p data-bbox="204 1800 746 1823">Type of connection: G internal thread</p> <p data-bbox="204 1832 673 1854">Size of outlet connection: 1 1/4 inch</p> <p data-bbox="204 1863 657 1886">Immersion depth: 196 mm</p> <p data-bbox="204 1895 625 1917">Flange size for motor: FT85</p> <p data-bbox="204 1953 363 1975"><b>Electrical data:</b></p> <p data-bbox="204 1984 609 2007">Motor standard: IEC</p> <p data-bbox="204 2016 609 2038">Motor type: 71A</p> <p data-bbox="204 2047 609 2069">IE Efficiency class: IE3</p> <p data-bbox="204 2078 657 2101">Rated power - P2: 0.37 kW</p>

Qty.	Description																																																
1	<table> <tr> <td>Mains frequency:</td> <td>50 Hz</td> </tr> <tr> <td>Suitable for 50/60 Hz:</td> <td>N</td> </tr> <tr> <td>Rated voltage:</td> <td>3 x 220-240D/380-415Y V</td> </tr> <tr> <td>Rated current:</td> <td>1.74/1.00 A</td> </tr> <tr> <td>Starting current:</td> <td>490-530 %</td> </tr> <tr> <td>Cos phi - power factor:</td> <td>0.80-0.70</td> </tr> <tr> <td>Rated speed:</td> <td>2850-2880 rpm</td> </tr> <tr> <td>Efficiency:</td> <td>IE3 73,8%</td> </tr> <tr> <td>Motor efficiency at full load:</td> <td>73.8 %</td> </tr> <tr> <td>Motor efficiency at 3/4 load:</td> <td>79.0 %</td> </tr> <tr> <td>Motor efficiency at 1/2 load:</td> <td>75.5 %</td> </tr> <tr> <td>Number of poles:</td> <td>2</td> </tr> <tr> <td>Enclosure class (IEC 34-5):</td> <td>55 Dust/Jetting</td> </tr> <tr> <td>Insulation class (IEC 85):</td> <td>F</td> </tr> <tr> <td>Motor No:</td> <td>85805102</td> </tr> <tr> <td colspan="2">Others:</td> </tr> <tr> <td>Terminal box position:</td> <td>6</td> </tr> <tr> <td>Minimum efficiency index, MEI ≥:</td> <td>0.70</td> </tr> <tr> <td>Net weight:</td> <td>13 kg</td> </tr> <tr> <td>Gross weight:</td> <td>16.1 kg</td> </tr> <tr> <td>Shipping volume:</td> <td>0.045 m<sup>3</sup></td> </tr> <tr> <td>Danish VVS No.:</td> <td>386961004</td> </tr> <tr> <td>Country of origin:</td> <td>HU</td> </tr> <tr> <td>Custom tariff no.:</td> <td>84137075</td> </tr> </table>	Mains frequency:	50 Hz	Suitable for 50/60 Hz:	N	Rated voltage:	3 x 220-240D/380-415Y V	Rated current:	1.74/1.00 A	Starting current:	490-530 %	Cos phi - power factor:	0.80-0.70	Rated speed:	2850-2880 rpm	Efficiency:	IE3 73,8%	Motor efficiency at full load:	73.8 %	Motor efficiency at 3/4 load:	79.0 %	Motor efficiency at 1/2 load:	75.5 %	Number of poles:	2	Enclosure class (IEC 34-5):	55 Dust/Jetting	Insulation class (IEC 85):	F	Motor No:	85805102	Others:		Terminal box position:	6	Minimum efficiency index, MEI ≥:	0.70	Net weight:	13 kg	Gross weight:	16.1 kg	Shipping volume:	0.045 m <sup>3</sup>	Danish VVS No.:	386961004	Country of origin:	HU	Custom tariff no.:	84137075
Mains frequency:	50 Hz																																																
Suitable for 50/60 Hz:	N																																																
Rated voltage:	3 x 220-240D/380-415Y V																																																
Rated current:	1.74/1.00 A																																																
Starting current:	490-530 %																																																
Cos phi - power factor:	0.80-0.70																																																
Rated speed:	2850-2880 rpm																																																
Efficiency:	IE3 73,8%																																																
Motor efficiency at full load:	73.8 %																																																
Motor efficiency at 3/4 load:	79.0 %																																																
Motor efficiency at 1/2 load:	75.5 %																																																
Number of poles:	2																																																
Enclosure class (IEC 34-5):	55 Dust/Jetting																																																
Insulation class (IEC 85):	F																																																
Motor No:	85805102																																																
Others:																																																	
Terminal box position:	6																																																
Minimum efficiency index, MEI ≥:	0.70																																																
Net weight:	13 kg																																																
Gross weight:	16.1 kg																																																
Shipping volume:	0.045 m <sup>3</sup>																																																
Danish VVS No.:	386961004																																																
Country of origin:	HU																																																
Custom tariff no.:	84137075																																																

# On request MTR 1-4/4 A-W-A-HUUV 50 Hz

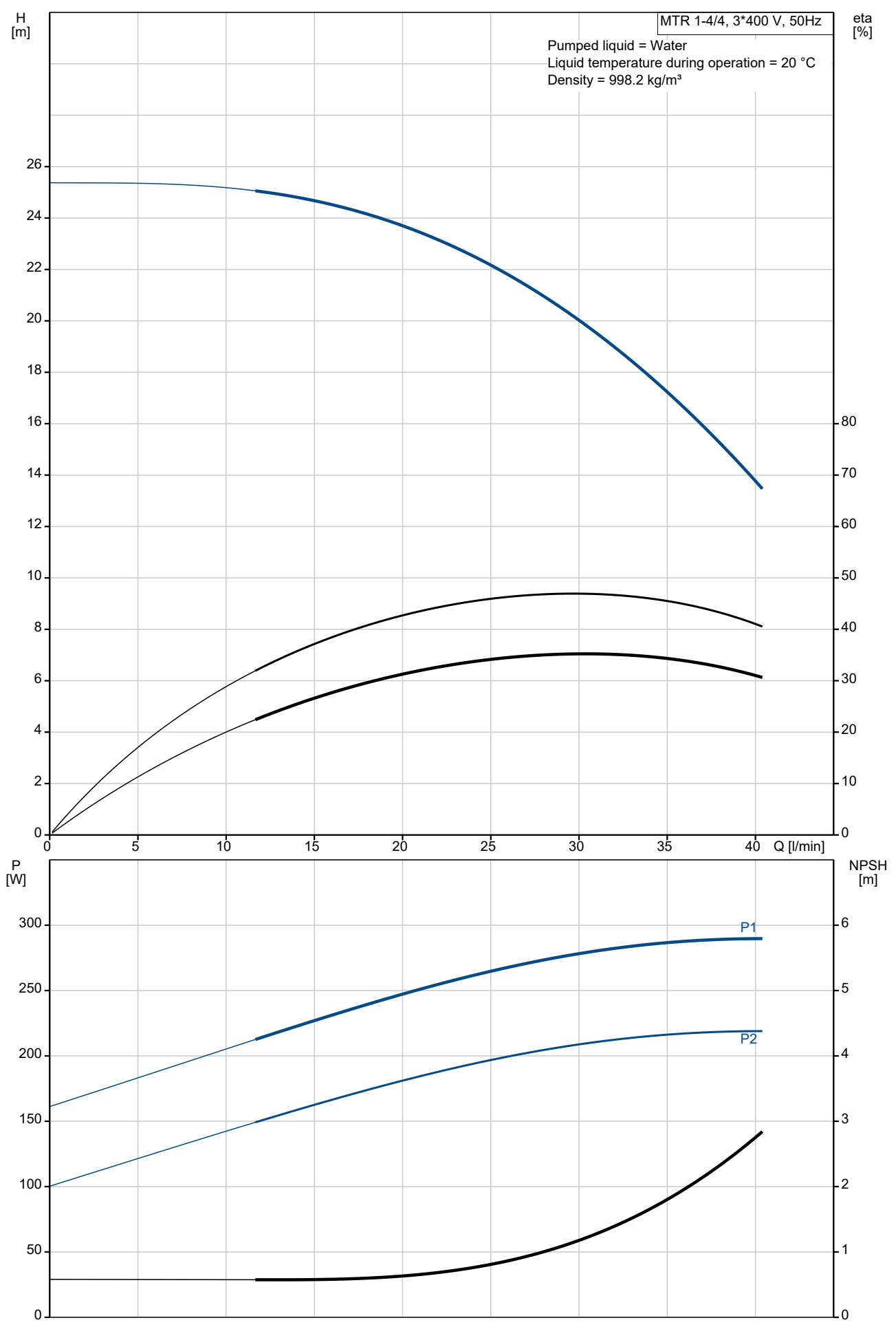

Description	Value
<b>General information:</b>	
Product name:	MTR 1-4/4 A-W-A-HUUUV
Product No:	On request
EAN number:	On request
<b>Technical:</b>	
Pump speed on which pump data are based:	2873 rpm
Rated flow:	30 l/min
Rated head:	19.2 m
Chambers:	4
Impellers:	4
Number of reduced-diameter impellers:	0
Drainage back to tank:	N
Pump orientation:	Vertical
Code for shaft seal:	HUUUV
Approvals:	CE, EAC
Curve tolerance:	ISO9906:2012 3B
Pump version:	A
Model:	A
<b>Materials:</b>	
Pump head:	Cast iron
Pump head:	EN 1561 EN-GJL-200
Pump head:	ASTM A48-25B
Impeller:	Stainless steel
Impeller:	EN 1.4301
Impeller:	AISI 304
Material code:	A
<b>Installation:</b>	
t max amb:	60 °C
Maximum operating pressure:	25 bar
Max pressure at stated temp:	25 bar / 90 °C
Type of connection:	G internal thread
Size of outlet connection:	1 1/4 inch
Immersion depth:	196 mm
Flange size for motor:	FT85
Connect code:	W
<b>Liquid:</b>	
Pumped liquid:	Water
Liquid temperature range:	-10 .. 90 °C
Selected liquid temperature:	20 °C
Density:	998.2 kg/m <sup>3</sup>
<b>Electrical data:</b>	
Motor standard:	IEC
Motor type:	71A
IE Efficiency class:	IE3
Rated power - P2:	0.37 kW
Mains frequency:	50 Hz
Suitable for 50/60 Hz:	N
Rated voltage:	3 x 220-240D/380-415Y V
Rated current:	1.74/1.00 A
Starting current:	490-530 %
Cos phi - power factor:	0.80-0.70
Rated speed:	2850-2880 rpm
Efficiency:	IE3 73,8%
Motor efficiency at full load:	73.8 %
Motor efficiency at 3/4 load:	79.0 %
Motor efficiency at 1/2 load:	75.5 %
Number of poles:	2
Enclosure class (IEC 34-5):	55 Dust/Jetting
Insulation class (IEC 85):	F
Built-in motor protection:	NONE
Motor No:	85805102
<b>Controls:</b>	

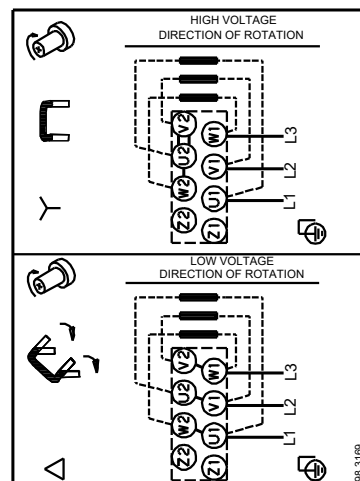
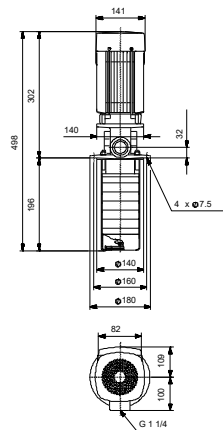
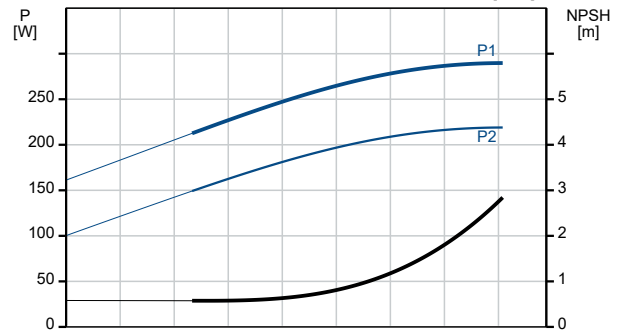
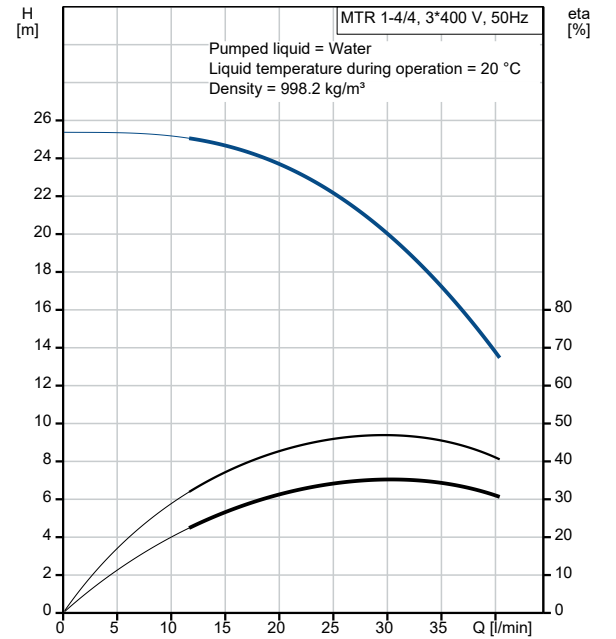

Description	Value
Frequency converter:	NONE
<b>Others:</b>	
Terminal box position:	6
Minimum efficiency index, MEI ≥:	0.70
Net weight:	13 kg
Gross weight:	16.1 kg
Shipping volume:	0.045 m <sup>3</sup>
Danish VVS No.:	386961004
Country of origin:	HU
Custom tariff no.:	84137075

# On request MTR 1-4/4 A-W-A-HUUUV 50 Hz

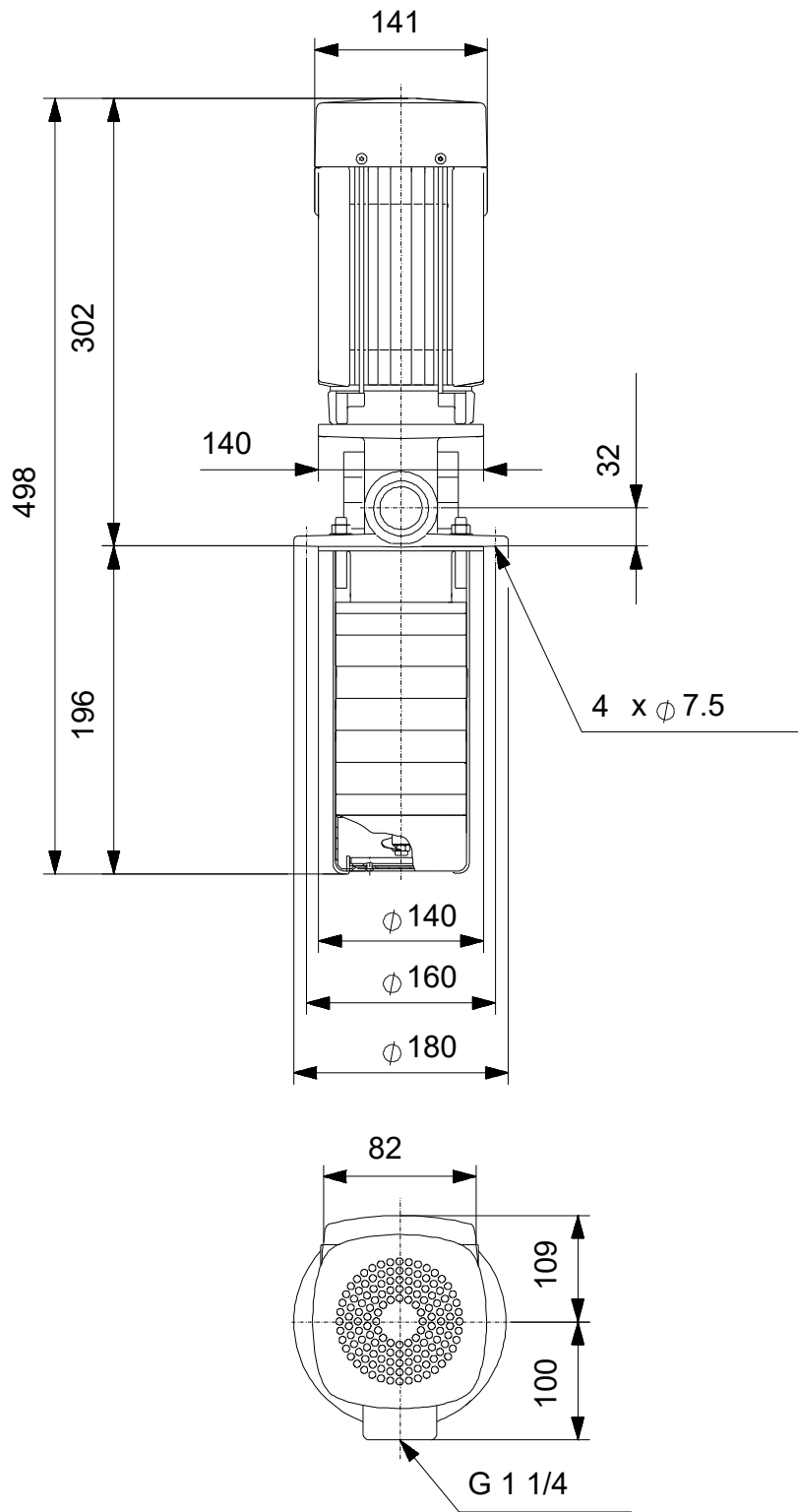

Note! All units are in [mm] unless others are stated.  
Disclaimer: This simplified dimensional drawing does not show all details.

On request MTR 1-4/4 A-W-A-HUUV 50 Hz



Note! All units are in [mm] unless others are stated.

**Order Data:**

Position	Your pos.	Product name	Amount	Product No	Total
		MTR 1-4/4	1	On request	Price on request