

Qty.	Description
1	CRN 64-2-2 A-F-H-E-HQQE
	
	<p>Note! Product picture may differ from actual product</p>
	<p>Product No.: On request</p>
	<p>Vertical, multistage centrifugal pump with inlet and outlet ports on same the level (inline). Pump materials in contact with the liquid are in high-grade stainless steel. A cartridge shaft seal ensures high reliability, safe handling, and easy access and service. Power transmission is via a rigid split coupling. Pipe connection is via DIN flanges.</p>
	<p>The pump is fitted with a 3-phase, fan-cooled asynchronous motor.</p>
	<p>Liquid: Pumped liquid: Water Liquid temperature range: -40 .. 120 °C Selected liquid temperature: 20 °C Density: 998.2 kg/m³</p>
	<p>Technical: Pump speed on which pump data are based: 2919 rpm Rated flow: 64 m³/h Rated head: 29.2 m Pump orientation: Vertical Shaft seal arrangement: Single Code for shaft seal: HQQE Approvals: CE,EAC,UKCA,SEPRO Approvals for drinking water: WRAS,ACS Curve tolerance: ISO9906:2012 3B</p>
	<p>Materials: Base: Stainless steel EN 1.4408 AISI 316 Impeller: Stainless steel EN 1.4401 AISI 316 Bearing: SIC Support bearing: Graflon</p>
	<p>Installation: t max amb: 60 °C Maximum operating pressure: 16 bar Max pressure at stated temp: 16 bar / 120 °C 16 bar / -40 °C</p>
	<p>Type of connection: DIN Size of inlet connection: DN 100 Size of outlet connection: DN 100 Pressure rating for connection: PN 16 Flange size for motor: FF265</p>
	<p>Electrical data: Motor standard: IEC Motor type: 132SB IE Efficiency class: IE3 Rated power - P2: 7.5 kW Power (P2) required by pump: 7.5 kW Mains frequency: 50 Hz</p>

Qty.	Description
1	<p>Rated voltage: 3 x 380-415D/660-690Y V Rated current: 14,4-14,0/8,30-8,10 A Starting current: 780-910 % Cos phi - power factor: 0.88-0.82 Rated speed: 2910-2920 rpm Efficiency: IE3 90,1% Motor efficiency at full load: 90.1-90.4 % Motor efficiency at 3/4 load: 90.8 % Motor efficiency at 1/2 load: 90.8 % Number of poles: 2 Enclosure class (IEC 34-5): 55 Dust/Jetting Insulation class (IEC 85): F Motor No: 85U17522</p> <p>Controls: Frequency converter: NONE</p> <p>Others: Minimum efficiency index, MEI \geq 0.70 Net weight: 117 kg Gross weight: 140 kg Shipping volume: 0.309 m³ Country of origin: GB Custom tariff no.: 84137075</p>

On request CRN 64-2-2 A-F-H-E-HQQE 50 Hz

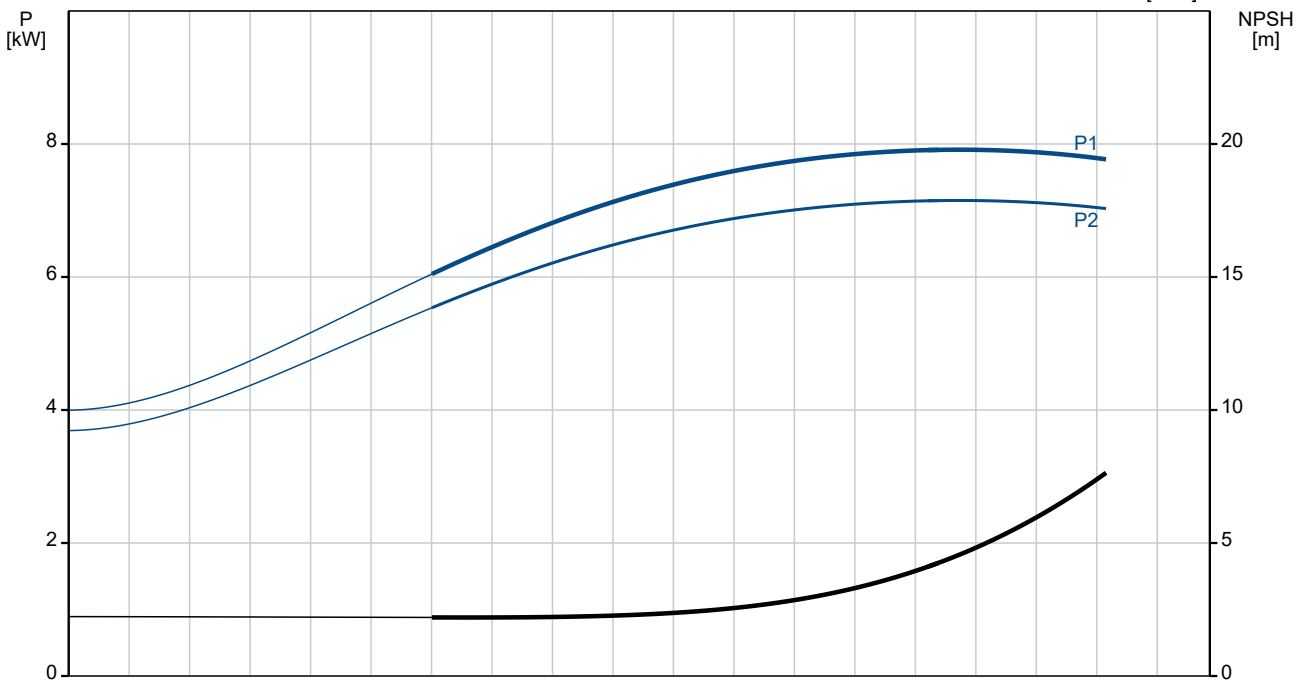
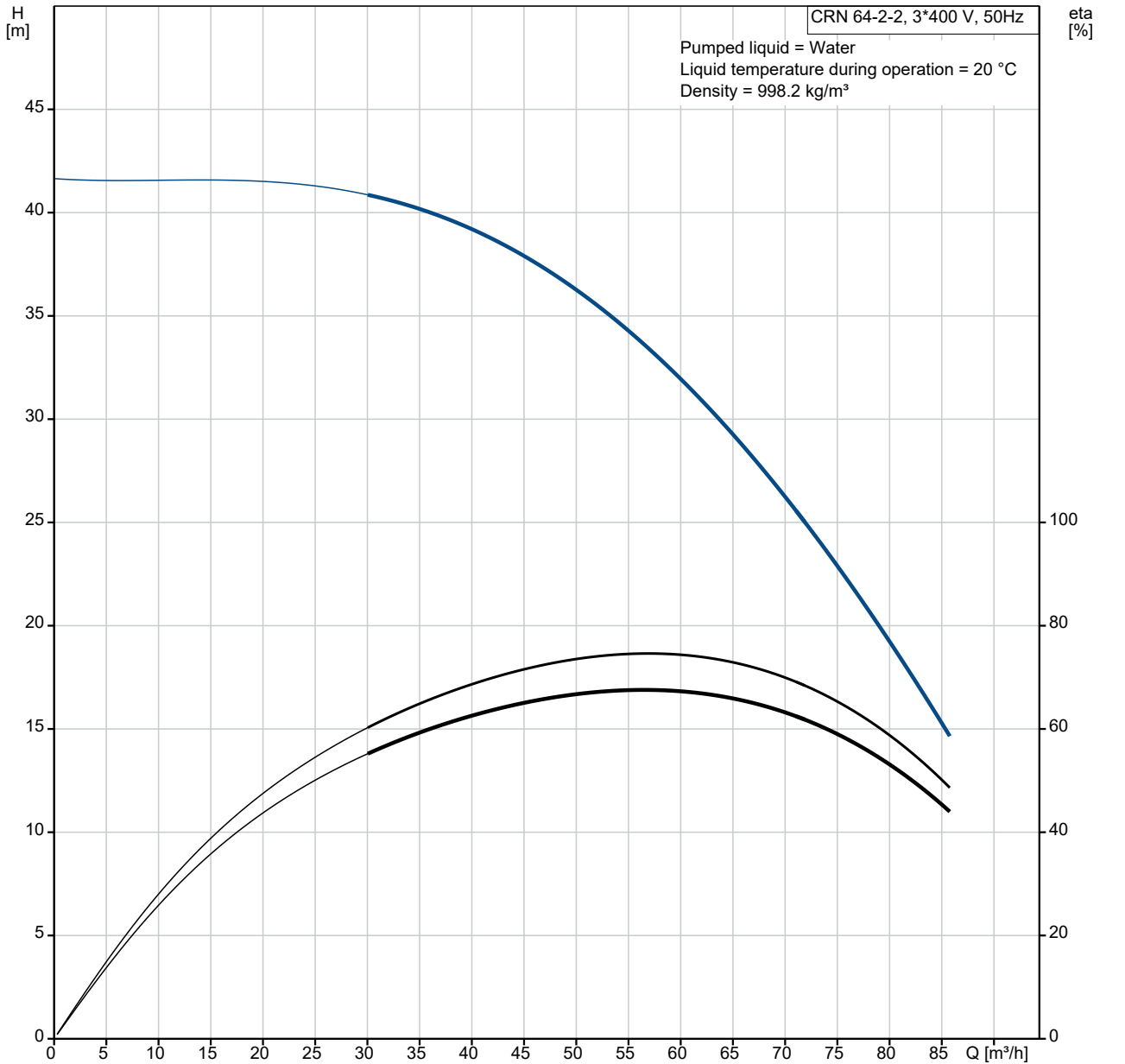

Description	Value
General information:	
Product name:	CRN 64-2-2 A-F-H-E-HQQE
Product No:	On request
EAN number:	On request
Technical:	
Pump speed on which pump data are based:	2919 rpm
Rated flow:	64 m ³ /h
Rated head:	29.2 m
Maximum head:	40.8 m
Stages:	2
Impellers:	2
Number of reduced-diameter impellers:	2
Low NPSH:	N
Pump orientation:	Vertical
Shaft seal arrangement:	Single
Code for shaft seal:	HQQE
Approvals:	CE,EAC,UKCA,SEPRO
Approvals for drinking water:	WRAS,ACS
Curve tolerance:	ISO9906:2012 3B
Pump version:	A
Model:	B
Materials:	
Base:	Stainless steel
Base:	EN 1.4408
Base:	AISI 316
Impeller:	Stainless steel
Impeller:	EN 1.4401
Impeller:	AISI 316
Material code:	H
Code for rubber:	E
Bearing:	SIC
Support bearing:	Graflon
Installation:	
t max amb:	60 °C
Maximum operating pressure:	16 bar
Max pressure at stated temp:	16 bar / 120 °C
Max pressure at stated temp:	16 bar / -40 °C
Type of connection:	DIN
Size of inlet connection:	DN 100
Size of outlet connection:	DN 100
Pressure rating for connection:	PN 16
Flange size for motor:	FF265
Connect code:	F
Liquid:	
Pumped liquid:	Water
Liquid temperature range:	-40 .. 120 °C
Selected liquid temperature:	20 °C
Density:	998.2 kg/m ³
Electrical data:	
Motor standard:	IEC
Motor type:	132SB
IE Efficiency class:	IE3
Rated power - P2:	7.5 kW
Power (P2) required by pump:	7.5 kW
Mains frequency:	50 Hz
Rated voltage:	3 x 380-415D/660-690Y V
Rated current:	14,4-14,0/8,30-8,10 A
Starting current:	780-910 %
Cos phi - power factor:	0.88-0.82
Rated speed:	2910-2920 rpm
Efficiency:	IE3 90,1%
Motor efficiency at full load:	90.1-90.4 %

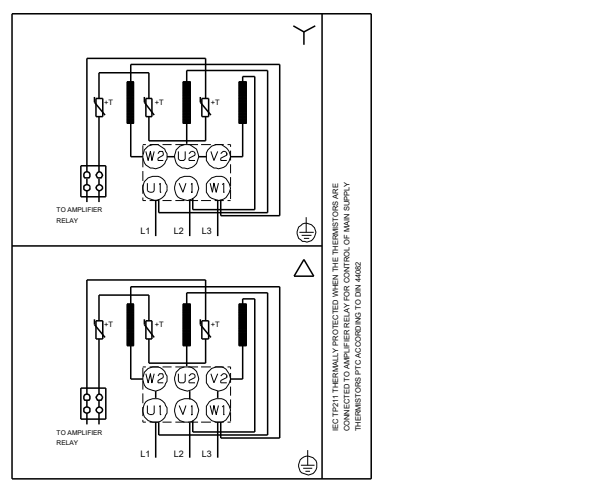
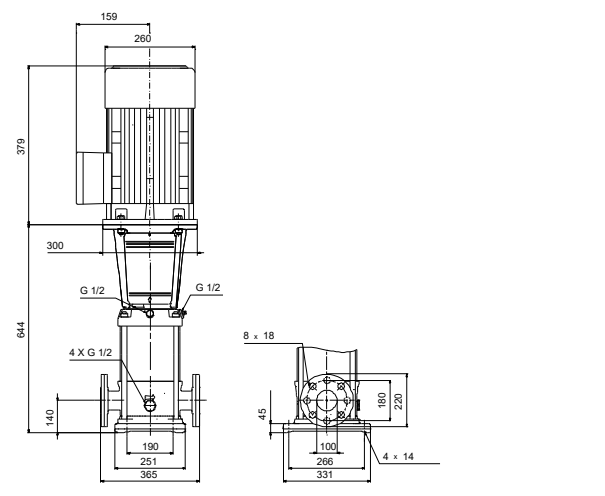
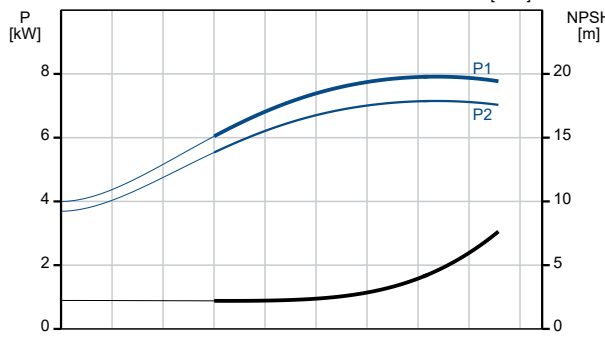
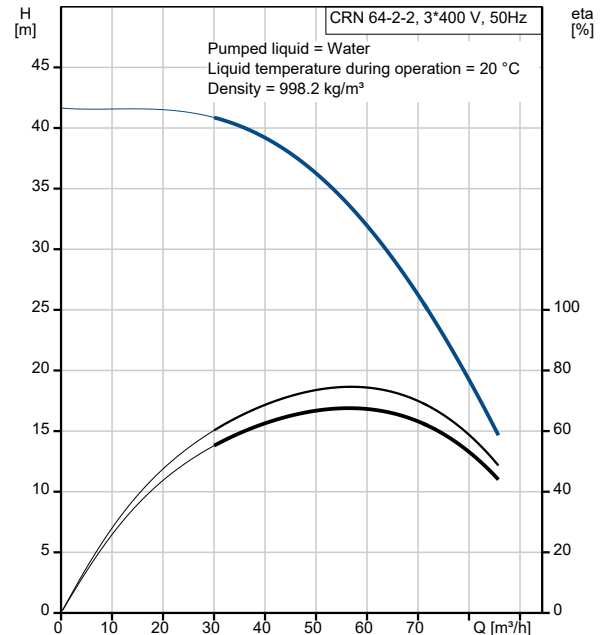

Description	Value
Motor efficiency at 3/4 load:	90.8 %
Motor efficiency at 1/2 load:	90.8 %
Number of poles:	2
Enclosure class (IEC 34-5):	55 Dust/Jetting
Insulation class (IEC 85):	F
Built-in motor protection:	PTC
Motor No:	85U17522
Controls:	
Frequency converter:	NONE
Others:	
Minimum efficiency index, MEI ≥:	0.70
Net weight:	117 kg
Gross weight:	140 kg
Shipping volume:	0.309 m ³
Sales region:	Great Britain
Country of origin:	GB
Custom tariff no.:	84137075

On request CRN 64-2-2 A-F-H-E-HQQE 50 Hz



IEC TP211 THERMALLY PROTECTED WHEN THE THERMISTORS ARE
 CONNECTED TO AMPLIFIER RELAY FOR CONTROL OF MAIN SUPPLY
 THERMISTORS PTC ACCORDING TO DIN 44082

Note! All units are in [mm] unless others are stated.

