

Qty. Description

1 RPI--0-6.0b/1/ F/M2.00-X/EG6/--/---/SC-1



Note! Product picture may differ from actual product

Product No.: [97748942](#)

The transmitter is made of 1.4404 stainless steel.

Liquid:

Liquid temperature range: -30 .. 120 °C

Technical:

Approvals: CCSAUS, EAC

Approvals for drinking water: AS4020, WRAS, ACS, NSF 61

Pressure differential functionality = Yes/No: N

Pressure relative functionality (Yes/No): Y

Flow functionality (Yes/No): N

Temperature functionality (Yes/No): Y

Minimum measuring pressure: 0 bar

Maximum measuring pressure: 6 bar

Minimum measuring temperature: 0 °C

Maximum measuring temperature: 100 °C

Installation:

Range of ambient temperature: -25 .. 60 °C

Electrical data:

Enclosure class (IEC 34-5): IP67

Length of cable: 2 m

Minimum rated voltage dc: 16.60 V

Maximum rated voltage dc: 30.00 V

Others:

Danish VVS No.: 475270260

Finnish LVI No.: 4534514

Description	Value
General information:	
Product name:	RPI/--0-6.0b/1/ F/M2.00-X/EG6/--/---/SC-1
Product No:	97748942
EAN number:	5710623704937
Technical:	
Approvals:	CCSAUS, EAC
Approvals for drinking water:	AS4020, WRAS, ACS, NSF 61
Pressure differential functionality = Yes/No:	N
Pressure relative functionality (Yes/No):	Y
Flow functionality (Yes/No):	N
Temperature functionality (Yes/No):	Y
Minimum measuring pressure:	0 bar
Maximum measuring pressure:	6 bar
Minimum measuring temperature:	0 °C
Maximum measuring temperature:	100 °C
Installation:	
Range of ambient temperature:	-25 .. 60 °C
Liquid:	
Liquid temperature range:	-30 .. 120 °C
Electrical data:	
Enclosure class (IEC 34-5):	IP67
Length of cable:	2 m
Minimum rated voltage dc:	16.60 V
Maximum rated voltage dc:	30.00 V
Others:	
Danish VVS No.:	475270260
Finnish LVI No.:	4534514

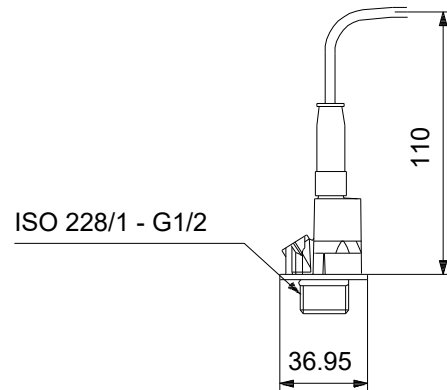

97748942 RPI/--0-6.0b/1/ F/M2.00-X/EG6/--/---/SC-1

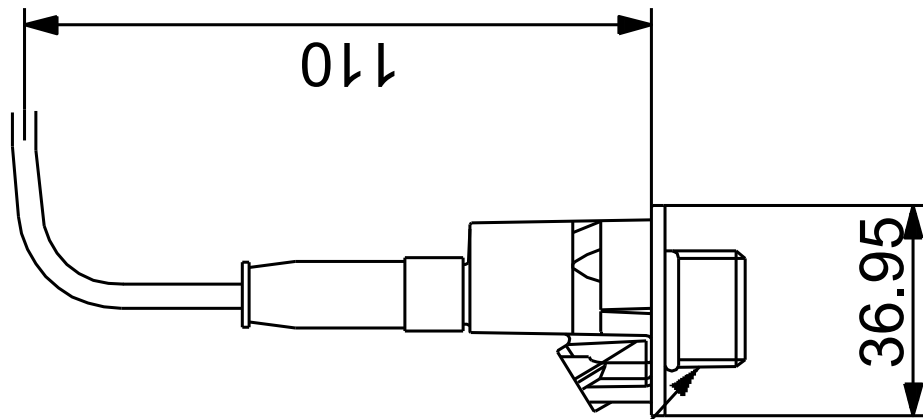

ISO 228/1 - G1/2

Note! All units are in [mm] unless others are stated.
Disclaimer: This simplified dimensional drawing does not show all details.

