

Qty.	Description
------	-------------

1	UP 20-15 N 150
---	----------------



Note! Product picture may differ from actual product

Product No.: On request

The pump is of the canned rotor type, i.e. pump and motor form an integral unit without shaft seal and with only two gaskets for sealing. The bearings are lubricated by the pumped liquid.

The pump is characterized by:

- * Ceramic shaft and radial bearings.
- * Carbon axial bearing.
- * Stainless steel rotor can and bearing plate.
- * Corrosion-resistant impeller, Composite, PES/PP.
- * Stainless steel pump housing.

The motor is a 1-phase motor.

No additional motor protection is required.

Liquid:

Pumped liquid:	Water
Liquid temperature range:	2 .. 110 °C
Selected liquid temperature:	60 °C
Density:	983.2 kg/m ³

Technical:

TF class:	95
Approvals on nameplate:	CE,WEEE,UKCA

Materials:

Pump housing:	Stainless steel DIN W.-Nr. 1.4301 AISI 304
Impeller:	Composite, PES/PP

Installation:

Amb. max at 80 dgr C liquid:	80 °C
Maximum operating pressure:	10 bar
Pipe connection:	G 1 1/4
Pressure rating:	PN 10
Port-to-port length:	150 mm

Electrical data:

Max. power input:	65 W
Mains frequency:	50 Hz
Rated voltage:	1 x 230 V
Current in speed 3:	0.28 A
Capacitor size - run:	2 µF
Enclosure class (IEC 34-5):	IP44
Insulation class (IEC 85):	F



Company name: Pump Sales Direct

Created by:

Phone: 08000086405

Email: customerservices@pumpsalesdirect.co.uk

Date: 01/08/2022

Qty.	Description
------	-------------

1	Others: Net weight: 2.1 kg Gross weight: 2.3 kg Shipping volume: 0.004 m ³ Country of origin: RS Custom tariff no.: 85030099
---	--

On request UP 20-15 N 150 50 Hz

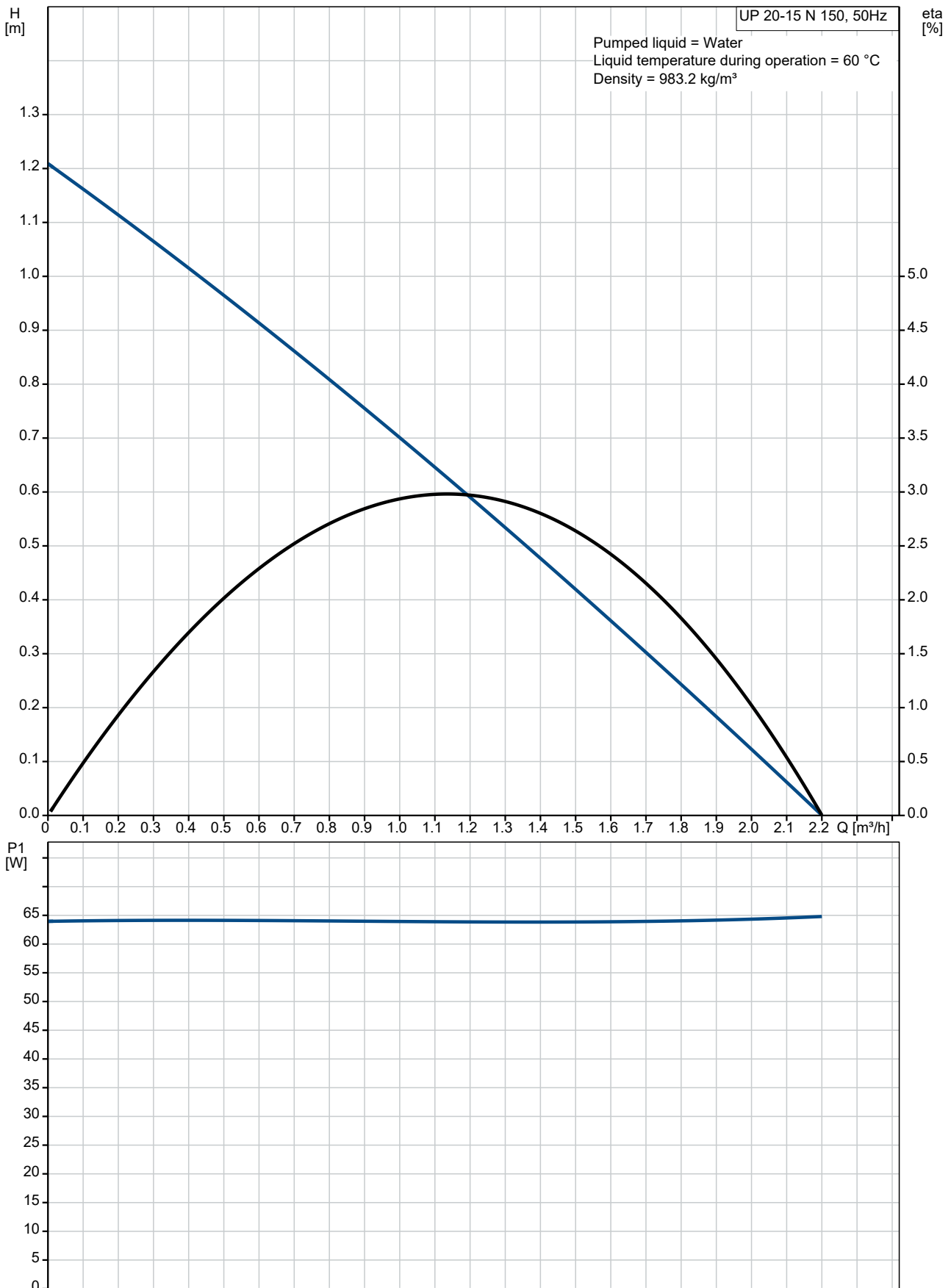

Description	Value
General information:	
Product name:	UP 20-15 N 150
Product No:	On request
EAN number:	On request
Technical:	
Speed no:	1
Head max:	15 dm
TF class:	95
Approvals on nameplate:	CE, WEEE, UKCA
Materials:	
Pump housing:	Stainless steel
Pump housing:	DIN W.-Nr. 1.4301
Pump housing:	AISI 304
Impeller:	Composite, PES/PP
Installation:	
Amb. max at 80 dgr C liquid:	80 °C
Maximum operating pressure:	10 bar
Pipe connection:	G 1 1/4
Pressure rating:	PN 10
Port-to-port length:	150 mm
Liquid:	
Pumped liquid:	Water
Liquid temperature range:	2 .. 110 °C
Selected liquid temperature:	60 °C
Density:	983.2 kg/m ³
Electrical data:	
Max. power input:	65 W
Mains frequency:	50 Hz
Rated voltage:	1 x 230 V
Current in speed 3:	0.28 A
Capacitor size - run:	2 µF
Enclosure class (IEC 34-5):	IP44
Insulation class (IEC 85):	F
Built-in motor protection:	NONE
Thermal protec:	Impedance protected
Controls:	
Pos term box:	9H
Others:	
Net weight:	2.1 kg
Gross weight:	2.3 kg
Shipping volume:	0.004 m ³
Country code:	GB
Country of origin:	RS
Custom tariff no.:	85030099

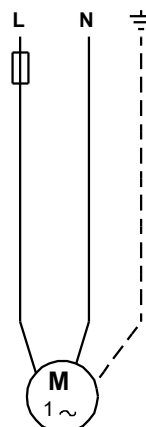
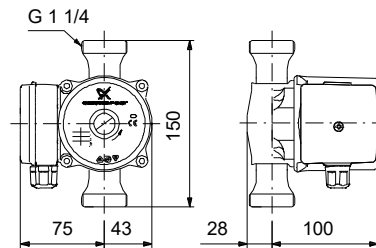
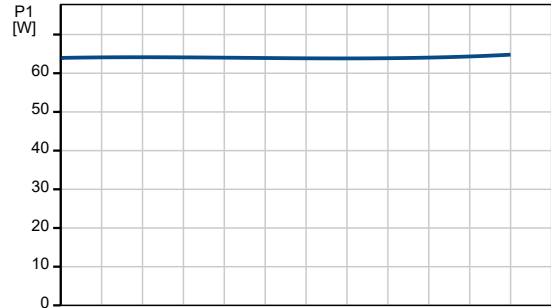
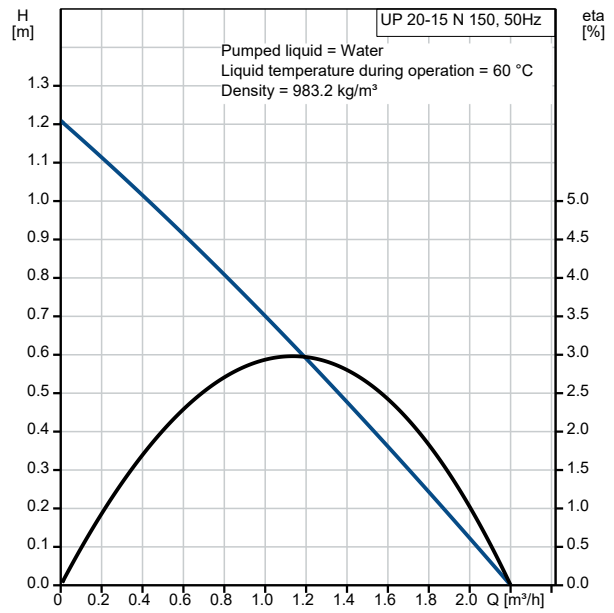

On request UP 20-15 N 150 50 Hz

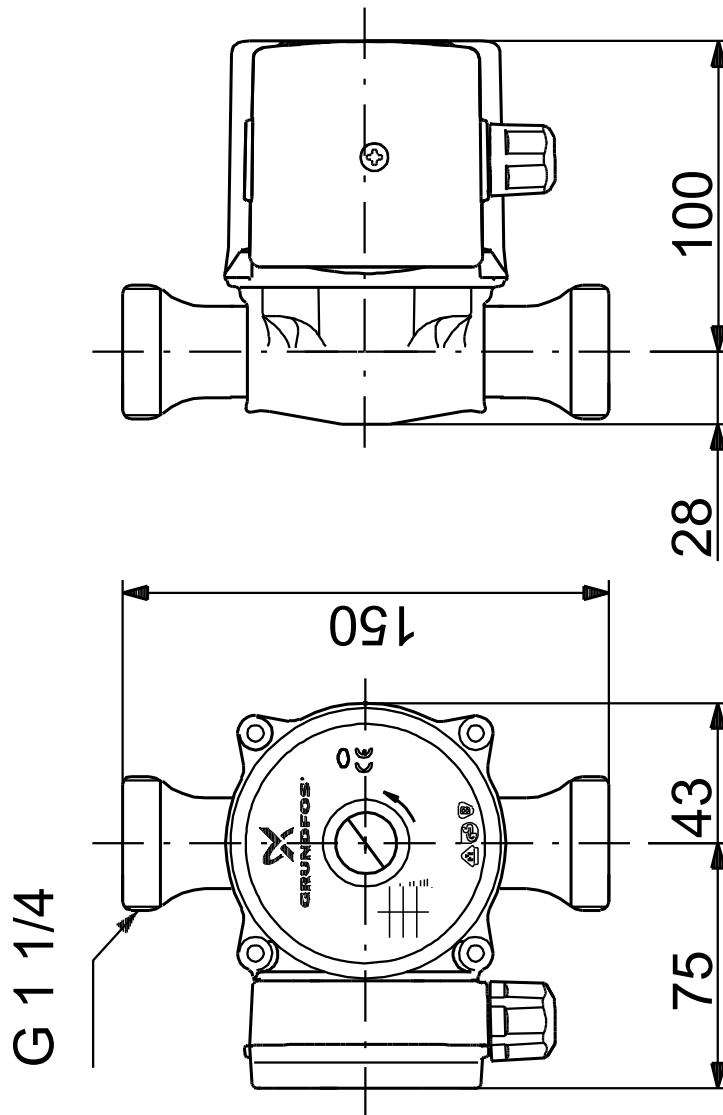

Note! All units are in [mm] unless others are stated.
Disclaimer: This simplified dimensional drawing does not show all details.

On request UP 20-15 N 150 50 Hz

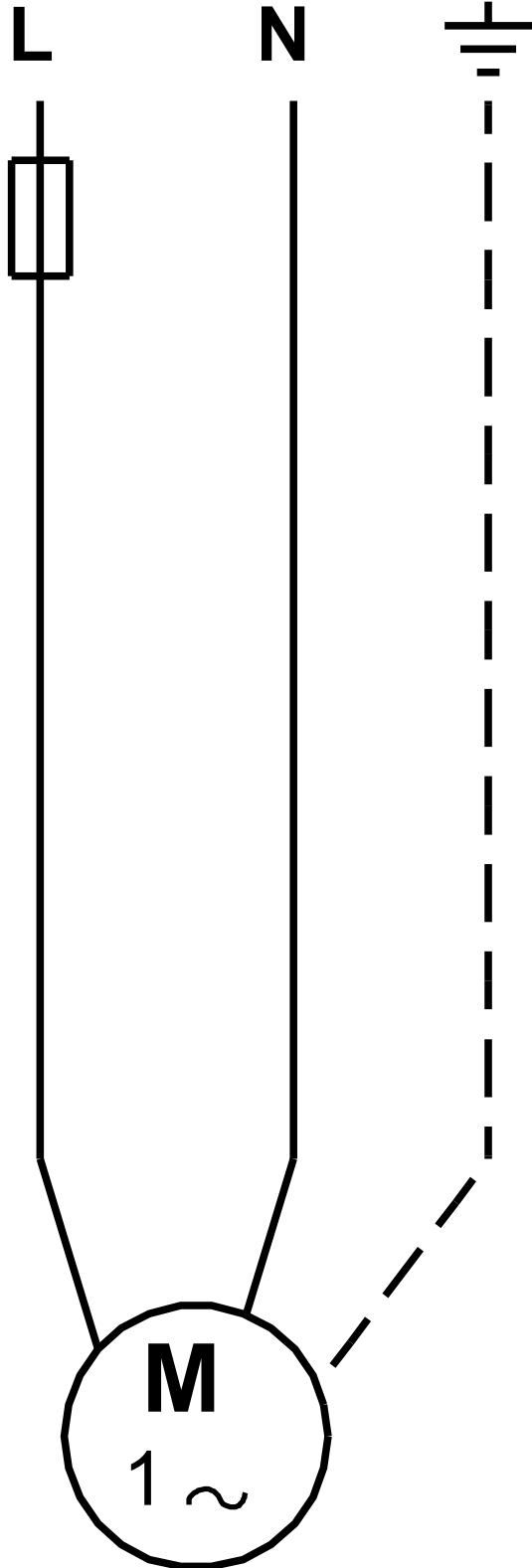

Note! All units are in [mm] unless others are stated.



Company name: Pump Sales Direct

Created by:

Phone: 08000086405

Email: customerservices@pumpsalesdirect.co.uk

Date: 01/08/2022

Order Data:

Position	Your pos.	Product name	Amount	Product No	Total
		UP 20-15 N 150	1	On request	Price on request