

Qty.	Description
------	-------------

1	Insulation cooling
---	--------------------



Note! Product picture may differ from actual product

Product No.: [98063289](#)

The accessory is for single-head MAGNA pumps used in applications with ice build-up.

The accessory set consists of two polyurethane (PUR) shells and metal clamps to ensure tight assembly.

The dimensions of the insulating shells for air-conditioning and cooling systems differ from those of the insulating shells for heating systems. You can use the insulating shells for both stainless-steel and cast-iron pumps.

Description	Value
General information:	
Product name:	Insulation cooling
Product No:	98063289
EAN number:	5710628349249
Materials:	
Material:	Polyethylene
Others:	
Net weight:	0.42 kg
Gross weight:	0.66 kg
Shipping volume:	0.018 m ³
Fits to following products:	MAGNA3
Fits to variant:	50-40/60/80 F
Application type:	cooling
Danish VVS No.:	380969812
Finnish LVI No.:	4616531
Country of origin:	DE
Custom tariff no.:	39211100

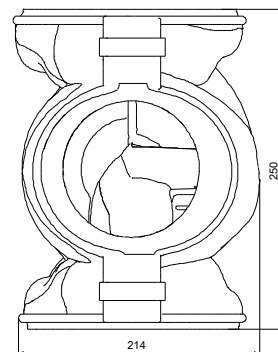
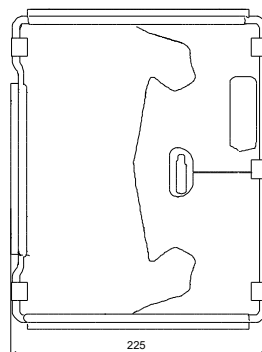

98063289 Insulation cooling 50 Hz

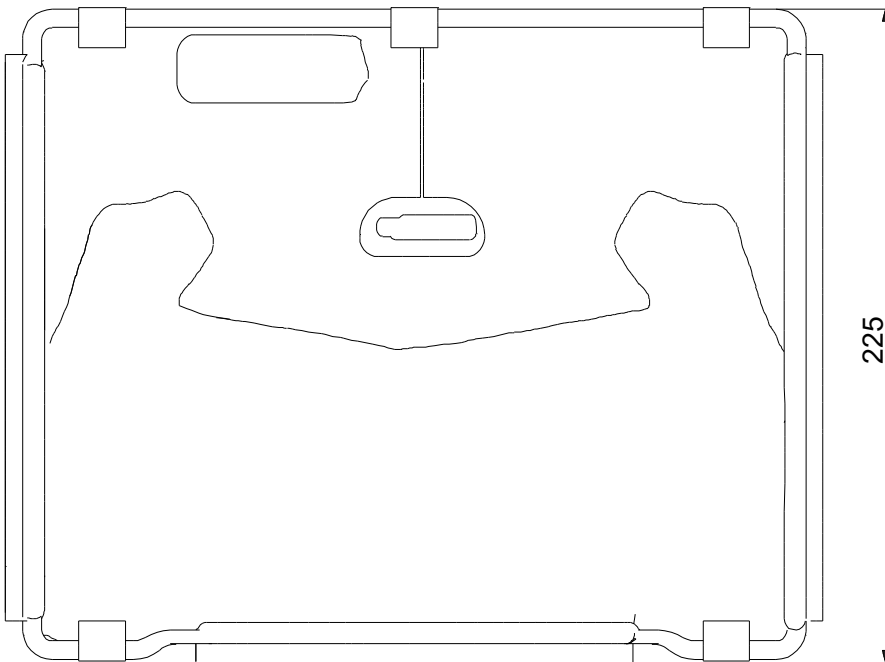
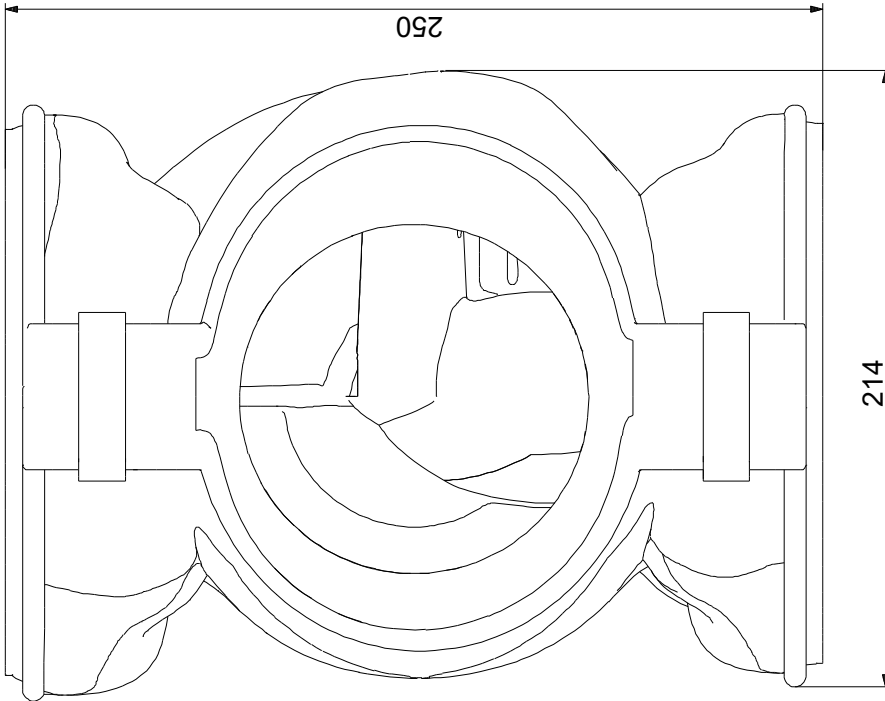

Note! All units are in [mm] unless others are stated.
Disclaimer: This simplified dimensional drawing does not show all details.



Company name: Pump Sales Direct

Created by:

Phone:

Date: 24/06/2022

Order Data:

Product name: Insulation cooling

Amount: 1

Product No: 98063289

Total: Price on request
