

**Qty. Description**

1 TPE2 32-80 N-A-F-A-BQQE-CDB



Note! Product picture may differ from actual product

Product No.: [98437880](#)

Single-stage, close-coupled, volute pump with in-line suction and discharge ports of identical diameter. The pump is of the top-pull-out design, i.e. the power head (motor, pump head and impeller) can be removed for maintenance or service while the pump housing remains in the pipework.

The shaft seal is according to EN 12756. Pipework connection is via PN 6/10 DIN flanges (EN 1092-2 and ISO 7005-2).

The pump is fitted with a fan-cooled, permanent-magnet synchronous motor. The motor efficiency is classified as IE5 in accordance with IEC 60034-30-2.

The product's minimum efficiency index (MEI) is greater or equal to 0.70. This is by the Commission Regulation (EU) considered as an indicative benchmark for best-performing water pump available on the market as from 1 January 2013.

An operating panel on the motor terminal box enables setting of required setpoint as well as setting of pump to "Min." or "Max." operation or to "Stop". The Grundfos Eye indicator on the operating panel provides visual indication of pump status:

- "Power on": Motor is running (rotating green indicator lights) or not running (permanently green indicator lights)
- "Warning": Motor is still running (rotating yellow indicator lights) or has stopped (permanently yellow indicator lights)
- "Alarm": Motor has stopped (flashing red indicator lights).

Communication with the pump is possible by means of Grundfos GO Remote (accessory). The remote control enables further settings as well as reading out of a number of parameters such as "Actual value", "Speed", "Power input" and total "Power consumption".

Cast-iron parts have an epoxy-based coating made in a cathodic electro-deposition (CED) process. CED is a high-quality dip-painting process where an electrical field around the products ensures deposition of paint particles as a thin, well-controlled layer on the surface.

## Pump

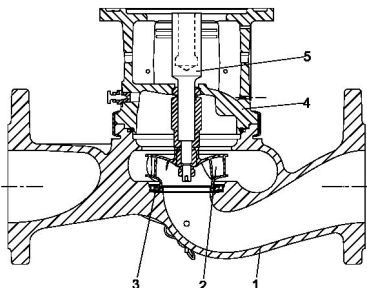

- 1: Pump housing
- 2: Impeller
- 3: Neck ring
- 4: Pump head/motor stool
- 5: Stub shaft

The pump housing is provided with a replaceable stainless steel/PTFE neck ring to reduce the amount of liquid running from the discharge side of the impeller to the suction side.

The impeller is secured to the shaft with a nut.

Qty.	Description
1	<p>The pump is fitted with an unbalanced rubber bellows seal with torque transmission across the spring and around the bellows. Due to the bellows, the seal does not wear the shaft, and the axial movement is not prevented by deposits on the shaft.</p> <p>Seal faces:</p> <ul style="list-style-type: none"> <li>• Rotating seal ring material: silicon carbide (SiC)</li> <li>• Stationary seat material: silicon carbide (SiC)</li> </ul> <p>This material pairing is used where higher corrosion resistance is required. The high hardness of this material pairing offers good resistance against abrasive particles.</p> <p>Secondary seal material: EPDM (ethylene-propylene rubber)            EPDM has excellent resistance to hot water. EPDM is not suitable for mineral oils.</p> <p>The motor stool forms connection between the pump housing and the motor, and is equipped with a manual air vent screw for venting of the pump housing and the shaft seal chamber. The sealing between motor stool and pump housing is an O-ring.</p> <p>The central part of the motor stool is provided with guards for protection against the shaft and coupling. The pump shaft is fastened directly on the motor shaft with key and set screws.</p> <p><b>Motor</b></p> <p>The motor is a totally enclosed, fan-cooled motor with principal dimensions to IEC and DIN standards. Electrical tolerances comply with IEC 60034.</p> <p>The motor efficiency is classified as IE5 in accordance with IEC 60034-30-2.</p> <p>The motor requires no external motor protection. The motor control unit incorporates protection against slow- and quick-rising temperatures, e.g. constant overload and stalled conditions.</p> <p><b>Further product details</b></p> <p>Cast-iron parts have an epoxy-based coating made in a cathodic electro-deposition (CED) process. CED is a high-quality dip-painting process where an electrical field around the products ensures deposition of paint particles as a thin, well-controlled layer on the surface.</p> <p><b>Technical data</b></p> <p>Controls:</p> <p>Frequency converter: Built-in</p> <p>Liquid:</p> <p>Pumped liquid: Water</p> <p>Liquid temperature range: -25 .. 120 °C</p> <p>Selected liquid temperature: 20 °C</p> <p>Density: 998.2 kg/m<sup>3</sup></p> <p>Technical:</p> <p>Pump speed on which pump data are based: 3450 rpm</p> <p>Rated flow: 10.7 m<sup>3</sup>/h</p> <p>Rated head: 5.9 m</p> <p>Actual impeller diameter: 62 mm</p> <p>Code for shaft seal: BQQE</p> <p>Curve tolerance: ISO9906:2012 3B2</p> <p>Materials:</p> <p>Pump housing: Cast iron            EN-GJL-250            ASTM class 35</p> <p>Impeller: Composite            PES+30% GF</p> <p>Installation:</p> <p>Range of ambient temperature: -20 .. 50 °C</p> <p>Maximum operating pressure: 10 bar</p> <p>Max pressure at stated temp: 10 bar / 120 °C</p>

Qty.	Description
------	-------------

1	Type of connection: DIN
	Size of connection: DN 32
	Pressure rating for connection: PN 6/10
	Port-to-port length: 220 mm
	Flange size for motor: 56C
	Electrical data:
	Motor type: 71A
	IE Efficiency class: IE5
	Rated power - P2: 0.25 kW
	Mains frequency: 50 / 60 Hz
	Rated voltage: 3 x 380-500 V
	Rated current: 0.90-0.75 A
	Cos phi - power factor: 0.58-0.50
	Rated speed: 360-4000 rpm
	Efficiency: 81.2%
	Motor efficiency at full load: 81.2 %
	Enclosure class (IEC 34-5): IP55
	Insulation class (IEC 85): F
	Motor No: 99138013
	Others:
	Minimum efficiency index, MEI $\geq$ : 0.70
	Net weight: 23.6 kg
	Gross weight: 31.1 kg
	Shipping volume: 0.104 m <sup>3</sup>
	Finnish LVI No.: 4616282
	Country of origin: HU
	Custom tariff no.: 84137051

## 98437880 TPE2 32-80 N-A-F-A-BQQE-CDB

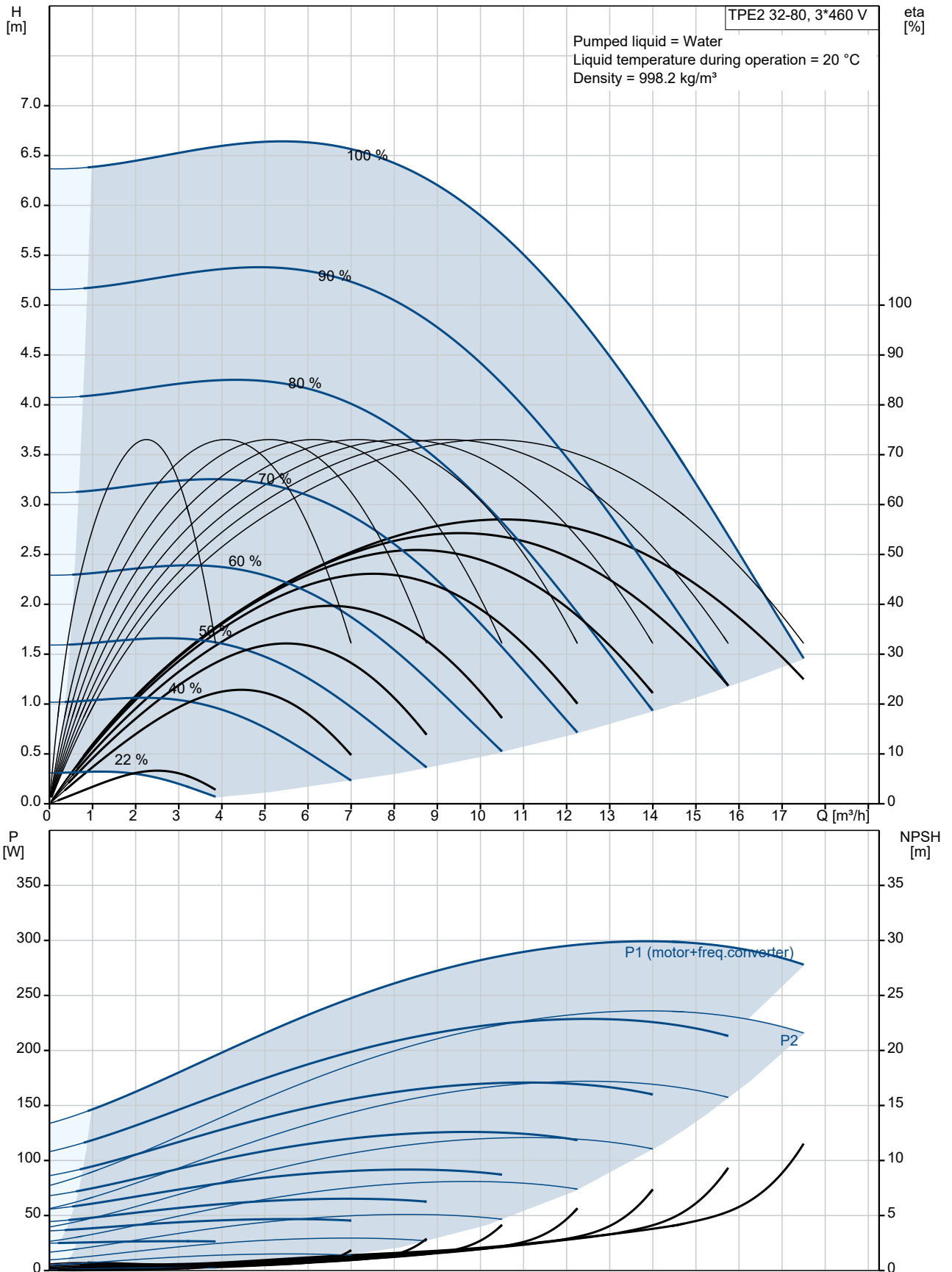

Description	Value
<b>General information:</b>	
Product name:	TPE2 32-80 N-A-F-A-BQQE-CDB
Product No:	98437880
EAN number:	5711495010768
<b>Technical:</b>	
Pump speed on which pump data are based:	3450 rpm
Rated flow:	10.7 m <sup>3</sup> /h
Rated head:	5.9 m
Maximum head:	80 dm
Actual impeller diameter:	62 mm
Code for shaft seal:	BQQE
Curve tolerance:	ISO9906:2012 3B2
Pump version:	A
<b>Materials:</b>	
Pump housing:	Cast iron
Pump housing:	EN-GJL-250
Pump housing:	ASTM class 35
Impeller:	Composite
Impeller:	PES+30% GF
Material code:	A
<b>Installation:</b>	
Range of ambient temperature:	-20 .. 50 °C
Maximum operating pressure:	10 bar
Max pressure at stated temp:	10 bar / 120 °C
Type of connection:	DIN
Size of connection:	DN 32
Pressure rating for connection:	PN 6/10
Port-to-port length:	220 mm
Flange size for motor:	56C
Connect code:	F
<b>Liquid:</b>	
Pumped liquid:	Water
Liquid temperature range:	-25 .. 120 °C
Selected liquid temperature:	20 °C
Density:	998.2 kg/m <sup>3</sup>
<b>Electrical data:</b>	
Motor type:	71A
IE Efficiency class:	IE5
Rated power - P2:	0.25 kW
Mains frequency:	50 / 60 Hz
Rated voltage:	3 x 380-500 V
Rated current:	0.90-0.75 A
Cos phi - power factor:	0.58-0.50
Rated speed:	360-4000 rpm
Efficiency:	81.2%
Motor efficiency at full load:	81.2 %
Enclosure class (IEC 34-5):	IP55
Insulation class (IEC 85):	F
Built-in motor protection:	ELEC
Motor No:	99138013
<b>Controls:</b>	
Control panel:	HMI200 - Standard
Function Module:	FM300 - Advanced
Frequency converter:	Built-in
<b>Others:</b>	
Minimum efficiency index, MEI ≥:	0.70
Net weight:	23.6 kg

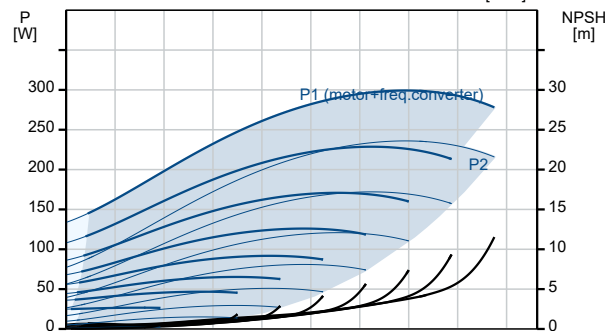
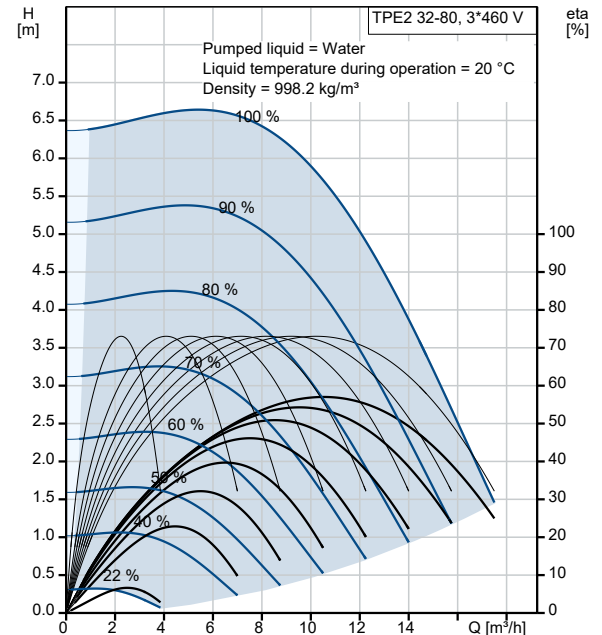



Company name:

Created by:

Phone:

Date:

08/08/2022

Description	Value
Gross weight:	31.1 kg
Shipping volume:	0.104 m <sup>3</sup>
Config. file no:	98819246
Finnish LVI No.:	4616282
Country of origin:	HU
Custom tariff no.:	84137051

## 98437880 TPE2 32-80 N-A-F-A-BQQE-CDB

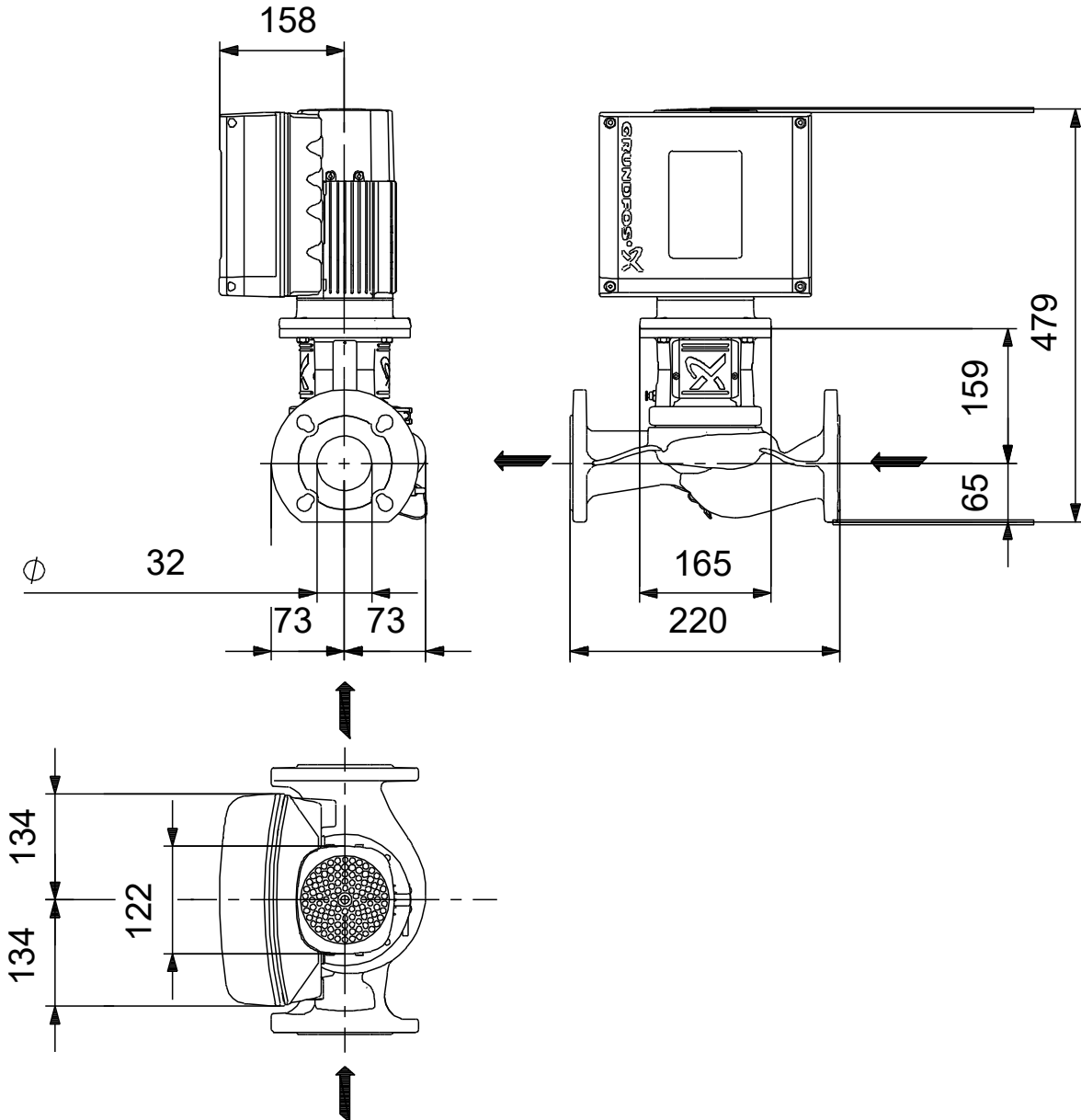

Note! All units are in [mm] unless others are stated.  
Disclaimer: This simplified dimensional drawing does not show all details.

## 98437880 TPE2 32-80 N-A-F-A-BQQE-CDB

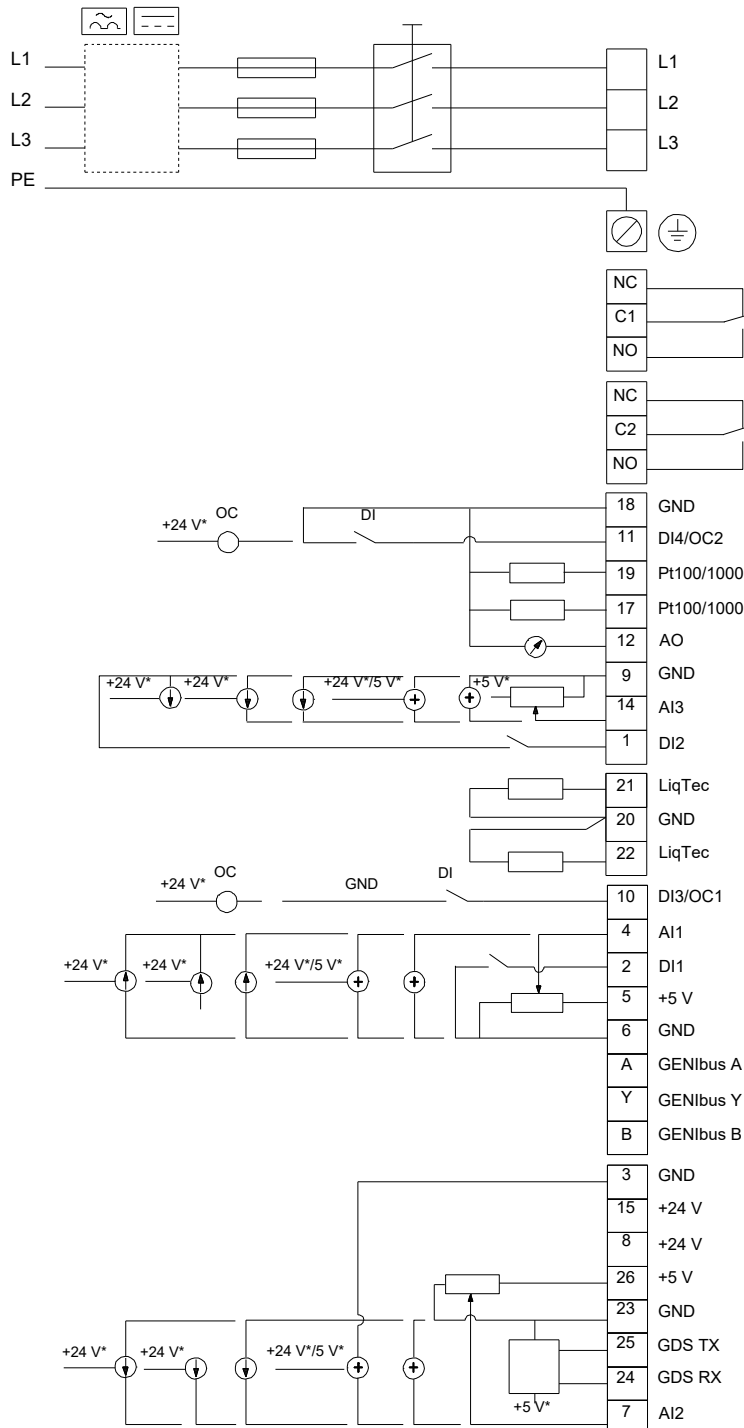

Note! All units are in [mm] unless others are stated.