

Qty.	Description
1	MTR 1-17/17 A-W-A-HUUV
	
	Product No.: On request
	Multistage, immersible, self-priming, centrifugal pump for vertical installation in tanks etc. The pump head and base are in cast iron – all other wetted parts are in stainless steel. The pump has the following characteristics:
	<ul style="list-style-type: none"> • Dimensions according to DIN 5440. • Impellers, intermediate chambers and spline shaft are made of Stainless steel. • Mechanical shaft seal according to EN 12756. • Power transmission via sintered metal split coupling.
	A cartridge shaft seal ensures high reliability, safe handling, and easy access and service. The pump is fitted with a 3-phase, fan-cooled asynchronous motor.
	Controls:
	Frequency converter: NONE
	Liquid:
	Pumped liquid: Water
	Liquid temperature range: -10 .. 90 °C
	Selected liquid temperature: 20 °C
	Density: 998.2 kg/m ³
	Technical:
	Pump speed on which pump data are based: 2853 rpm
	Rated flow: 30 l/min
	Rated head: 79.3 m
	Chambers: 17
	Drainage back to tank: N
	Pump orientation: Vertical
	Code for shaft seal: HUUV
	Approvals: CE,EAC
	Curve tolerance: ISO9906:2012 3B
	Materials:
	Pump head: Cast iron EN 1561 EN-GJL-200 ASTM A48-25B Impeller: Stainless steel EN 1.4301 AISI 304
	Installation:
	t max amb: 60 °C
	Maximum operating pressure: 25 bar
	Max pressure at stated temp: 25 bar / 90 °C
	Type of connection: G internal thread
	Size of outlet connection: 1 1/4 inch
	Immersion depth: 430 mm
	Flange size for motor: FT100
	Electrical data:
	Motor standard: IEC
	Motor type: 80C
	IE Efficiency class: IE3
	Rated power - P2: 1.1 kW

Qty.	Description																																																
1	<table> <tr> <td>Mains frequency:</td> <td>50 Hz</td> </tr> <tr> <td>Suitable for 50/60 Hz:</td> <td>N</td> </tr> <tr> <td>Rated voltage:</td> <td>3 x 220-240D/380-415Y V</td> </tr> <tr> <td>Rated current:</td> <td>4.35/2.50 A</td> </tr> <tr> <td>Starting current:</td> <td>450-500 %</td> </tr> <tr> <td>Cos phi - power factor:</td> <td>0.83-0.76</td> </tr> <tr> <td>Rated speed:</td> <td>2840-2870 rpm</td> </tr> <tr> <td>Efficiency:</td> <td>IE3 82,7%</td> </tr> <tr> <td>Motor efficiency at full load:</td> <td>82.7 %</td> </tr> <tr> <td>Motor efficiency at 3/4 load:</td> <td>84.6 %</td> </tr> <tr> <td>Motor efficiency at 1/2 load:</td> <td>85.4 %</td> </tr> <tr> <td>Number of poles:</td> <td>2</td> </tr> <tr> <td>Enclosure class (IEC 34-5):</td> <td>55 Dust/Jetting</td> </tr> <tr> <td>Insulation class (IEC 85):</td> <td>F</td> </tr> <tr> <td>Motor No:</td> <td>85U05105</td> </tr> <tr> <td colspan="2">Others:</td> </tr> <tr> <td>Terminal box position:</td> <td>6</td> </tr> <tr> <td>Minimum efficiency index, MEI ≥:</td> <td>0.70</td> </tr> <tr> <td>Net weight:</td> <td>17 kg</td> </tr> <tr> <td>Gross weight:</td> <td>20.6 kg</td> </tr> <tr> <td>Shipping volume:</td> <td>0.077 m³</td> </tr> <tr> <td>Danish VVS No.:</td> <td>386961017</td> </tr> <tr> <td>Country of origin:</td> <td>HU</td> </tr> <tr> <td>Custom tariff no.:</td> <td>84137075</td> </tr> </table>	Mains frequency:	50 Hz	Suitable for 50/60 Hz:	N	Rated voltage:	3 x 220-240D/380-415Y V	Rated current:	4.35/2.50 A	Starting current:	450-500 %	Cos phi - power factor:	0.83-0.76	Rated speed:	2840-2870 rpm	Efficiency:	IE3 82,7%	Motor efficiency at full load:	82.7 %	Motor efficiency at 3/4 load:	84.6 %	Motor efficiency at 1/2 load:	85.4 %	Number of poles:	2	Enclosure class (IEC 34-5):	55 Dust/Jetting	Insulation class (IEC 85):	F	Motor No:	85U05105	Others:		Terminal box position:	6	Minimum efficiency index, MEI ≥:	0.70	Net weight:	17 kg	Gross weight:	20.6 kg	Shipping volume:	0.077 m ³	Danish VVS No.:	386961017	Country of origin:	HU	Custom tariff no.:	84137075
Mains frequency:	50 Hz																																																
Suitable for 50/60 Hz:	N																																																
Rated voltage:	3 x 220-240D/380-415Y V																																																
Rated current:	4.35/2.50 A																																																
Starting current:	450-500 %																																																
Cos phi - power factor:	0.83-0.76																																																
Rated speed:	2840-2870 rpm																																																
Efficiency:	IE3 82,7%																																																
Motor efficiency at full load:	82.7 %																																																
Motor efficiency at 3/4 load:	84.6 %																																																
Motor efficiency at 1/2 load:	85.4 %																																																
Number of poles:	2																																																
Enclosure class (IEC 34-5):	55 Dust/Jetting																																																
Insulation class (IEC 85):	F																																																
Motor No:	85U05105																																																
Others:																																																	
Terminal box position:	6																																																
Minimum efficiency index, MEI ≥:	0.70																																																
Net weight:	17 kg																																																
Gross weight:	20.6 kg																																																
Shipping volume:	0.077 m ³																																																
Danish VVS No.:	386961017																																																
Country of origin:	HU																																																
Custom tariff no.:	84137075																																																

On request MTR 1-17/17 A-W-A-HUUV 50 Hz

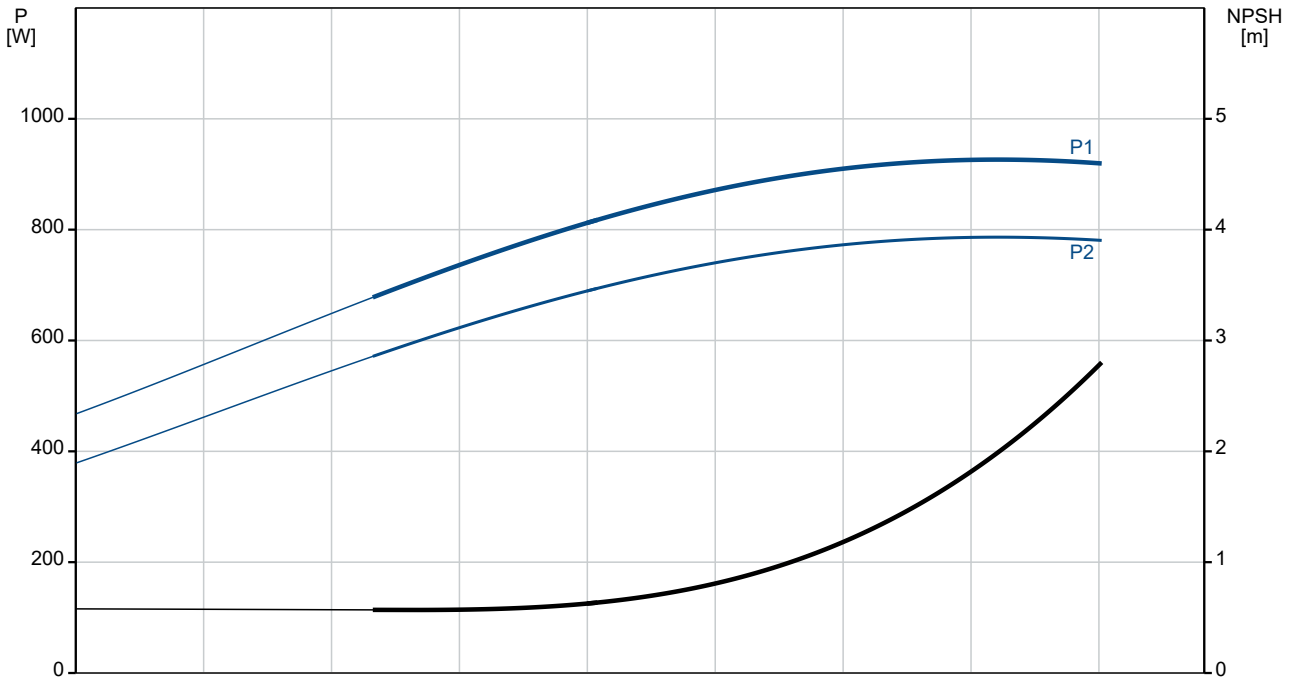
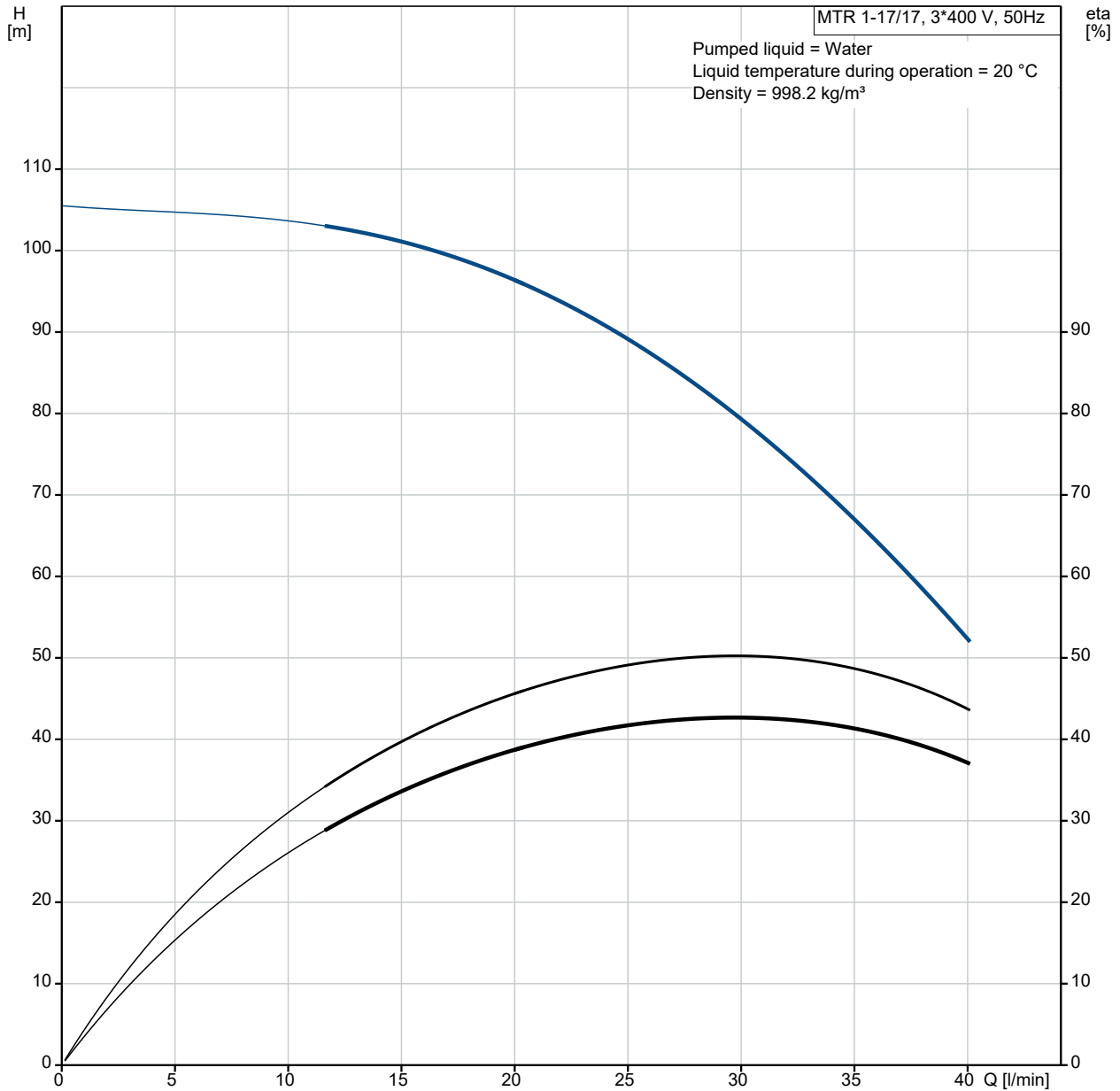

Description	Value
General information:	
Product name:	MTR 1-17/17 A-W-A-HUUV
Product No:	On request
EAN number:	On request
Technical:	
Pump speed on which pump data are based:	2853 rpm
Rated flow:	30 l/min
Rated head:	79.3 m
Chambers:	17
Impellers:	17
Number of reduced-diameter impellers:	0
Drainage back to tank:	N
Pump orientation:	Vertical
Code for shaft seal:	HUUV
Approvals:	CE,EAC
Curve tolerance:	ISO9906:2012 3B
Pump version:	A
Model:	A
Materials:	
Pump head:	Cast iron
Pump head:	EN 1561 EN-GJL-200
Pump head:	ASTM A48-25B
Impeller:	Stainless steel
Impeller:	EN 1.4301
Impeller:	AISI 304
Material code:	A
Installation:	
t max amb:	60 °C
Maximum operating pressure:	25 bar
Max pressure at stated temp:	25 bar / 90 °C
Type of connection:	G internal thread
Size of outlet connection:	1 1/4 inch
Immersion depth:	430 mm
Flange size for motor:	FT100
Connect code:	W
Liquid:	
Pumped liquid:	Water
Liquid temperature range:	-10 .. 90 °C
Selected liquid temperature:	20 °C
Density:	998.2 kg/m ³
Electrical data:	
Motor standard:	IEC
Motor type:	80C
IE Efficiency class:	IE3
Rated power - P2:	1.1 kW
Mains frequency:	50 Hz
Suitable for 50/60 Hz:	N
Rated voltage:	3 x 220-240D/380-415Y V
Rated current:	4.35/2.50 A
Starting current:	450-500 %
Cos phi - power factor:	0.83-0.76
Rated speed:	2840-2870 rpm
Efficiency:	IE3 82,7%
Motor efficiency at full load:	82.7 %
Motor efficiency at 3/4 load:	84.6 %
Motor efficiency at 1/2 load:	85.4 %
Number of poles:	2
Enclosure class (IEC 34-5):	55 Dust/Jetting
Insulation class (IEC 85):	F
Built-in motor protection:	NONE
Motor No:	85U05105
Controls:	

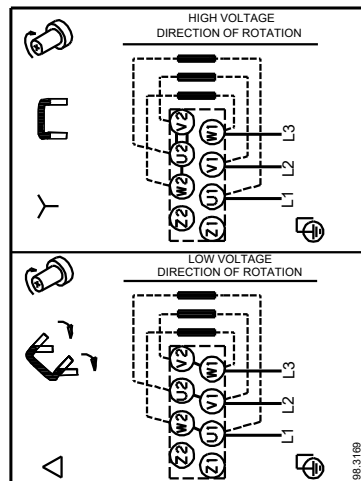
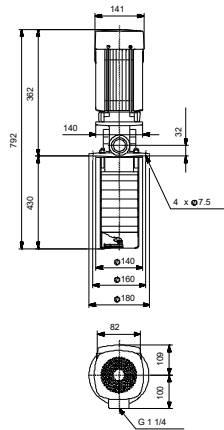
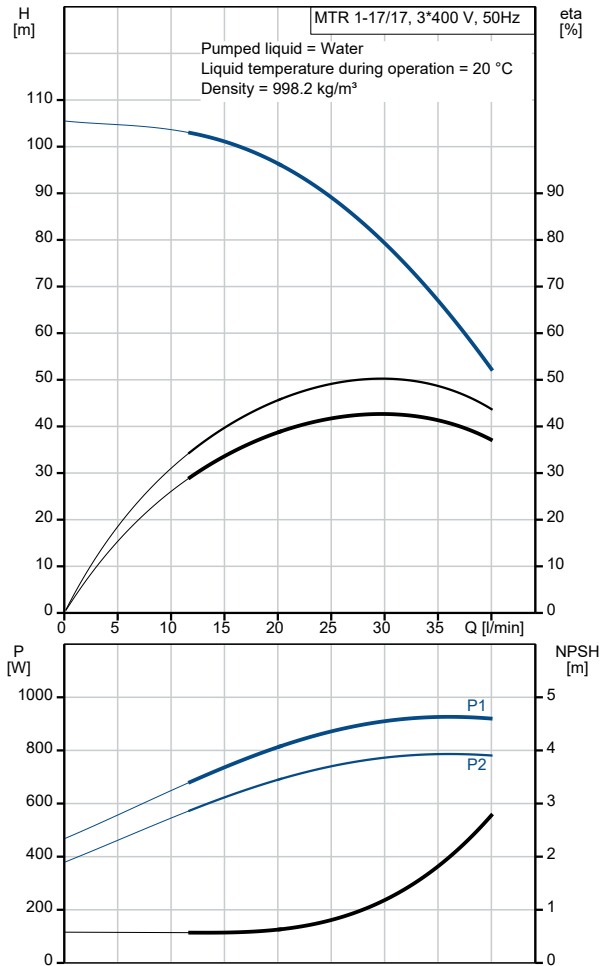

Description	Value
Frequency converter:	NONE
Others:	
Terminal box position:	6
Minimum efficiency index, MEI ≥:	0.70
Net weight:	17 kg
Gross weight:	20.6 kg
Shipping volume:	0.077 m ³
Danish VVS No.:	386961017
Country of origin:	HU
Custom tariff no.:	84137075

On request MTR 1-17/17 A-W-A-HUUV 50 Hz

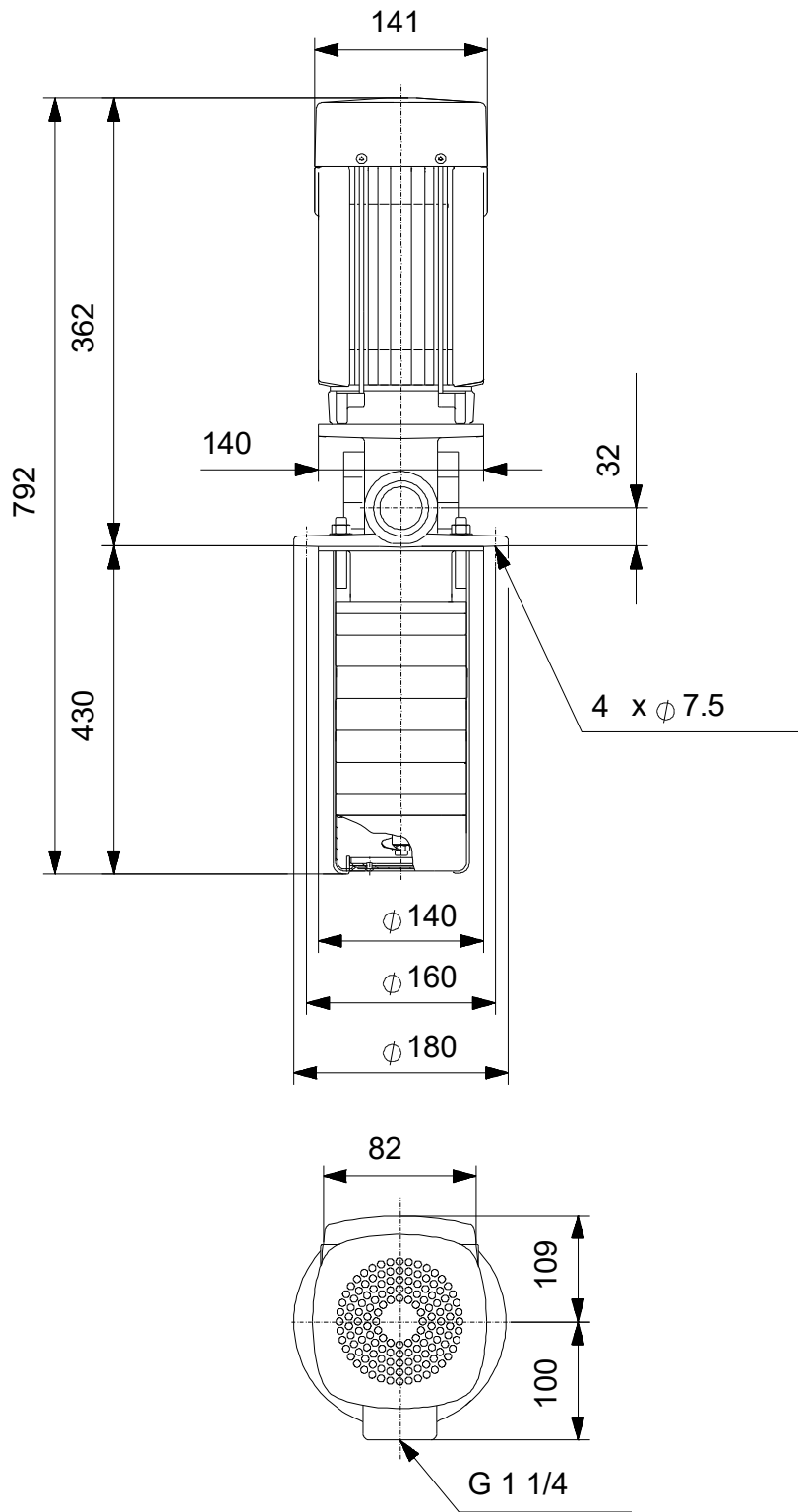

Note! All units are in [mm] unless others are stated.
Disclaimer: This simplified dimensional drawing does not show all details.

On request MTR 1-17/17 A-W-A-HUUV 50 Hz



98.3169

Note! All units are in [mm] unless others are stated.

