

**Qty. Description**

1 **MTR 3-36/36 A-W-A-HUUV**



Product No.: [98511283](#)

Multistage, immersible, self-priming, centrifugal pump for vertical installation in tanks etc. The pump head and base are in cast iron – all other wetted parts are in stainless steel.

The pump has the following characteristics TEST:

- Dimensions according to DIN 5440.
- Impellers, intermediate chambers and spline shaft are made of Stainless steel.
- Mechanical shaft seal according to EN 12756.
- Power transmission via sintered metal split coupling.

A cartridge shaft seal ensures high reliability, safe handling, and easy access and service. The pump is fitted with a 3-phase, fan-cooled asynchronous motor.

**Controls:**

Frequency converter: NONE

**Liquid:**

Pumped liquid: Water  
 Liquid temperature range: -10 .. 90 °C  
 Selected liquid temperature: 20 °C  
 Density: 998.2 kg/m<sup>3</sup>

**Technical:**

Pump speed on which pump data are based: 2902 rpm  
 Rated flow: 50 l/min  
 Rated head: 185.6 m  
 Chambers: 36  
 Drainage back to tank: N  
 Pump orientation: Vertical  
 Code for shaft seal: HUUV  
 Approvals: CE, EAC  
 Curve tolerance: ISO9906:2012 3B

**Materials:**

Pump head: Cast iron  
 EN 1561 EN-GJL-200  
 ASTM A48-25B  
 Impeller: Stainless steel  
 EN 1.4301  
 AISI 304

**Installation:**

t max amb: 60 °C  
 Maximum operating pressure: 25 bar  
 Max pressure at stated temp: 25 bar / 90 °C  
 Type of connection: G internal thread

Qty.	Description
1	<p>Size of outlet connection: 1 1/4 inch  Immersion depth: 772 mm  Flange size for motor: FT130</p> <p>Electrical data:  Motor standard: IEC  Motor type: 100LC  IE Efficiency class: IE3  Rated power - P2: 3 kW  Mains frequency: 50 Hz  Suitable for 50/60 Hz: N  Rated voltage: 3 x 220-240D/380-415Y V  Rated current: 11.0/6.30 A  Starting current: 840-920 %  Cos phi - power factor: 0.87-0.82  Rated speed: 2900-2920 rpm  Efficiency: IE3 87,1%  Motor efficiency at full load: 87.1 %  Motor efficiency at 3/4 load: 88.0 %  Motor efficiency at 1/2 load: 87.7 %  Number of poles: 2  Enclosure class (IEC 34-5): 55 Dust/Jetting  Insulation class (IEC 85): F  Motor No: 85U05510</p> <p>Others:  Terminal box position: 6  Minimum efficiency index, MEI ≥: 0.70  Net weight: 32.6 kg  Gross weight: 36.8 kg  Shipping volume: 0.108 m<sup>3</sup>  Danish VVS No.: 386963036</p>

## 98511283 MTR 3-36/36 A-W-A-HUUV 50 Hz

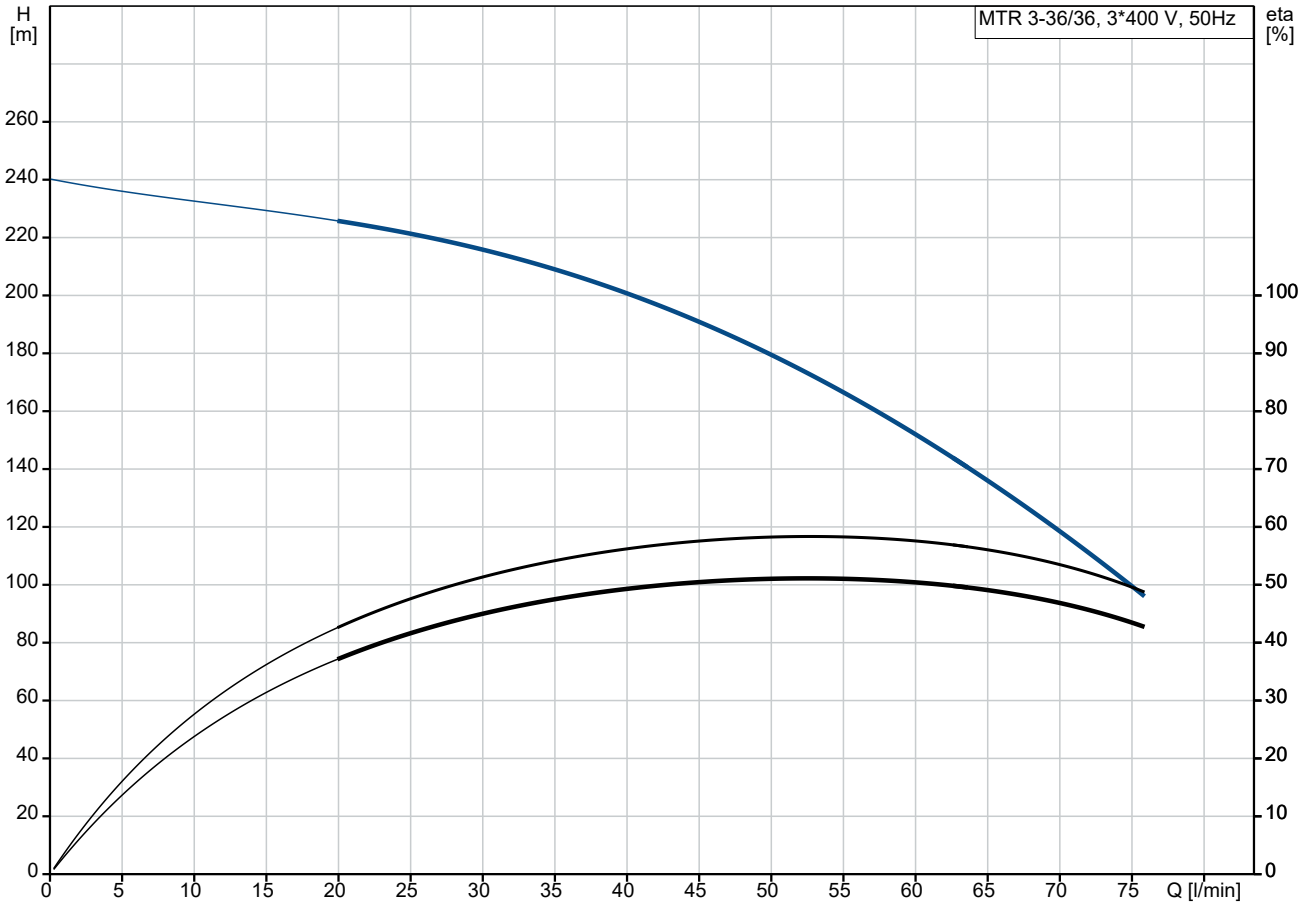

Pumped liquid = Water  
 Liquid temperature during operation = 20 °C  
 Density = 998.2 kg/m<sup>3</sup>

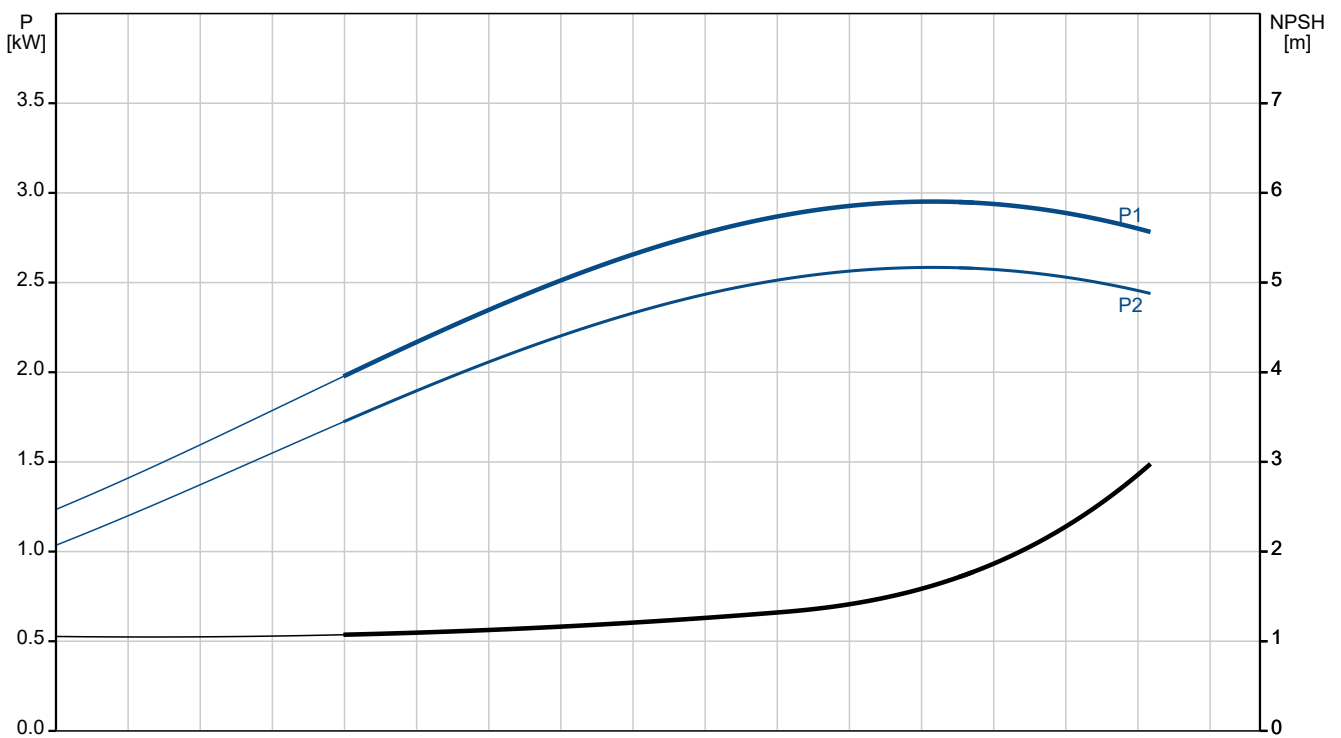

Description	Value
<b>General information:</b>	
Product name:	MTR 3-36/36 A-W-A-HUUV
Product No:	98511283
EAN number:	5711496360596
<b>Technical:</b>	
Pump speed on which pump data are based:	2902 rpm
Rated flow:	50 l/min
Rated head:	185.6 m
Chambers:	36
Impellers:	36
Number of reduced-diameter impellers:	0
Drainage back to tank:	N
Pump orientation:	Vertical
Code for shaft seal:	HUUV
Approvals:	CE,EAC
Curve tolerance:	ISO9906:2012 3B
Pump version:	A
Model:	A
<b>Materials:</b>	
Pump head:	Cast iron
Pump head:	EN 1561 EN-GJL-200
Pump head:	ASTM A48-25B
Impeller:	Stainless steel
Impeller:	EN 1.4301
Impeller:	AISI 304
Material code:	A
<b>Installation:</b>	
t max amb:	60 °C
Maximum operating pressure:	25 bar
Max pressure at stated temp:	25 bar / 90 °C
Type of connection:	G internal thread
Size of outlet connection:	1 1/4 inch
Immersion depth:	772 mm
Flange size for motor:	FT130
Connect code:	W </td
<b>Liquid:</b>	
Pumped liquid:	Water
Liquid temperature range:	-10 .. 90 °C
Selected liquid temperature:	20 °C
Density:	998.2 kg/m <sup>3</sup>
<b>Electrical data:</b>	
Motor standard:	IEC
Motor type:	100LC
IE Efficiency class:	IE3
Rated power - P2:	3 kW
Mains frequency:	50 Hz
Suitable for 50/60 Hz:	N
Rated voltage:	3 x 220-240D/380-415V V
Rated current:	11.0/6.30 A
Starting current:	840-920 %
Cos phi - power factor:	0.87-0.82
Rated speed:	2900-2920 rpm
Efficiency:	IE3 87,1%
Motor efficiency at full load:	87.1 %
Motor efficiency at 3/4 load:	88.0 %
Motor efficiency at 1/2 load:	87.7 %

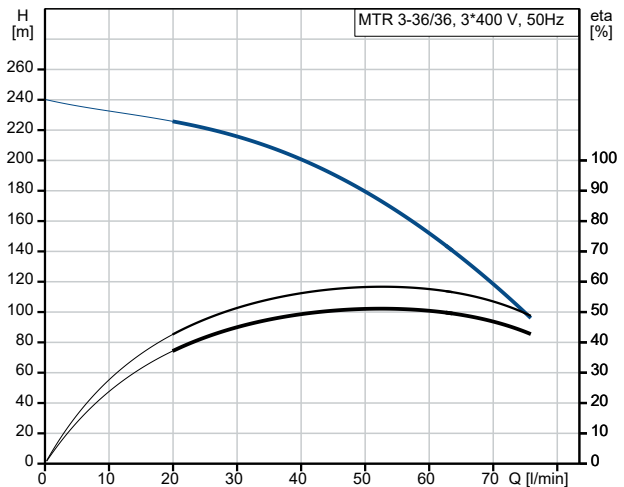

Pumped liquid = Water  
Liquid temperature during operation = 20 °C  
Density = 998.2 kg/m<sup>3</sup>

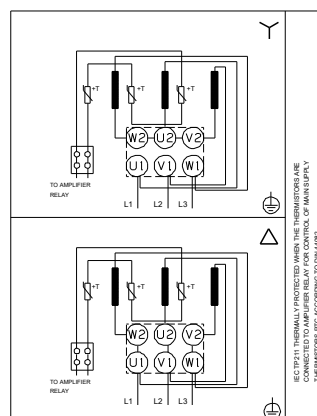
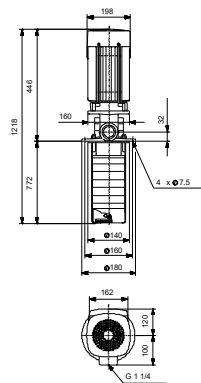
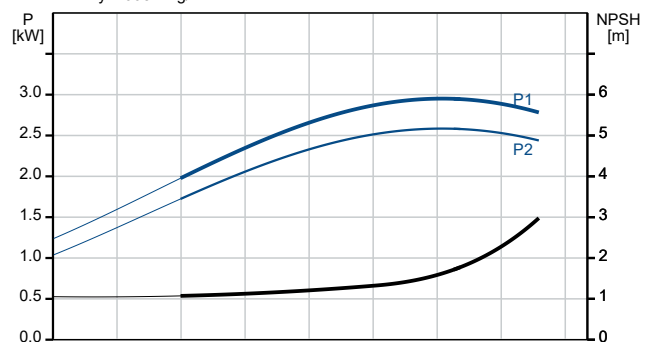



Company name:

Created by:

Phone:

Date:

30/12/2022

Description	Value
Number of poles:	2
Enclosure class (IEC 34-5):	55 Dust/Jetting
Insulation class (IEC 85):	F
Built-in motor protection:	PTC
Motor No:	85U05510
<b>Controls:</b>	
Frequency converter:	NONE
<b>Others:</b>	
Terminal box position:	6
Minimum efficiency index, MEI $\geq$ :	0.70
Net weight:	32.6 kg
Gross weight:	36.8 kg
Shipping volume:	0.108 m <sup>3</sup>
Danish VVS No.:	386963036

## 98511283 MTR 3-36/36 A-W-A-HUUV 50 Hz

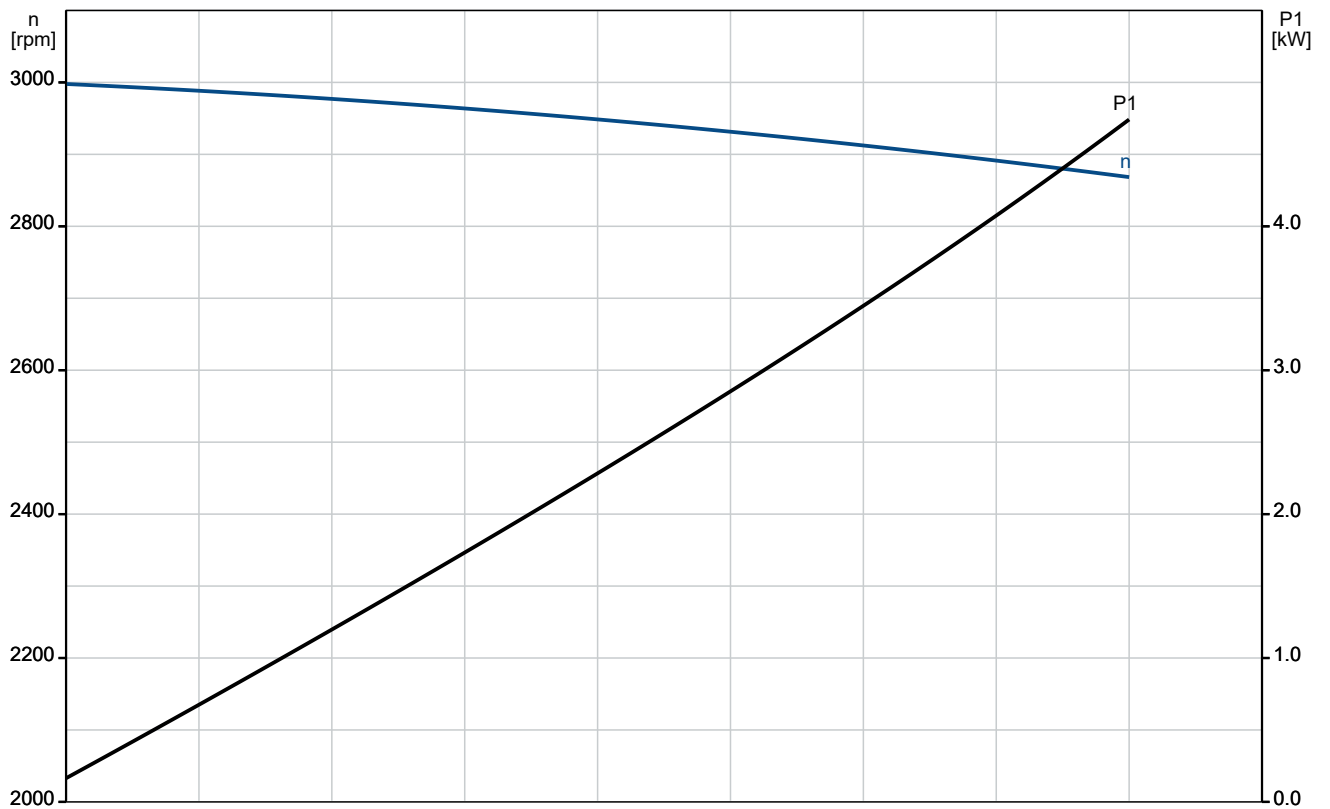
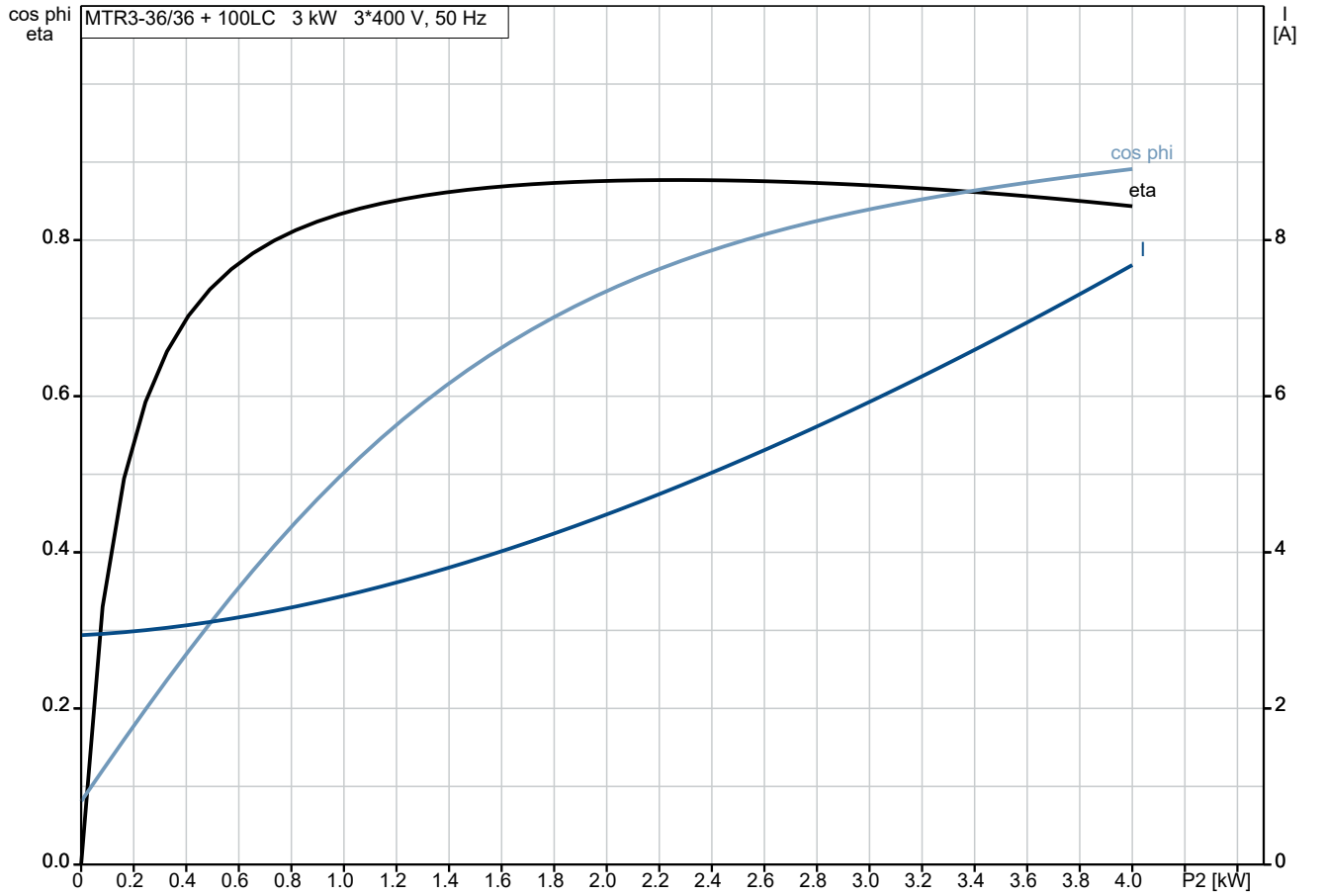

## 98511283 MTR 3-36/36 A-W-A-HUUV 50 Hz

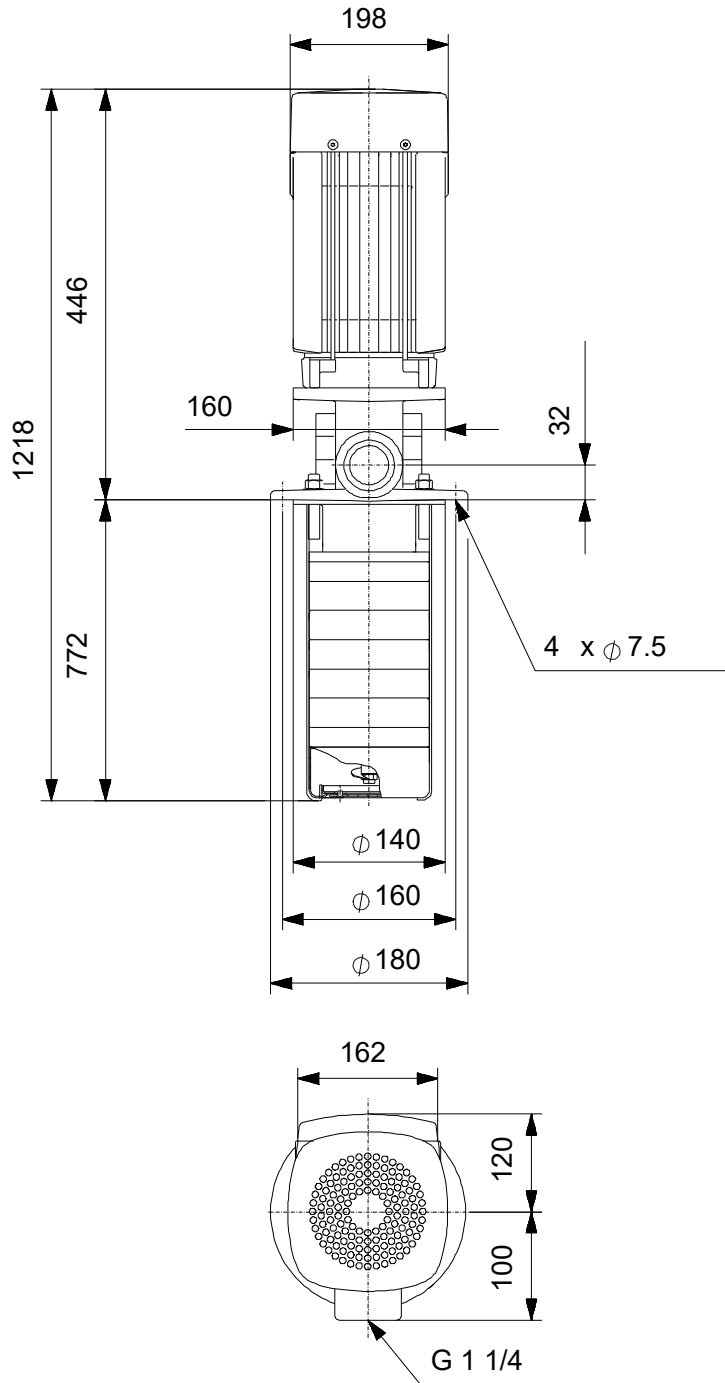

Note! All units are in [mm] unless others are stated.  
Disclaimer: This simplified dimensional drawing does not show all details.

## 98511283 MTR 3-36/36 A-W-A-HUUV 50 Hz



IEC TP211 THERMALLY PROTECTED WHEN THE THERMISTORS ARE  
CONNECTED TO AMPLIFIER RELAY FOR CONTROL OF MAIN SUPPLY  
THERMISTORS PTC ACCORDING TO DIN 44082

Note! All units are in [mm] unless others are stated.

