

Qty.	Description
1	<p data-bbox="204 163 488 185">MTR 10-8/8 A-W-A-HUUV</p>  <p data-bbox="204 483 478 506">Product No.: On request</p> <p data-bbox="204 544 1430 618">Multistage, immersible, self-priming, centrifugal pump for vertical installation in tanks etc. The pump head and base are in cast iron – all other wetted parts are in stainless steel. The pump has the following characteristics:</p> <ul data-bbox="240 629 1115 741" style="list-style-type: none"> • Dimensions according to DIN 5440. • Impellers, intermediate chambers and spline shaft are made of Stainless steel. • Mechanical shaft seal according to EN 12756. • Power transmission via sintered metal split coupling. <p data-bbox="204 750 1430 797">A cartridge shaft seal ensures high reliability, safe handling, and easy access and service. The pump is fitted with a 3-phase, fan-cooled asynchronous motor.</p> <p data-bbox="204 837 300 860">Controls:</p> <p data-bbox="204 869 636 891">Frequency converter: NONE</p> <p data-bbox="204 927 276 949">Liquid:</p> <p data-bbox="204 958 632 981">Pumped liquid: Water</p> <p data-bbox="204 990 687 1012">Liquid temperature range: -10 .. 90 °C</p> <p data-bbox="204 1021 632 1043">Selected liquid temperature: 20 °C</p> <p data-bbox="204 1052 695 1075">Density: 998.2 kg/m³</p> <p data-bbox="204 1111 312 1133">Technical:</p> <p data-bbox="204 1142 818 1164">Pump speed on which pump data are based: 2902 rpm</p> <p data-bbox="204 1173 667 1196">Rated flow: 167 l/min</p> <p data-bbox="204 1205 639 1227">Rated head: 66.8 m</p> <p data-bbox="204 1236 576 1258">Chambers: 8</p> <p data-bbox="204 1267 576 1290">Drainage back to tank: N</p> <p data-bbox="204 1299 647 1321">Pump orientation: Vertical</p> <p data-bbox="204 1330 632 1352">Code for shaft seal: HUUV</p> <p data-bbox="204 1361 655 1384">Approvals: CE,EAC</p> <p data-bbox="204 1393 759 1415">Curve tolerance: ISO9906:2012 3B</p> <p data-bbox="204 1451 308 1473">Materials:</p> <p data-bbox="204 1482 802 1547">Pump head: Cast iron EN 1561 EN-GJL-200 ASTM A48-25B</p> <p data-bbox="204 1556 722 1637">Impeller: Stainless steel EN 1.4301 AISI 304</p> <p data-bbox="204 1673 325 1695">Installation:</p> <p data-bbox="204 1704 632 1727">t max amb: 60 °C</p> <p data-bbox="204 1736 632 1758">Maximum operating pressure: 25 bar</p> <p data-bbox="204 1767 716 1789">Max pressure at stated temp: 25 bar / 90 °C</p> <p data-bbox="204 1798 746 1821">Type of connection: G internal thread</p> <p data-bbox="204 1830 632 1852">Size of outlet connection: 2 inch</p> <p data-bbox="204 1861 655 1883">Immersion depth: 328 mm</p> <p data-bbox="204 1892 632 1915">Flange size for motor: FT130</p> <p data-bbox="204 1951 363 1973">Electrical data:</p> <p data-bbox="204 1982 608 2004">Motor standard: IEC</p> <p data-bbox="204 2013 632 2036">Motor type: 100LC</p> <p data-bbox="204 2045 600 2067">IE Efficiency class: IE3</p> <p data-bbox="204 2076 632 2098">Rated power - P2: 3 kW</p>

Qty.	Description
1	<p>Mains frequency: 50 Hz Suitable for 50/60 Hz: N Rated voltage: 3 x 380-415D V Rated current: 6.3 A Starting current: 840-920 % Cos phi - power factor: 0.87-0.82 Rated speed: 2900-2920 rpm Efficiency: IE3 87,1% Motor efficiency at full load: 87.1 % Motor efficiency at 3/4 load: 88.0 % Motor efficiency at 1/2 load: 87.7 % Number of poles: 2 Enclosure class (IEC 34-5): 55 Dust/Jetting Insulation class (IEC 85): F Motor No: 85U15510</p> <p>Others: Terminal box position: 6 Minimum efficiency index, MEI ≥: 0.70 Net weight: 40.3 kg Gross weight: 43.8 kg Shipping volume: 0.09 m³ Country of origin: HU Custom tariff no.: 84137075</p>

On request MTR 10-8/8 A-W-A-HUUV 50 Hz

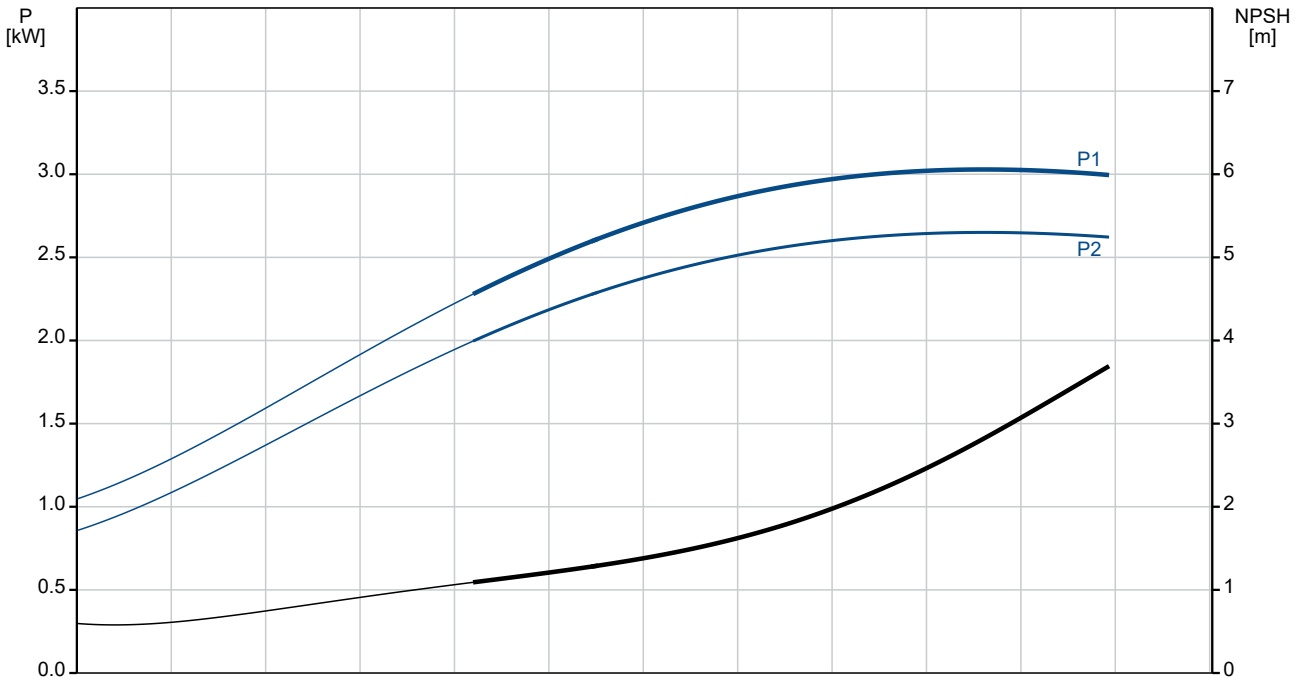
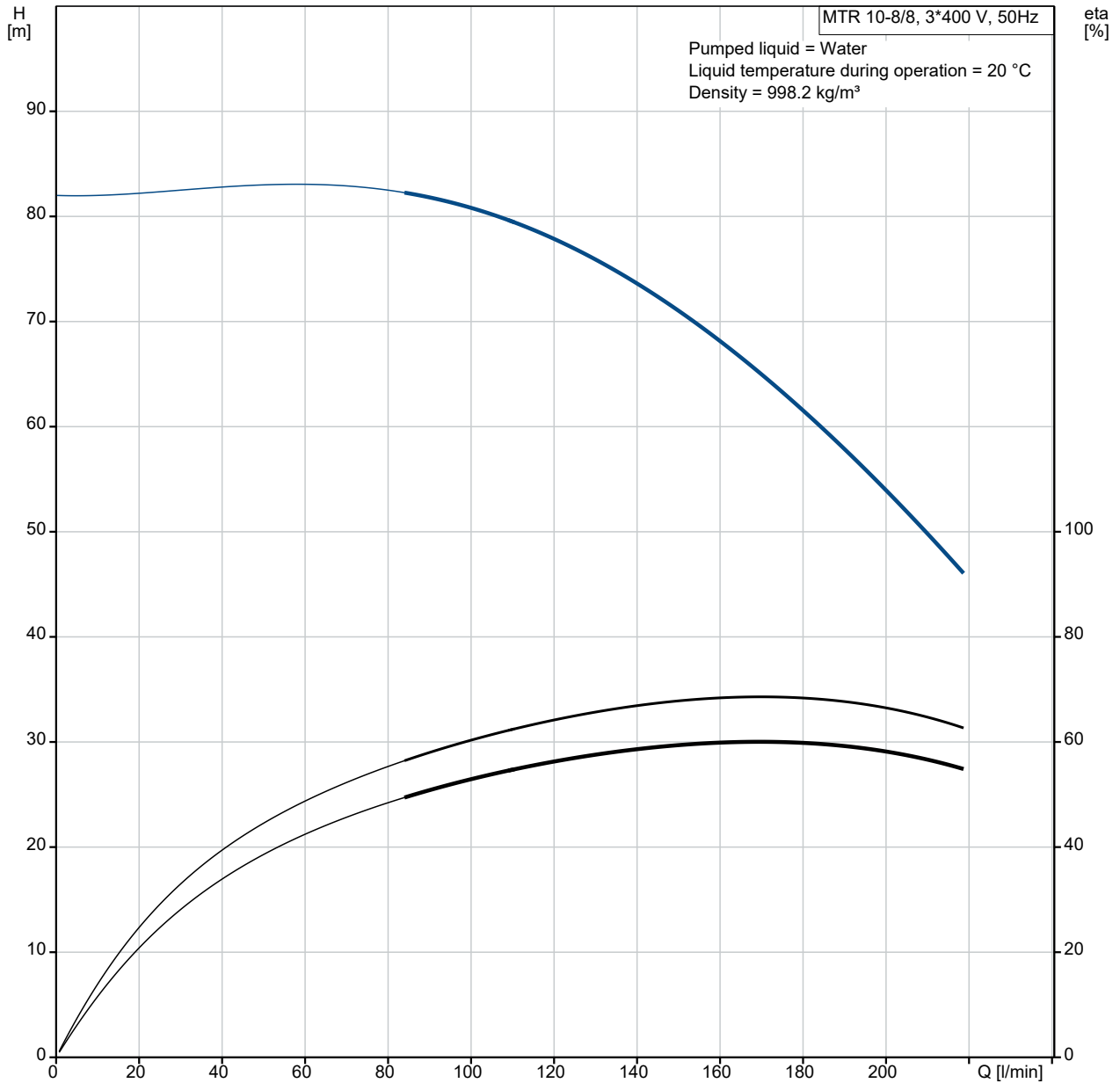

Description	Value
General information:	
Product name:	MTR 10-8/8 A-W-A-HUUV
Product No:	On request
EAN number:	On request
Technical:	
Pump speed on which pump data are based:	2902 rpm
Rated flow:	167 l/min
Rated head:	66.8 m
Chambers:	8
Impellers:	8
Number of reduced-diameter impellers:	0
Drainage back to tank:	N
Pump orientation:	Vertical
Code for shaft seal:	HUUV
Approvals:	CE,EAC
Curve tolerance:	ISO9906:2012 3B
Pump version:	A
Model:	A
Materials:	
Pump head:	Cast iron
Pump head:	EN 1561 EN-GJL-200
Pump head:	ASTM A48-25B
Impeller:	Stainless steel
Impeller:	EN 1.4301
Impeller:	AISI 304
Material code:	A
Installation:	
t max amb:	60 °C
Maximum operating pressure:	25 bar
Max pressure at stated temp:	25 bar / 90 °C
Type of connection:	G internal thread
Size of outlet connection:	2 inch
Immersion depth:	328 mm
Flange size for motor:	FT130
Connect code:	W </td
Liquid:	
Pumped liquid:	Water
Liquid temperature range:	-10 .. 90 °C
Selected liquid temperature:	20 °C
Density:	998.2 kg/m ³
Electrical data:	
Motor standard:	IEC
Motor type:	100LC
IE Efficiency class:	IE3
Rated power - P2:	3 kW
Mains frequency:	50 Hz
Suitable for 50/60 Hz:	N
Rated voltage:	3 x 380-415D V
Rated current:	6.3 A
Starting current:	840-920 %
Cos phi - power factor:	0.87-0.82
Rated speed:	2900-2920 rpm
Efficiency:	IE3 87,1%
Motor efficiency at full load:	87.1 %
Motor efficiency at 3/4 load:	88.0 %
Motor efficiency at 1/2 load:	87.7 %
Number of poles:	2
Enclosure class (IEC 34-5):	55 Dust/Jetting
Insulation class (IEC 85):	F
Built-in motor protection:	PTC
Motor No:	85U15510
Controls:	

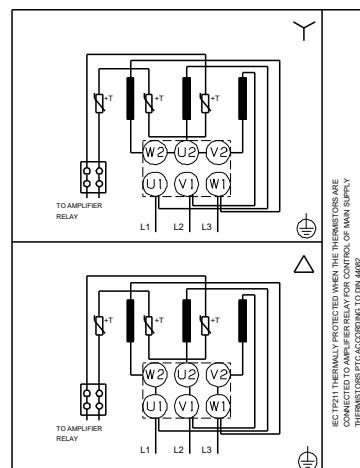
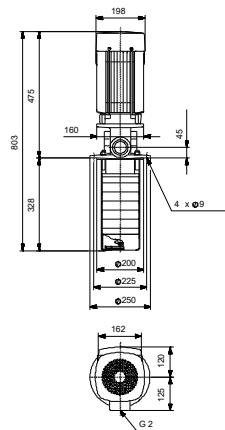
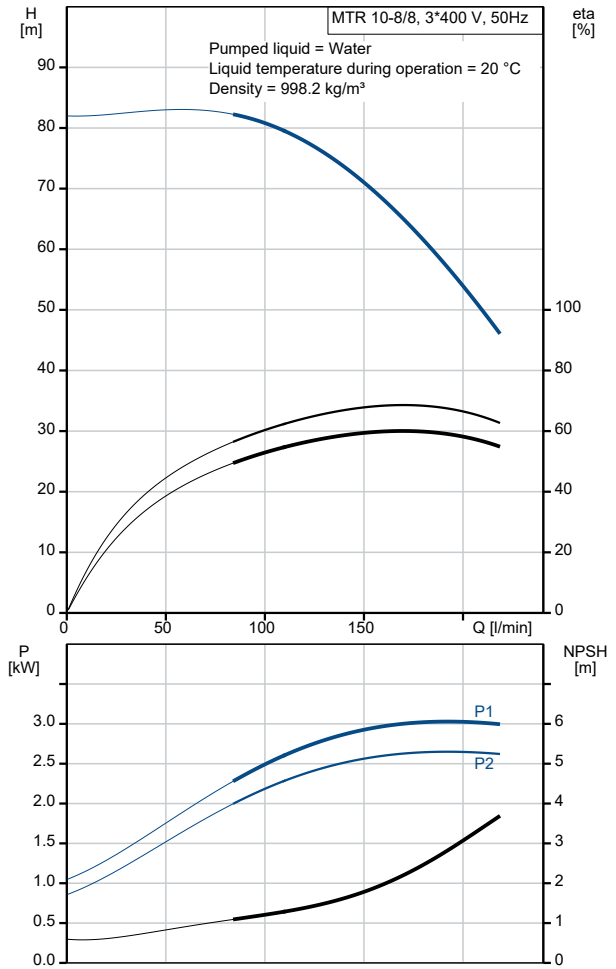

Description	Value
Frequency converter:	NONE
Others:	
Terminal box position:	6
Minimum efficiency index, MEI ≥:	0.70
Net weight:	40.3 kg
Gross weight:	43.8 kg
Shipping volume:	0.09 m ³
Country of origin:	HU
Custom tariff no.:	84137075

On request MTR 10-8/8 A-W-A-HUUV 50 Hz

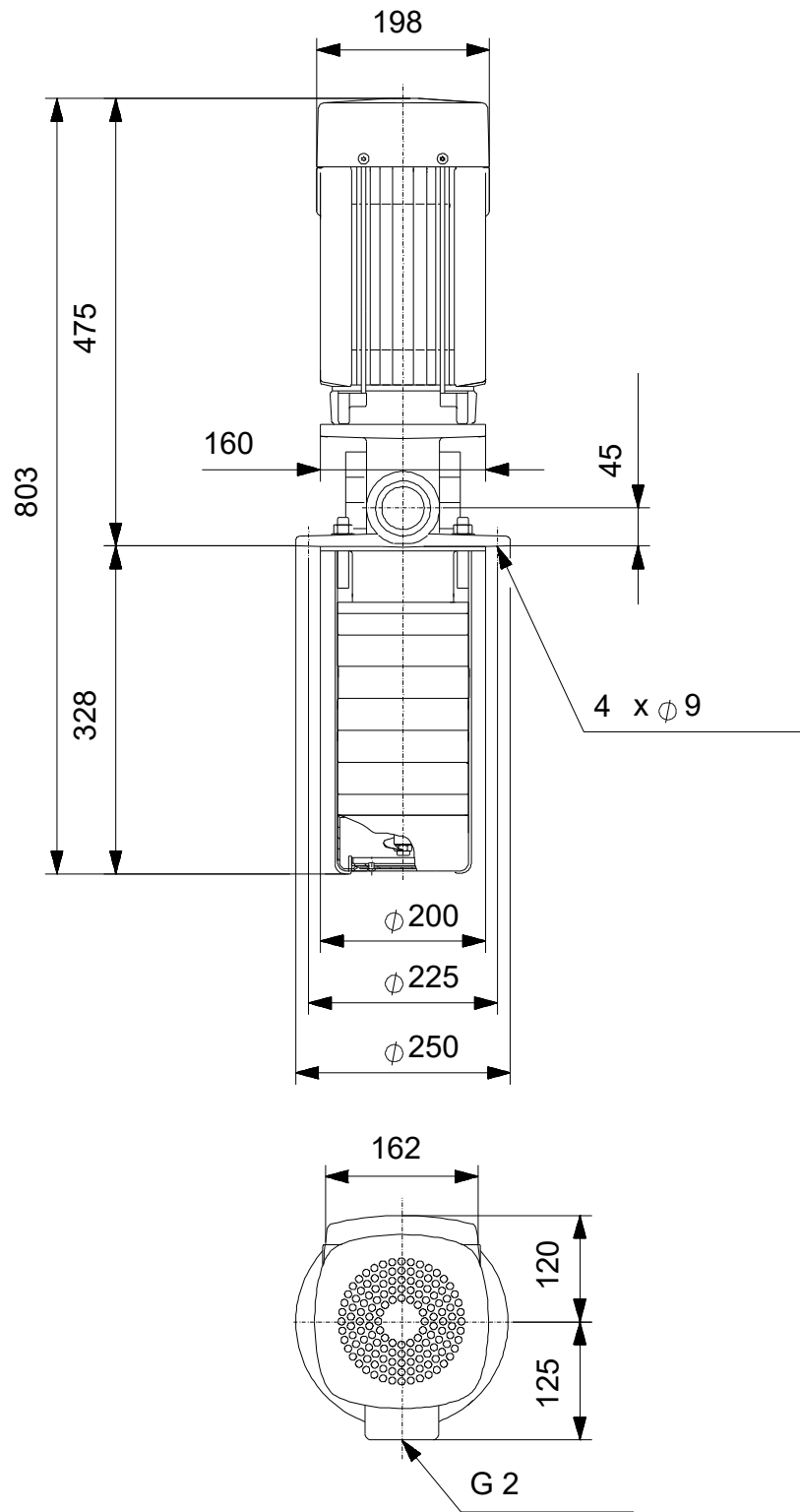

Note! All units are in [mm] unless others are stated.
Disclaimer: This simplified dimensional drawing does not show all details.

On request MTR 10-8/8 A-W-A-HUUV 50 Hz



IEC TP211 THERMALLY PROTECTED WHEN THE THERMISTORS ARE
CONNECTED TO AMPLIFIER RELAY FOR CONTROL OF MAIN SUPPLY
THERMISTORS PTC ACCORDING TO DIN 44082

Note! All units are in [mm] unless others are stated.

Order Data:

Position	Your pos.	Product name	Amount	Product No	Total
		MTR 10-8/8	1	On request	Price on request