

Qty.	Description
1	<b>MTR 15-3/3 A-W-A-HUUV</b>
	
	Product No.: On request
	Multistage, immersible, self-priming, centrifugal pump for vertical installation in tanks etc. The pump head and base are in cast iron – all other wetted parts are in stainless steel. The pump has the following characteristics:
	<ul style="list-style-type: none"> <li>• Dimensions according to DIN 5440.</li> <li>• Impellers, intermediate chambers and spline shaft are made of Stainless steel.</li> <li>• Mechanical shaft seal according to EN 12756.</li> <li>• Power transmission via sintered metal split coupling.</li> </ul>
	A cartridge shaft seal ensures high reliability, safe handling, and easy access and service. The pump is fitted with a 3-phase, fan-cooled asynchronous motor.
	<b>Controls:</b> Frequency converter: NONE
	<b>Liquid:</b> Pumped liquid: Water Liquid temperature range: -10 .. 90 °C Selected liquid temperature: 20 °C Density: 998.2 kg/m <sup>3</sup>
	<b>Technical:</b> Pump speed on which pump data are based: 2902 rpm Rated flow: 283 l/min Rated head: 34.2 m Chambers: 3 Drainage back to tank: N Pump orientation: Vertical Code for shaft seal: HUUV Approvals: CE,EAC Curve tolerance: ISO9906:2012 3B
	<b>Materials:</b> Pump head: Cast iron EN 1561 EN-GJL-200 ASTM A48-25B Impeller: Stainless steel EN 1.4301 AISI 304
	<b>Installation:</b> t max amb: 60 °C Maximum operating pressure: 25 bar Max pressure at stated temp: 25 bar / 90 °C Type of connection: G internal thread Size of outlet connection: 2 inch Immersion depth: 223 mm Flange size for motor: FT130
	<b>Electrical data:</b> Motor standard: IEC Motor type: 100LC IE Efficiency class: IE3 Rated power - P2: 3 kW

Qty.	Description
1	<p>Mains frequency: 50 Hz  Suitable for 50/60 Hz: N  Rated voltage: 3 x 380-415D V  Rated current: 6.3 A  Starting current: 840-920 %  Cos phi - power factor: 0.87-0.82  Rated speed: 2900-2920 rpm  Efficiency: IE3 87,1%  Motor efficiency at full load: 87.1 %  Motor efficiency at 3/4 load: 88.0 %  Motor efficiency at 1/2 load: 87.7 %  Number of poles: 2  Enclosure class (IEC 34-5): 55 Dust/Jetting  Insulation class (IEC 85): F  Motor No: 85U15510</p> <p>Others:  Terminal box position: 6  Minimum efficiency index, MEI ≥: 0.70  Net weight: 41.1 kg  Gross weight: 44.6 kg  Shipping volume: 0.081 m<sup>3</sup>  Country of origin: HU  Custom tariff no.: 84137075</p>

# On request MTR 15-3/3 A-W-A-HUUV 50 Hz

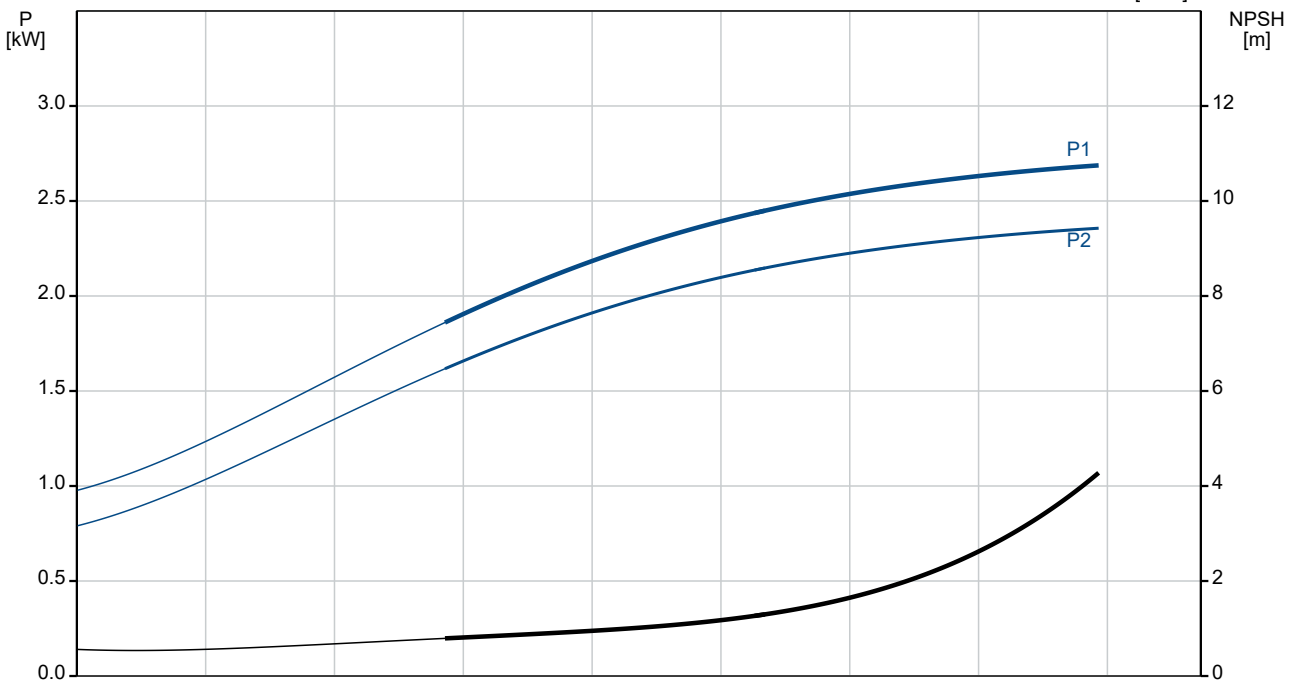
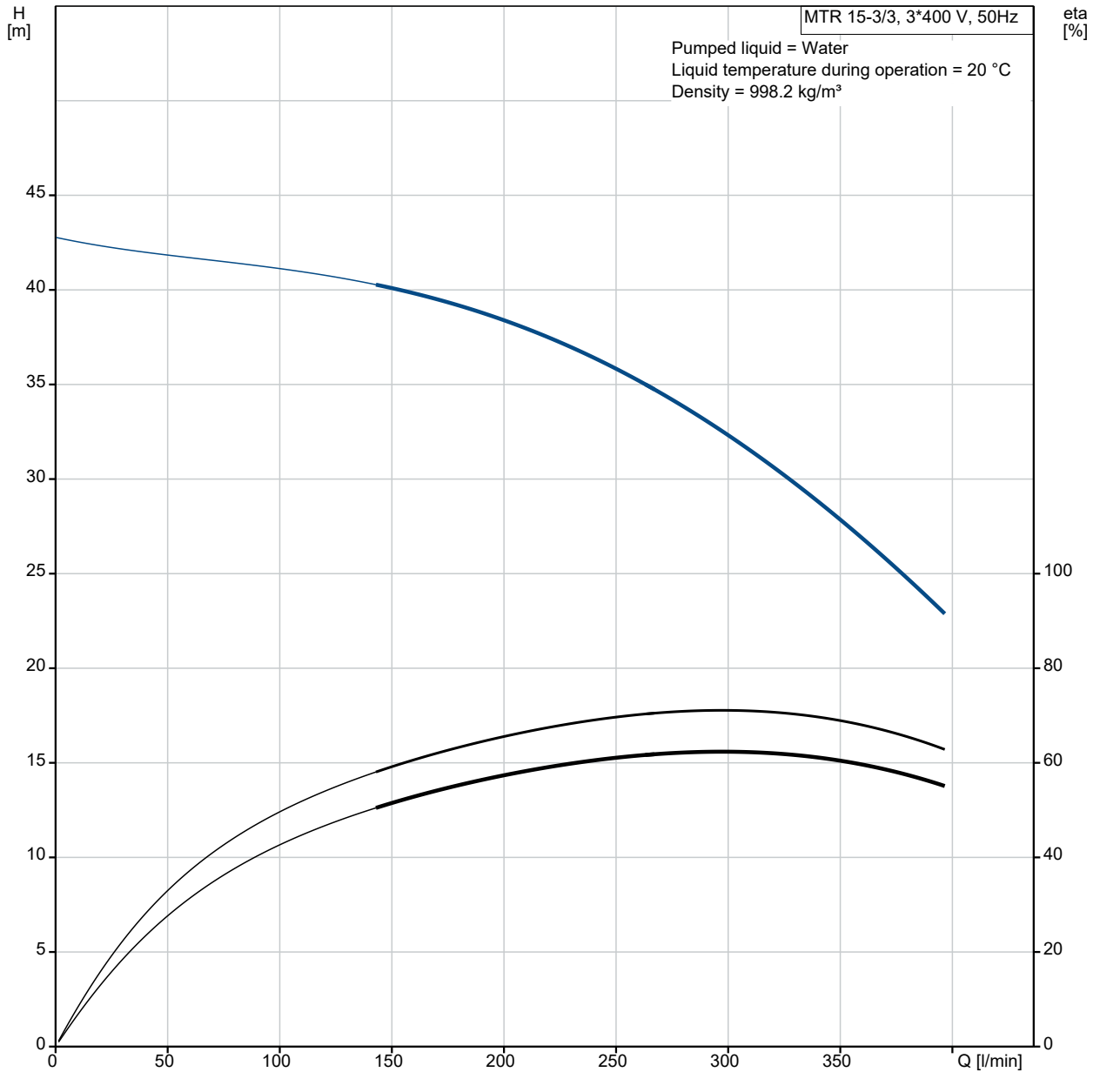

Description	Value
<b>General information:</b>	
Product name:	MTR 15-3/3 A-W-A-HUUUV
Product No:	On request
EAN number:	On request
<b>Technical:</b>	
Pump speed on which pump data are based:	2902 rpm
Rated flow:	283 l/min
Rated head:	34.2 m
Chambers:	3
Impellers:	3
Number of reduced-diameter impellers:	0
Drainage back to tank:	N
Pump orientation:	Vertical
Code for shaft seal:	HUUUV
Approvals:	CE,EAC
Curve tolerance:	ISO9906:2012 3B
Pump version:	A
Model:	A
<b>Materials:</b>	
Pump head:	Cast iron
Pump head:	EN 1561 EN-GJL-200
Pump head:	ASTM A48-25B
Impeller:	Stainless steel
Impeller:	EN 1.4301
Impeller:	AISI 304
Material code:	A
<b>Installation:</b>	
t max amb:	60 °C
Maximum operating pressure:	25 bar
Max pressure at stated temp:	25 bar / 90 °C
Type of connection:	G internal thread
Size of outlet connection:	2 inch
Immersion depth:	223 mm
Flange size for motor:	FT130
Connect code:	W </td
<b>Liquid:</b>	
Pumped liquid:	Water
Liquid temperature range:	-10 .. 90 °C
Selected liquid temperature:	20 °C
Density:	998.2 kg/m <sup>3</sup>
<b>Electrical data:</b>	
Motor standard:	IEC
Motor type:	100LC
IE Efficiency class:	IE3
Rated power - P2:	3 kW
Mains frequency:	50 Hz
Suitable for 50/60 Hz:	N
Rated voltage:	3 x 380-415D V
Rated current:	6.3 A
Starting current:	840-920 %
Cos phi - power factor:	0.87-0.82
Rated speed:	2900-2920 rpm
Efficiency:	IE3 87,1%
Motor efficiency at full load:	87.1 %
Motor efficiency at 3/4 load:	88.0 %
Motor efficiency at 1/2 load:	87.7 %
Number of poles:	2
Enclosure class (IEC 34-5):	55 Dust/Jetting
Insulation class (IEC 85):	F
Built-in motor protection:	PTC
Motor No:	85U15510
<b>Controls:</b>	

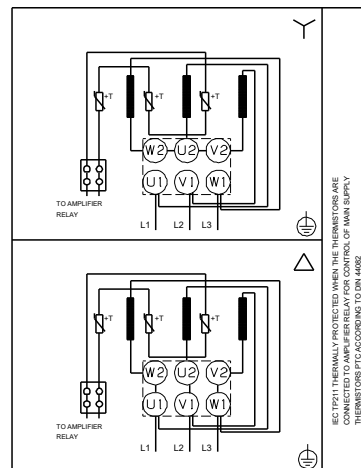
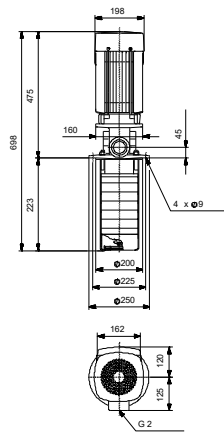
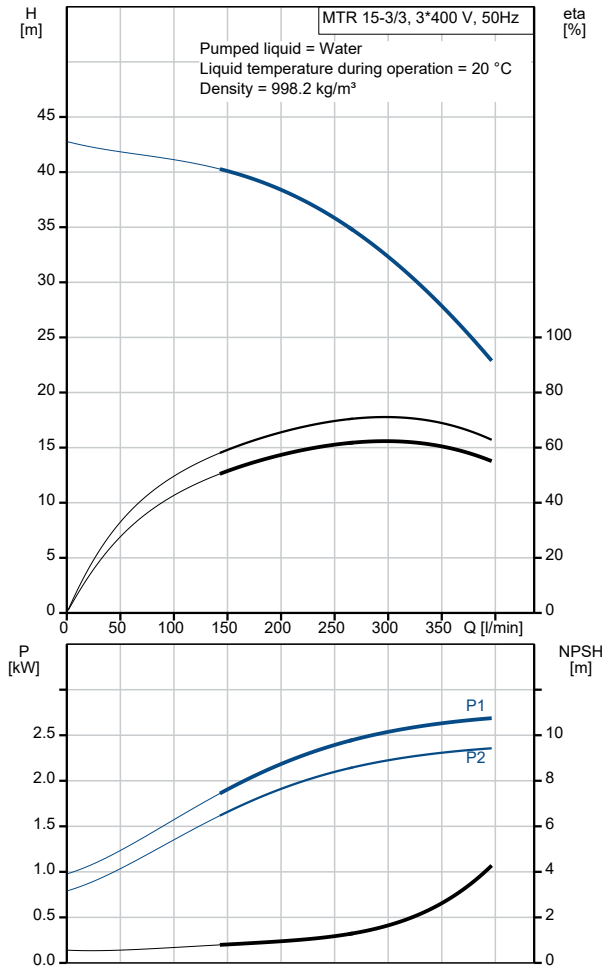

Description	Value
Frequency converter:	NONE
<b>Others:</b>	
Terminal box position:	6
Minimum efficiency index, MEI ≥:	0.70
Net weight:	41.1 kg
Gross weight:	44.6 kg
Shipping volume:	0.081 m <sup>3</sup>
Country of origin:	HU
Custom tariff no.:	84137075

# On request MTR 15-3/3 A-W-A-HUUV 50 Hz

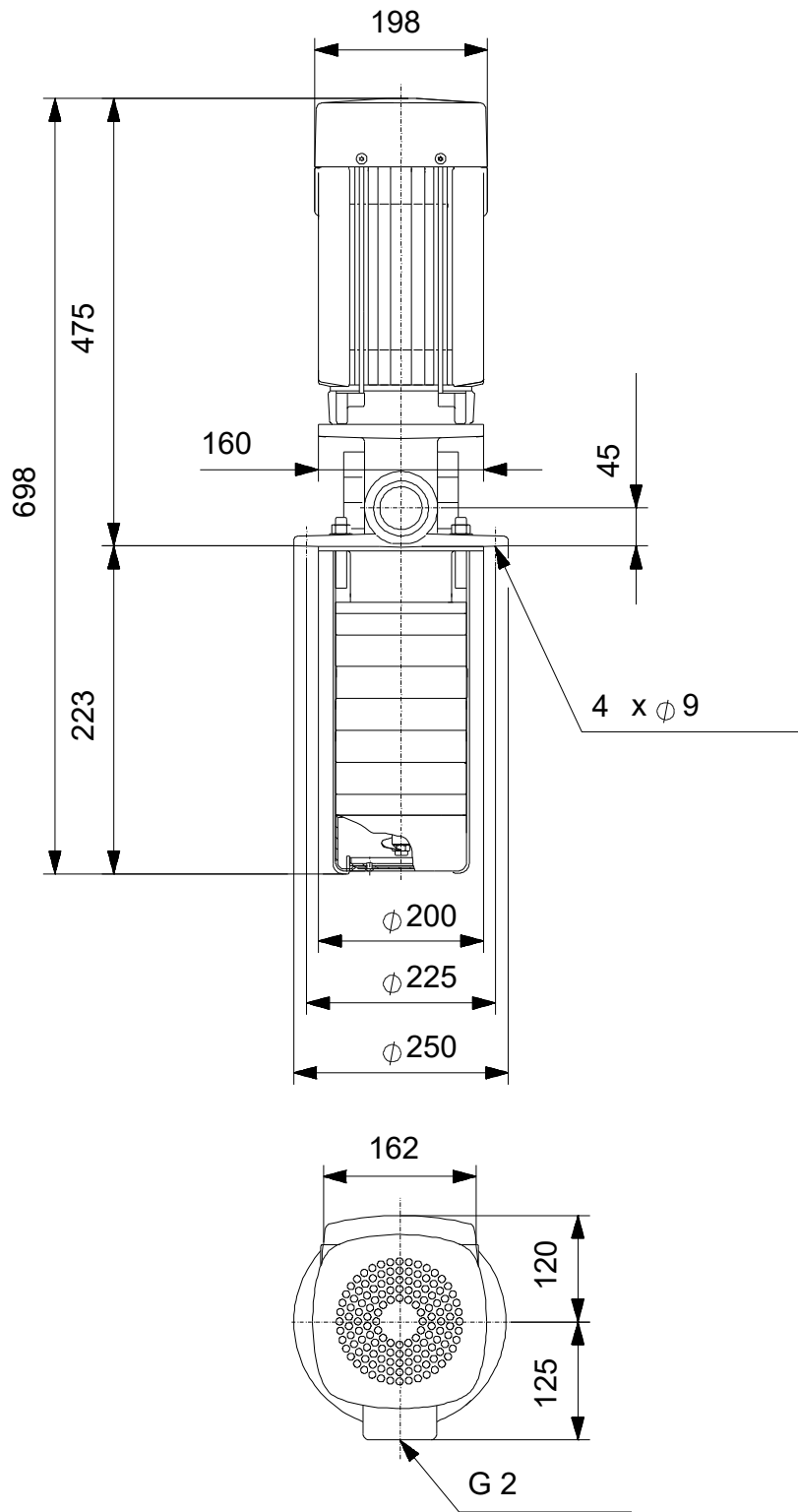

Note! All units are in [mm] unless others are stated.  
Disclaimer: This simplified dimensional drawing does not show all details.

**On request MTR 15-3/3 A-W-A-HUUV 50 Hz**



IEC TP211 THERMALLY PROTECTED WHEN THE THERMISTORS ARE  
CONNECTED TO AMPLIFIER RELAY FOR CONTROL OF MAIN SUPPLY  
THERMISTORS PTC ACCORDING TO DIN 44082

Note! All units are in [mm] unless others are stated.

