

Qty.	Description
1	<p data-bbox="204 163 488 185">MTR 15-5/5 A-W-A-HUUV</p>  <p data-bbox="204 483 480 506">Product No.: On request</p> <p data-bbox="204 544 1430 618">Multistage, immersible, self-priming, centrifugal pump for vertical installation in tanks etc. The pump head and base are in cast iron – all other wetted parts are in stainless steel. The pump has the following characteristics:</p> <ul data-bbox="240 629 1117 745" style="list-style-type: none"> • Dimensions according to DIN 5440. • Impellers, intermediate chambers and spline shaft are made of Stainless steel. • Mechanical shaft seal according to EN 12756. • Power transmission via sintered metal split coupling. <p data-bbox="204 750 1430 799">A cartridge shaft seal ensures high reliability, safe handling, and easy access and service. The pump is fitted with a 3-phase, fan-cooled asynchronous motor.</p> <p data-bbox="204 837 300 860">Controls:</p> <p data-bbox="204 866 636 889">Frequency converter: NONE</p> <p data-bbox="204 927 276 949">Liquid:</p> <p data-bbox="204 956 632 978">Pumped liquid: Water</p> <p data-bbox="204 985 691 1008">Liquid temperature range: -10 .. 90 °C</p> <p data-bbox="204 1014 632 1037">Selected liquid temperature: 20 °C</p> <p data-bbox="204 1043 695 1066">Density: 998.2 kg/m³</p> <p data-bbox="204 1104 316 1126">Technical:</p> <p data-bbox="204 1133 820 1155">Pump speed on which pump data are based: 2917 rpm</p> <p data-bbox="204 1162 667 1184">Rated flow: 283 l/min</p> <p data-bbox="204 1191 641 1214">Rated head: 56.4 m</p> <p data-bbox="204 1220 579 1243">Chambers: 5</p> <p data-bbox="204 1249 579 1272">Drainage back to tank: N</p> <p data-bbox="204 1279 647 1301">Pump orientation: Vertical</p> <p data-bbox="204 1308 636 1330">Code for shaft seal: HUUV</p> <p data-bbox="204 1337 657 1359">Approvals: CE,EAC</p> <p data-bbox="204 1366 759 1388">Curve tolerance: ISO9906:2012 3B</p> <p data-bbox="204 1426 309 1449">Materials:</p> <p data-bbox="204 1456 802 1543">Pump head: Cast iron EN 1561 EN-GJL-200 ASTM A48-25B</p> <p data-bbox="204 1550 724 1637">Impeller: Stainless steel EN 1.4301 AISI 304</p> <p data-bbox="204 1675 325 1697">Installation:</p> <p data-bbox="204 1704 628 1727">t max amb: 60 °C</p> <p data-bbox="204 1733 636 1756">Maximum operating pressure: 25 bar</p> <p data-bbox="204 1762 718 1785">Max pressure at stated temp: 25 bar / 90 °C</p> <p data-bbox="204 1792 746 1814">Type of connection: G internal thread</p> <p data-bbox="204 1821 632 1843">Size of outlet connection: 2 inch</p> <p data-bbox="204 1850 655 1872">Immersion depth: 313 mm</p> <p data-bbox="204 1879 636 1901">Flange size for motor: FT130</p> <p data-bbox="204 1939 363 1962">Electrical data:</p> <p data-bbox="204 1968 608 1991">Motor standard: IEC</p> <p data-bbox="204 1998 644 2020">Motor type: 112MC</p> <p data-bbox="204 2027 603 2049">IE Efficiency class: IE3</p> <p data-bbox="204 2056 624 2078">Rated power - P2: 4 kW</p>

Qty.	Description
1	<p>Mains frequency: 50 Hz Suitable for 50/60 Hz: N Rated voltage: 3 x 380-415D V Rated current: 7.9 A Starting current: 1000-1110 % Cos phi - power factor: 0.87-0.87 Rated speed: 2920-2940 rpm Efficiency: IE3 88,1% Motor efficiency at full load: 88.1 % Motor efficiency at 3/4 load: 88.6 % Motor efficiency at 1/2 load: 85.2 % Number of poles: 2 Enclosure class (IEC 34-5): 55 Dust/Jetting Insulation class (IEC 85): F Motor No: 85U15413</p> <p>Others: Terminal box position: 6 Minimum efficiency index, MEI \geq: 0.70 Net weight: 53 kg Gross weight: 56.5 kg Shipping volume: 0.09 m³ Danish VVS No.: 386967005 Country of origin: HU Custom tariff no.: 84137075</p>

On request MTR 15-5/5 A-W-A-HUUV 50 Hz

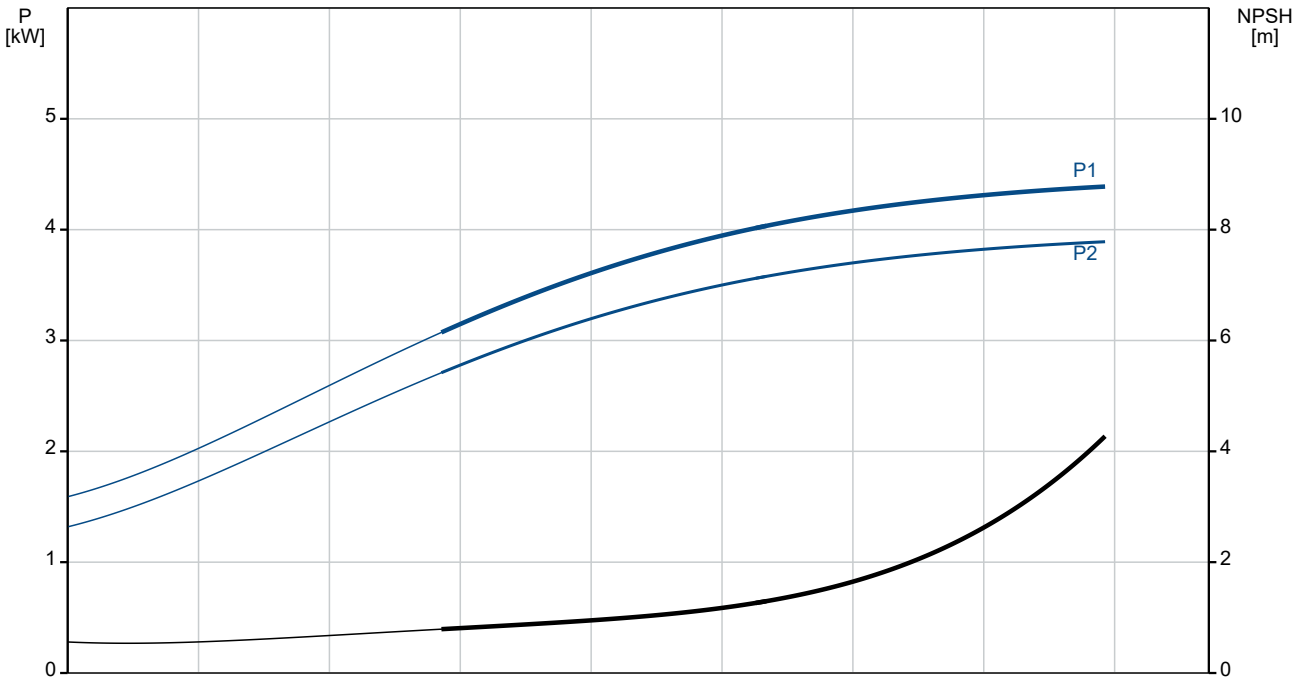
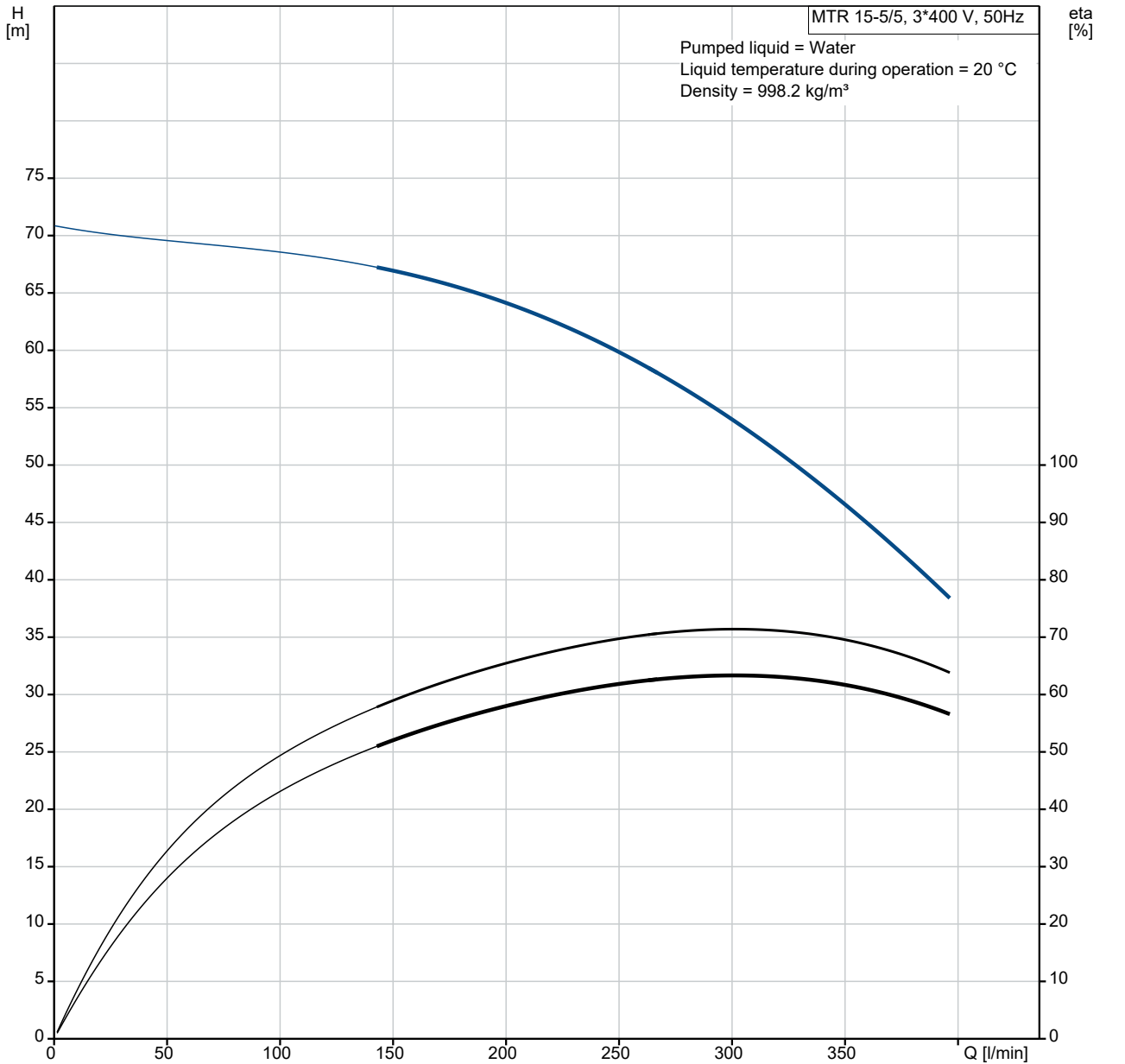

Description	Value
General information:	
Product name:	MTR 15-5/5 A-W-A-HUUUV
Product No:	On request
EAN number:	On request
Technical:	
Pump speed on which pump data are based:	2917 rpm
Rated flow:	283 l/min
Rated head:	56.4 m
Chambers:	5
Impellers:	5
Number of reduced-diameter impellers:	0
Drainage back to tank:	N
Pump orientation:	Vertical
Code for shaft seal:	HUUUV
Approvals:	CE, EAC
Curve tolerance:	ISO9906:2012 3B
Pump version:	A
Model:	A
Materials:	
Pump head:	Cast iron
Pump head:	EN 1561 EN-GJL-200
Pump head:	ASTM A48-25B
Impeller:	Stainless steel
Impeller:	EN 1.4301
Impeller:	AISI 304
Material code:	A
Installation:	
t max amb:	60 °C
Maximum operating pressure:	25 bar
Max pressure at stated temp:	25 bar / 90 °C
Type of connection:	G internal thread
Size of outlet connection:	2 inch
Immersion depth:	313 mm
Flange size for motor:	FT130
Connect code:	W </td
Liquid:	
Pumped liquid:	Water
Liquid temperature range:	-10 .. 90 °C
Selected liquid temperature:	20 °C
Density:	998.2 kg/m ³
Electrical data:	
Motor standard:	IEC
Motor type:	112MC
IE Efficiency class:	IE3
Rated power - P2:	4 kW
Mains frequency:	50 Hz
Suitable for 50/60 Hz:	N
Rated voltage:	3 x 380-415D V
Rated current:	7.9 A
Starting current:	1000-1110 %
Cos phi - power factor:	0.87-0.87
Rated speed:	2920-2940 rpm
Efficiency:	IE3 88,1%
Motor efficiency at full load:	88.1 %
Motor efficiency at 3/4 load:	88.6 %
Motor efficiency at 1/2 load:	85.2 %
Number of poles:	2
Enclosure class (IEC 34-5):	55 Dust/Jetting
Insulation class (IEC 85):	F
Built-in motor protection:	PTC
Motor No:	85U15413
Controls:	

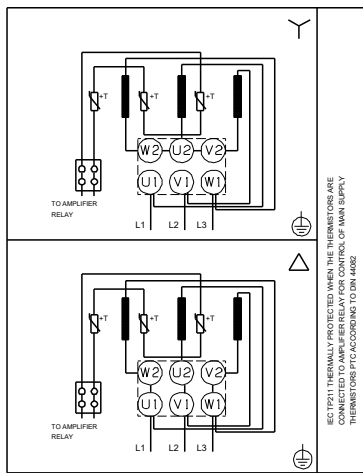
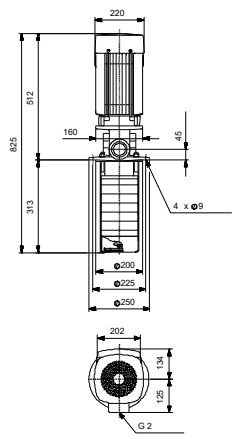
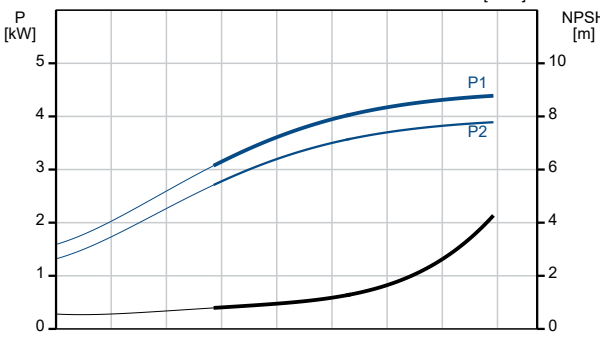
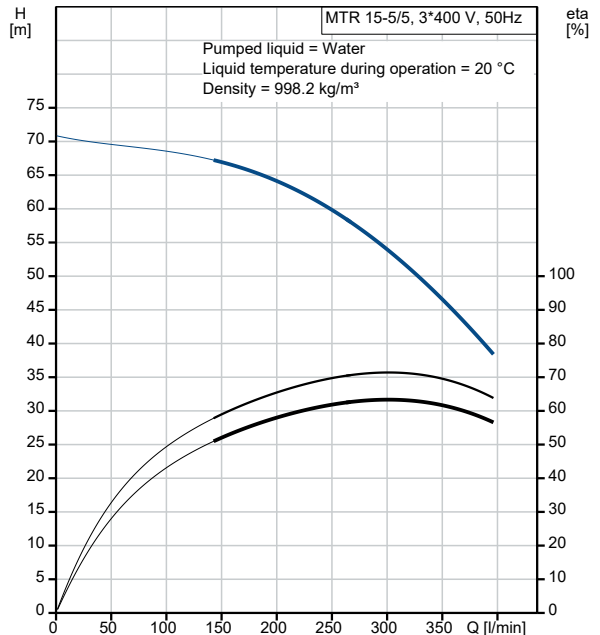

Description	Value
Frequency converter:	NONE
Others:	
Terminal box position:	6
Minimum efficiency index, MEI ≥:	0.70
Net weight:	53 kg
Gross weight:	56.5 kg
Shipping volume:	0.09 m ³
Danish VVS No.:	386967005
Country of origin:	HU
Custom tariff no.:	84137075

On request MTR 15-5/5 A-W-A-HUUV 50 Hz

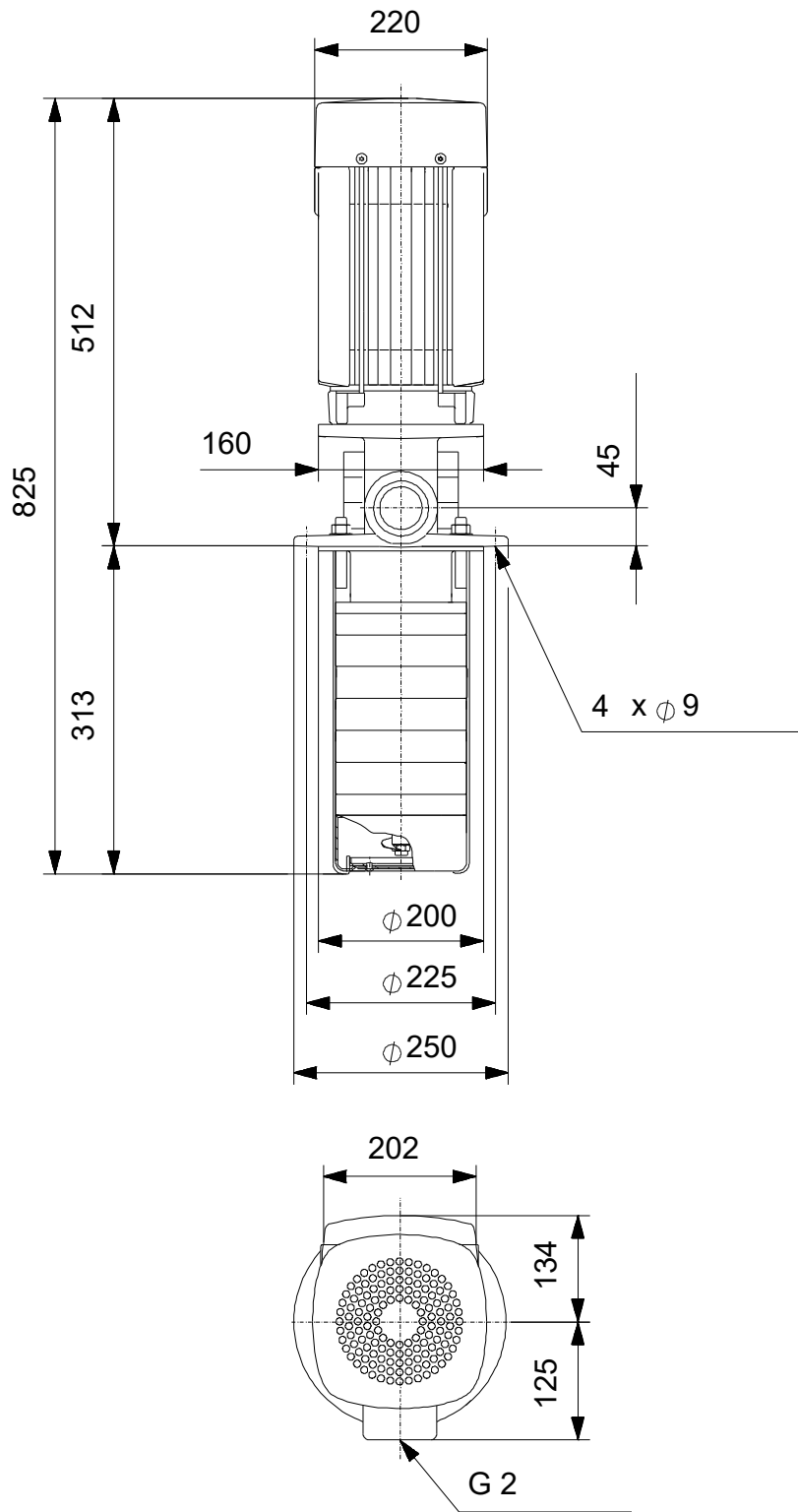

Note! All units are in [mm] unless others are stated.
Disclaimer: This simplified dimensional drawing does not show all details.

On request MTR 15-5/5 A-W-A-HUUV 50 Hz



IEC TP211 THERMALLY PROTECTED WHEN THE THERMISTORS ARE
 CONNECTED TO AMPLIFIER RELAY FOR CONTROL OF MAIN SUPPLY
 THERMISTORS PTC ACCORDING TO DIN 44082

Note! All units are in [mm] unless others are stated.

Order Data:

Position	Your pos.	Product name	Amount	Product No	Total
		MTR 15-5/5	1	On request	Price on request