

Qty.	Description
1	MTR 32-14/14 A-F-A-HUUV
	
	Product No.: On request
	Multistage, immersible, self-priming, centrifugal pump for vertical installation in tanks etc. The pump head and base are in cast iron – all other wetted parts are in stainless steel. The pump has the following characteristics:
	<ul style="list-style-type: none"> • Dimensions according to DIN 5440. • Impellers, intermediate chambers and spline shaft are made of Stainless steel. • Mechanical shaft seal according to EN 12756. • Power transmission via sintered metal split coupling.
	A cartridge shaft seal ensures high reliability, safe handling, and easy access and service. The pump is fitted with a 3-phase, fan-cooled asynchronous motor.
	Controls:
	Frequency converter: NONE
	Liquid:
	Pumped liquid: Water
	Liquid temperature range: -10 .. 90 °C
	Selected liquid temperature: 20 °C
	Density: 998.2 kg/m ³
	Technical:
	Pump speed on which pump data are based: 2951 rpm
	Rated flow: 500 l/min
	Rated head: 218.1 m
	Chambers: 14
	Drainage back to tank: N
	Pump orientation: Vertical
	Code for shaft seal: HUUV
	Approvals: CE, EAC
	Curve tolerance: ISO9906:2012 3B
	Materials:
	Pump head: Cast iron EN 1561 EN-GJL-200 ASTM A48-25B
	Impeller: Stainless steel EN 1.4301 AISI 304
	Installation:
	t max amb: 55 °C
	Maximum operating pressure: 25 bar
	Max pressure at stated temp: 25 bar / 90 °C
	Type of connection: DIN
	Size of outlet connection: DN 65
	Immersion depth: 1063 mm
	Pressure rating for connection: PN 40
	Flange size for motor: FF350
	Electrical data:
	Motor standard: IEC
	Motor type: SIEMENS
	IE Efficiency class: IE3

Qty.	Description																																																		
1	<table> <tr> <td>Rated power - P2:</td> <td>30 kW</td> </tr> <tr> <td>Mains frequency:</td> <td>50 Hz</td> </tr> <tr> <td>Suitable for 50/60 Hz:</td> <td>N</td> </tr> <tr> <td>Rated voltage:</td> <td>3 x 380-420D/660-725Y V</td> </tr> <tr> <td>Rated current:</td> <td>53/31 A</td> </tr> <tr> <td>Starting current:</td> <td>700-700 %</td> </tr> <tr> <td>Cos phi - power factor:</td> <td>0.87</td> </tr> <tr> <td>Rated speed:</td> <td>2955 rpm</td> </tr> <tr> <td>Efficiency:</td> <td>IE3 93,3%</td> </tr> <tr> <td>Motor efficiency at full load:</td> <td>93.3-93.3 %</td> </tr> <tr> <td>Motor efficiency at 3/4 load:</td> <td>93.5-93.5 %</td> </tr> <tr> <td>Motor efficiency at 1/2 load:</td> <td>92.9-92.9 %</td> </tr> <tr> <td>Number of poles:</td> <td>2</td> </tr> <tr> <td>Enclosure class (IEC 34-5):</td> <td>IP55</td> </tr> <tr> <td>Insulation class (IEC 85):</td> <td>F</td> </tr> <tr> <td>Motor No:</td> <td>81U15332</td> </tr> <tr> <td colspan="2">Others:</td> </tr> <tr> <td>Terminal box position:</td> <td>6</td> </tr> <tr> <td>Minimum efficiency index, MEI ≥:</td> <td>0.70</td> </tr> <tr> <td>Net weight:</td> <td>277 kg</td> </tr> <tr> <td>Gross weight:</td> <td>328 kg</td> </tr> <tr> <td>Shipping volume:</td> <td>0.801 m³</td> </tr> <tr> <td>Danish VVS No.:</td> <td>386969014</td> </tr> <tr> <td>Country of origin:</td> <td>HU</td> </tr> <tr> <td>Custom tariff no.:</td> <td>84137075</td> </tr> </table>	Rated power - P2:	30 kW	Mains frequency:	50 Hz	Suitable for 50/60 Hz:	N	Rated voltage:	3 x 380-420D/660-725Y V	Rated current:	53/31 A	Starting current:	700-700 %	Cos phi - power factor:	0.87	Rated speed:	2955 rpm	Efficiency:	IE3 93,3%	Motor efficiency at full load:	93.3-93.3 %	Motor efficiency at 3/4 load:	93.5-93.5 %	Motor efficiency at 1/2 load:	92.9-92.9 %	Number of poles:	2	Enclosure class (IEC 34-5):	IP55	Insulation class (IEC 85):	F	Motor No:	81U15332	Others:		Terminal box position:	6	Minimum efficiency index, MEI ≥:	0.70	Net weight:	277 kg	Gross weight:	328 kg	Shipping volume:	0.801 m ³	Danish VVS No.:	386969014	Country of origin:	HU	Custom tariff no.:	84137075
Rated power - P2:	30 kW																																																		
Mains frequency:	50 Hz																																																		
Suitable for 50/60 Hz:	N																																																		
Rated voltage:	3 x 380-420D/660-725Y V																																																		
Rated current:	53/31 A																																																		
Starting current:	700-700 %																																																		
Cos phi - power factor:	0.87																																																		
Rated speed:	2955 rpm																																																		
Efficiency:	IE3 93,3%																																																		
Motor efficiency at full load:	93.3-93.3 %																																																		
Motor efficiency at 3/4 load:	93.5-93.5 %																																																		
Motor efficiency at 1/2 load:	92.9-92.9 %																																																		
Number of poles:	2																																																		
Enclosure class (IEC 34-5):	IP55																																																		
Insulation class (IEC 85):	F																																																		
Motor No:	81U15332																																																		
Others:																																																			
Terminal box position:	6																																																		
Minimum efficiency index, MEI ≥:	0.70																																																		
Net weight:	277 kg																																																		
Gross weight:	328 kg																																																		
Shipping volume:	0.801 m ³																																																		
Danish VVS No.:	386969014																																																		
Country of origin:	HU																																																		
Custom tariff no.:	84137075																																																		

On request MTR 32-14/14 A-F-A-HUUV 50 Hz

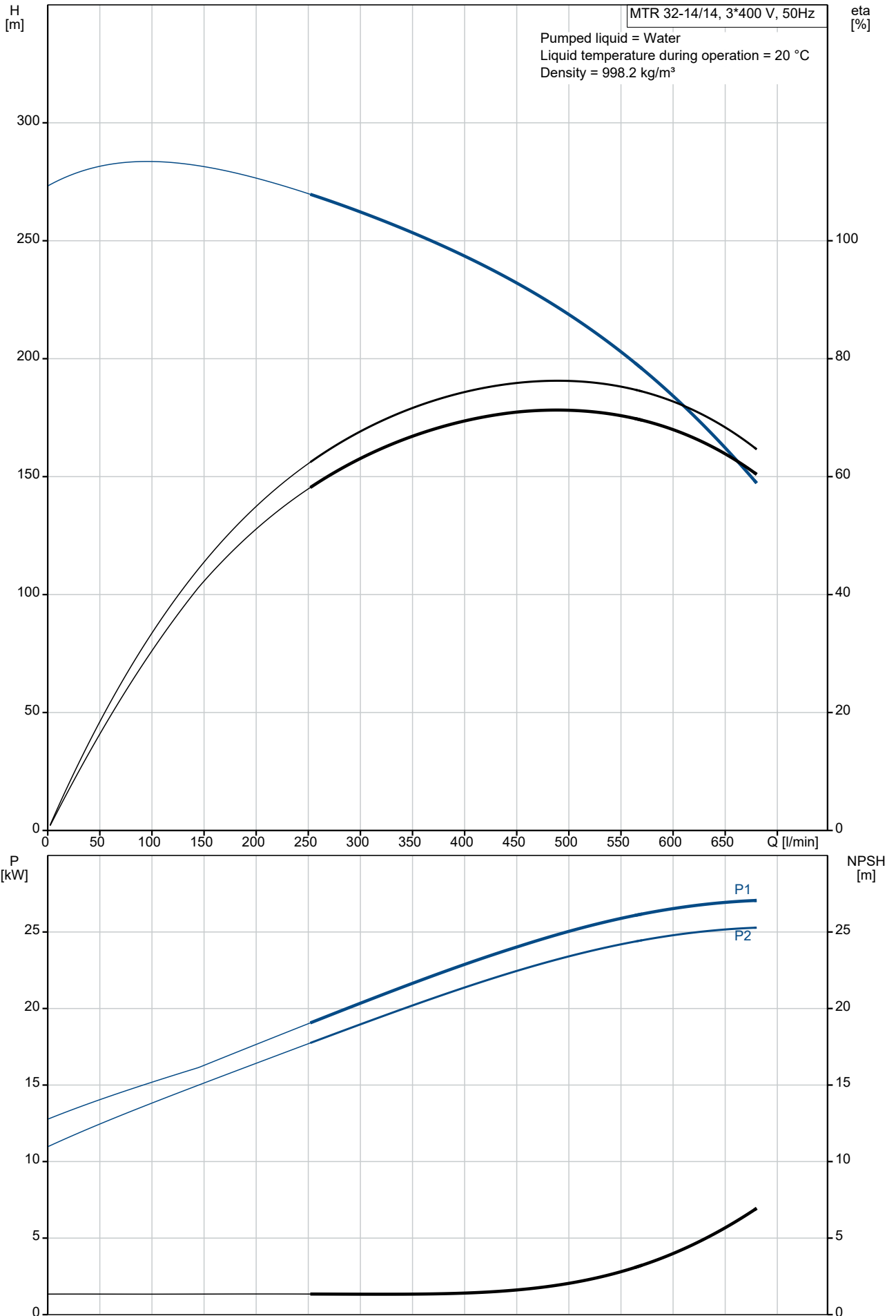

Description	Value
General information:	
Product name:	MTR 32-14/14 A-F-A-HUUU
Product No:	On request
EAN number:	On request
Technical:	
Pump speed on which pump data are based:	2951 rpm
Rated flow:	500 l/min
Rated head:	218.1 m
Chambers:	14
Impellers:	14
Number of reduced-diameter impellers:	0
Drainage back to tank:	N
Pump orientation:	Vertical
Code for shaft seal:	HUUU
Approvals:	CE, EAC
Curve tolerance:	ISO9906:2012 3B
Pump version:	A
Model:	B
Materials:	
Pump head:	Cast iron
Pump head:	EN 1561 EN-GJL-200
Pump head:	ASTM A48-25B
Impeller:	Stainless steel
Impeller:	EN 1.4301
Impeller:	AISI 304
Material code:	A
Installation:	
t max amb:	55 °C
Maximum operating pressure:	25 bar
Max pressure at stated temp:	25 bar / 90 °C
Type of connection:	DIN
Size of outlet connection:	DN 65
Immersion depth:	1063 mm
Pressure rating for connection:	PN 40
Flange size for motor:	FF350
Connect code:	F
Liquid:	
Pumped liquid:	Water
Liquid temperature range:	-10 .. 90 °C
Selected liquid temperature:	20 °C
Density:	998.2 kg/m ³
Electrical data:	
Motor standard:	IEC
Motor type:	SIEMENS
IE Efficiency class:	IE3
Rated power - P2:	30 kW
Mains frequency:	50 Hz
Suitable for 50/60 Hz:	N
Rated voltage:	3 x 380-420D/660-725Y V
Rated current:	53/31 A
Starting current:	700-700 %
Cos phi - power factor:	0.87
Rated speed:	2955 rpm
Efficiency:	IE3 93,3%
Motor efficiency at full load:	93.3-93.3 %
Motor efficiency at 3/4 load:	93.5-93.5 %
Motor efficiency at 1/2 load:	92.9-92.9 %
Number of poles:	2
Enclosure class (IEC 34-5):	IP55
Insulation class (IEC 85):	F
Built-in motor protection:	PTC
Motor No:	81U15332

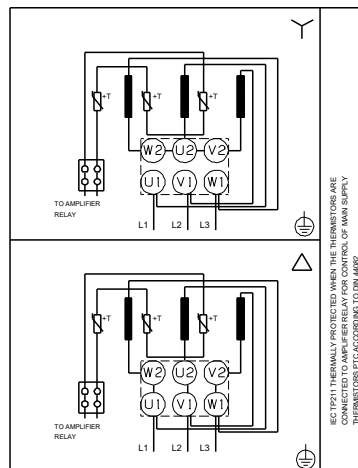
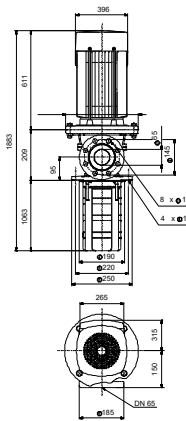
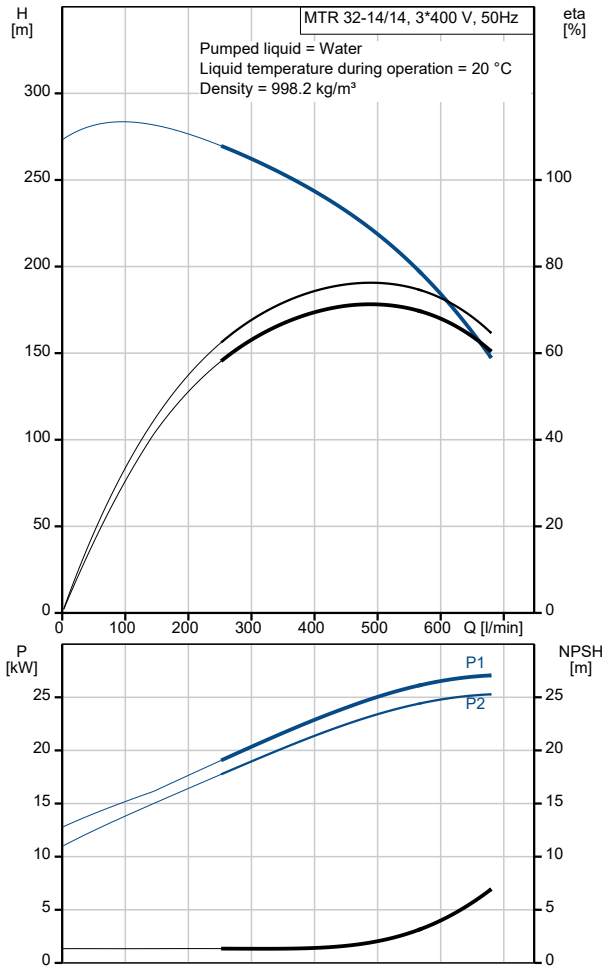

Description	Value
Controls:	
Frequency converter:	NONE
Others:	
Terminal box position:	6
Minimum efficiency index, MEI ≥:	0.70
Net weight:	277 kg
Gross weight:	328 kg
Shipping volume:	0.801 m ³
Danish VVS No.:	386969014
Country of origin:	HU
Custom tariff no.:	84137075

On request MTR 32-14/14 A-F-A-HUUV 50 Hz

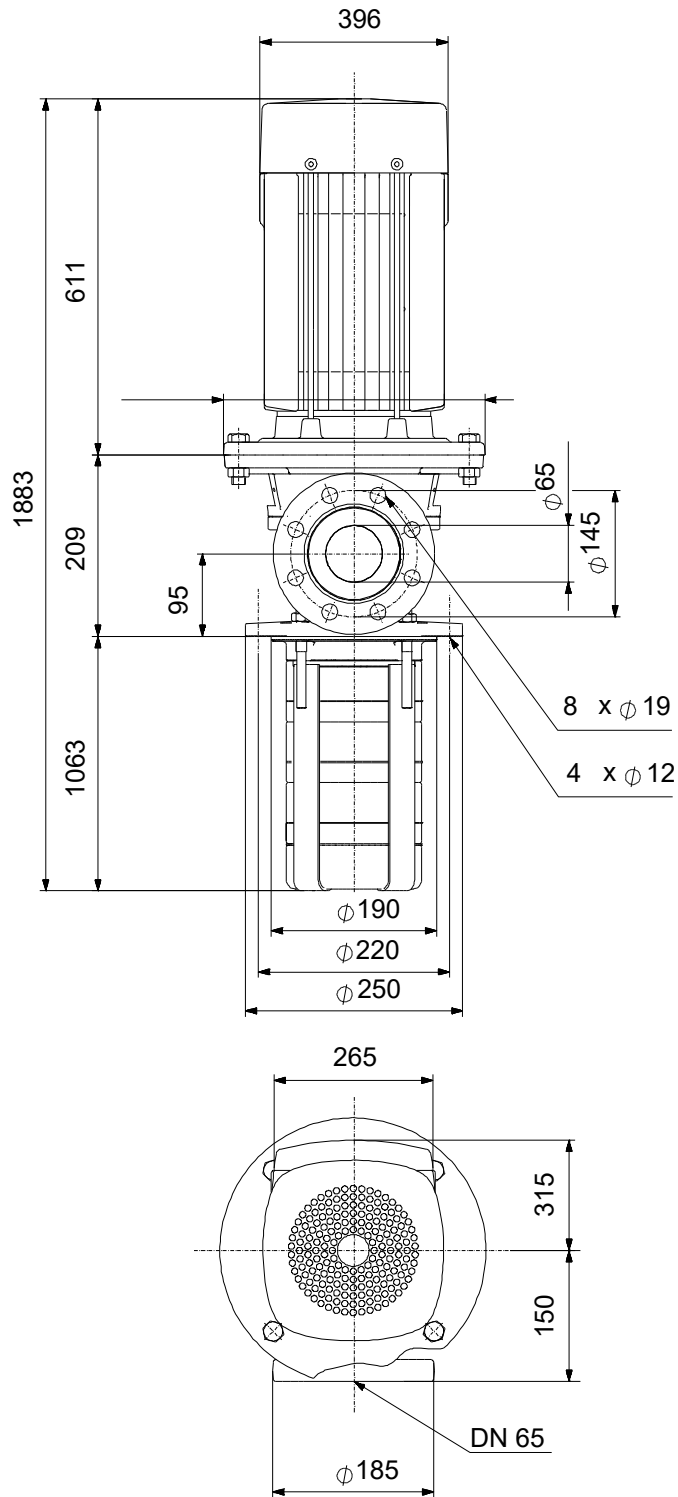

Note! All units are in [mm] unless others are stated.
Disclaimer: This simplified dimensional drawing does not show all details.

On request MTR 32-14/14 A-F-A-HUUV 50 Hz



IEC TP211 THERMALLY PROTECTED WHEN THE THERMISTORS ARE
CONNECTED TO AMPLIFIER RELAY FOR CONTROL OF MAIN SUPPLY
THERMISTORS PTC ACCORDING TO DIN 44082

Note! All units are in [mm] unless others are stated.

