

Qty. Description

1 SLV.80.80 .40.A.EX.4.51D.C



Note! Product picture may differ from actual product

Product No.: [98626464](#)

Non-self-priming, single-stage, centrifugal pump designed for handling wastewater, process water and unscreened raw sewage.

The pump is designed for intermittent and continuous operations in submerged installation. The efficient SuperVortex impeller provides passage of long fibres and solids and is suitable for wastewater with a dry matter content of up to 5 %. A unique stainless-steel clamp assembling system enables quick and easy disassembly of the pump from the motor unit for service and inspection. No special tools are required. Pipework connection is via a DIN flange.

Further product details

The pump is suitable for both temporary and permanent installation either as free-standing on ring stand or on an auto-coupling system.

Pump

The pump housing, motor top and impeller are made of cast iron (EN-GJL-250).

All surfaces of the cast iron parts are protected with cathodolysis coating.

The surface of the cast iron pump parts is afterwards painted with environmental friendly powder coating (type NCS 9000N (black), gloss code 30, thickness 100 µm) which ensures high impact and corrosion protection.

The final pump is assembled from already painted parts which ensures that no rust or scale can be formed in grooves between parts, etc.

The SuperVortex impeller is a symmetrical multivane winglet impeller.

The design ensures a flow entirely outside the impeller providing limited contact between the impeller and the pumped liquid.

This ensures that long fibres, rags and more passes freely through the pump without getting caught and without causing clogging or jamming.



The shaft seal consists of two mechanical seals that ensure a reliable sealing between the pumped liquid and motor. The shaft seals are incorporated in a single-unit cartridge shaft seal system that is easy to replace in the field without use of special tools.

The combination of the primary and secondary seals in a cartridge shaft seal system results in a shorter assembly length compared to conventional shaft seals.

- Primary seal: Silicon carbide/silicon carbide (SiC/SiC)
- Secondary seal: Carbon/Ceramics

The shaft seal is bidirectional, meaning it operates correctly in case of backflow through the pump.

Qty. Description

1



The pump is approved according to CE EN12050-1, ATEX. The pump is approved for installation in explosive atmospheres and holds the following examination certificate:

- ATEX (EU): KEMA08ATEX0125X
- IECEX: IECEX KEM08.0039X

The certificate has been issued according to the ATEX directive (94/9/EC).

For applications involving a risk of explosion, or where otherwise required, the pump is approved with the following explosion protection classifications.

Mains-driven pump, without sensor:

II2 G Ex cd IIB T3, T4 Gb

Mains-driven pump, with sensor:

II2 G Ex cd mb IIB T3, T4 Gb

Frequency converter pump, without sensor:

II2 G Ex cd IIB T3, T4 Gb

Frequency converter pump, with sensor:

II2 G Ex cd mb IIB T3, T4 Gb

Note: Explosion-proof pumps must always be fully submerged.

Motor

The motor is a watertight, totally encapsulated motor supplied with a 10 m power cable. The stainless steel plug is fastened with a union nut. This nut and the O-rings provide sealing against ingress of the liquid.

The plug is polyurethane-embedded, ensuring a watertight and durable seal around the leads of the cable. This prevents the ingress of water into the motor through the cable in case of cable breakage or adverse handling in connection with installation or service.

A compact motor construction with a short shaft reduces vibrations, resulting in an increased efficiency and lifetime of the shaft seal and ball bearings.

The motor features built-in thermal protection to protect the motor against overheating and ensure the reliability.

The pump is equipped with the following sensor(s):

- A digital moisture switch that is fitted in the motor chamber monitors whether water enters the motor chamber. If moisture is detected in the motor chamber, the switch will trip and send a warning to the sensor module.
- An analog sensor that is fitted in the oil chamber monitors whether water enters the pump from the liquid side. It sends a signal if the water content is outside the normal range (warning), or if there is air in the oil chamber (alarm).

The pump is designed for speed-controlled operation to keep the energy consumption at a minimum.

To avoid the risk of sedimentation in the pipes, we recommend that you operate the speed-controlled pump within a speed range of 30 % to 100 % and at a flow rate above 1 m/s.

Controls:

Moisture sensor: with moisture sensors

Water-in-oil sensor: with water-in-oil sensor

Liquid:

Liquid temperature range: 10 .. 40 °C

Density: 998.2 kg/m³

Technical:

Maximum flow: 23.6 l/s

Type of impeller: SUPER VORTEX

Maximum particle size: 80 mm

Primary shaft seal: SIC/SIC

Approvals: CE EN12050-1, ATEX

Curve tolerance: ISO9906:2012 3B2

Qty.	Description
1	<p>Rated speed: 1464 rpm</p> <p>Materials:</p> <p>Pump housing: Cast iron EN 5.1301 EN-GJL-250</p> <p>Impeller: Cast iron EN 5.1301 EN-GJL-250</p> <p>Motor: EN-GJL-250</p> <p>Installation:</p> <p>Range of ambient temperature: 0 .. 40 °C</p> <p>Maximum operating pressure: 6 bar</p> <p>Flange standard: DIN</p> <p>Type of inlet connection: DIN</p> <p>Type of outlet connection: DIN</p> <p>Size of inlet connection: DN 80</p> <p>Size of outlet connection: DN 80</p> <p>Pressure rating: PN 10</p> <p>Maximum installation depth: 20 m</p> <p>Auto-coupling: 96090993</p> <p>Frame range: C</p> <p>Electrical data:</p> <p>Power input - P1: 4.8 kW</p> <p>Rated power - P2: 4 kW</p> <p>Mains frequency: 50 Hz</p> <p>Rated voltage: 3 x 380-415 V</p> <p>Voltage tolerance: +10/-10 %</p> <p>Max starts per. hour: 20</p> <p>Rated current: 9.6 A</p> <p>Starting current: 65 A</p> <p>Cos phi - power factor: 0.72</p> <p>Cos phi - p.f. at 3/4 load: 0.63</p> <p>Cos phi - p.f. at 1/2 load: 0.50</p> <p>Rated speed: 1464 rpm</p> <p>Motor efficiency at full load: 87.4 %</p> <p>Motor efficiency at 3/4 load: 87.1 %</p> <p>Motor efficiency at 1/2 load: 85.0 %</p> <p>Number of poles: 4</p> <p>Start. method: star/delta</p> <p>Enclosure class (IEC 34-5): IP68</p> <p>Insulation class (IEC 85): H</p> <p>Explosion proof: yes</p> <p>Length of power cable: 10 m</p> <p>Cable type: LYNIFLEX</p> <p>Others:</p> <p>Net weight: 134 kg</p> <p>Country of origin: HU</p> <p>Custom tariff no.: 84137021</p>

98626464 SLV.80.80 .40.A.EX.4.51D.C 50 Hz

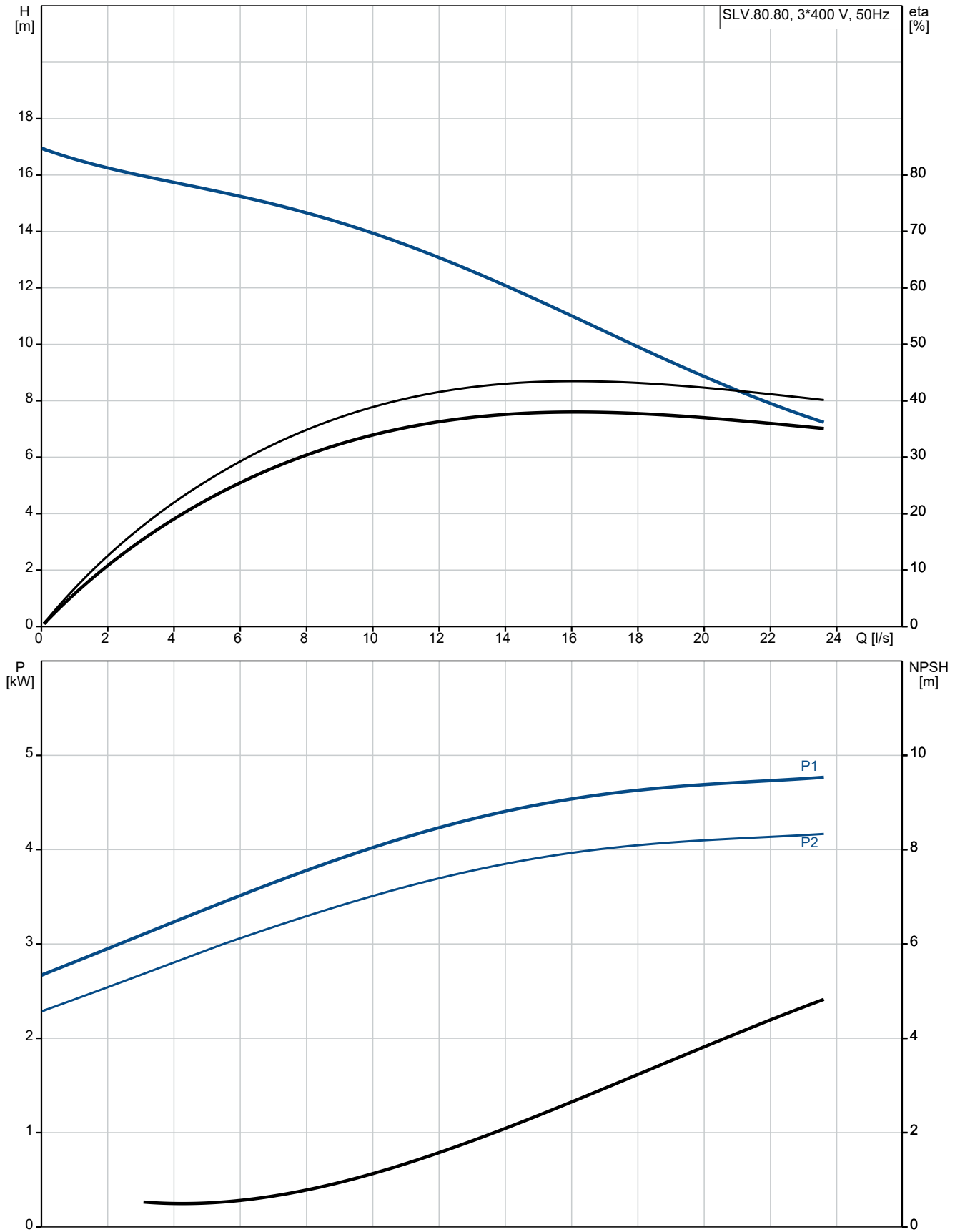

Description	Value
General information:	
Product name:	SLV.80.80 .40.A.EX.4.51D.C
Product No:	98626464
EAN number:	5711498473119
Technical:	
Maximum flow:	23.6 l/s
Maximum head:	18.5 m
Type of impeller:	SUPER VORTEX
Maximum particle size:	80 mm
Primary shaft seal:	SIC/SIC
Approvals:	CE EN12050-1, ATEX
Curve tolerance:	ISO9906:2012 3B2
Cooling jacket:	without cooling jacket
Rated speed:	1464 rpm
Materials:	
Pump housing:	Cast iron
Pump housing:	EN 5.1301 EN-GJL-250
Impeller:	Cast iron
Impeller:	EN 5.1301 EN-GJL-250
Motor:	EN-GJL-250
Installation:	
Range of ambient temperature:	0 .. 40 °C
Maximum operating pressure:	6 bar
Flange standard:	DIN
Type of inlet connection:	DIN
Type of outlet connection:	DIN
Size of inlet connection:	DN 80
Size of outlet connection:	DN 80
Pressure rating:	PN 10
Maximum installation depth:	20 m
Inst dry/wet:	SUBMERGED
Installation:	Vertical
Auto-coupling:	96090993
Frame range:	C
Liquid:	
Liquid temperature range:	10 .. 40 °C
Density:	998.2 kg/m ³
Electrical data:	
Power input - P1:	4.8 kW
Rated power - P2:	4 kW
Mains frequency:	50 Hz
Rated voltage:	3 x 380-415 V
Voltage tolerance:	+10/-10 %
Max starts per. hour:	20
Rated current:	9.6 A
Starting current:	65 A
Cos phi - power factor:	0.72
Cos phi - p.f. at 3/4 load:	0.63
Cos phi - p.f. at 1/2 load:	0.50
Rated speed:	1464 rpm
Motor efficiency at full load:	87.4 %
Motor efficiency at 3/4 load:	87.1 %
Motor efficiency at 1/2 load:	85.0 %
Number of poles:	4
Start. method:	star/delta
Enclosure class (IEC 34-5):	IP68
Insulation class (IEC 85):	H
Explosion proof:	yes

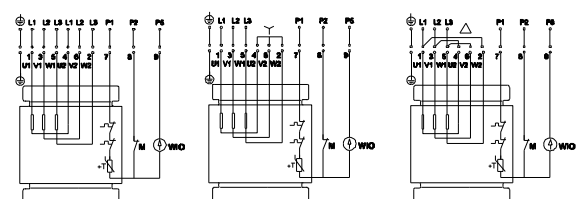
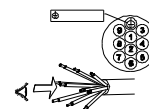
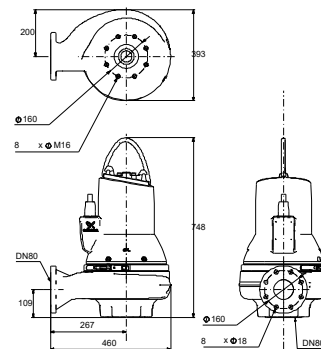
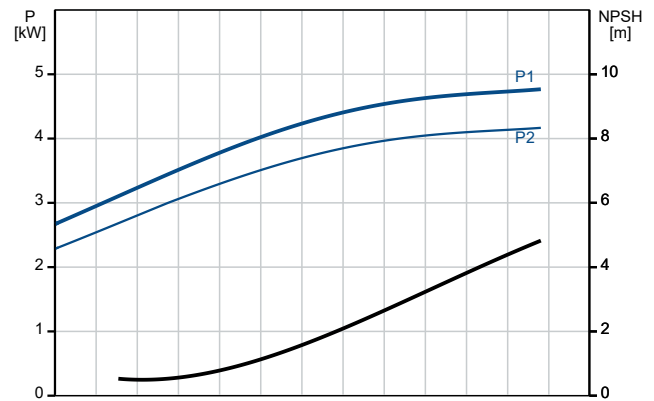
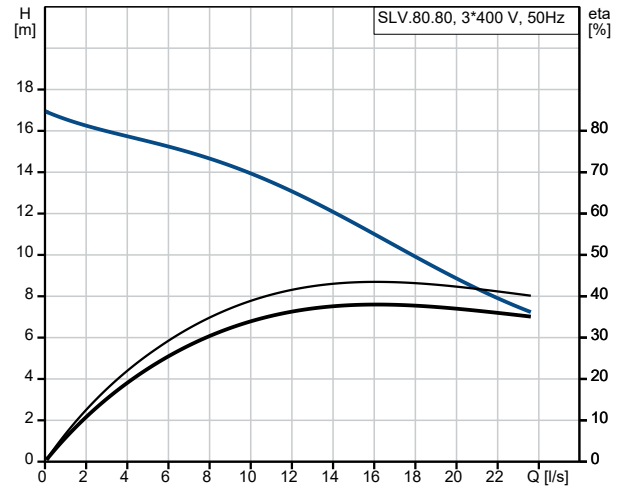



Company name:

Created by:

Phone:

Date:

02/01/2023

Description	Value
Built-in motor protection:	Pt1000
Length of power cable:	10 m
Cable type:	LYNIFLEX
Controls:	
Control box:	not included
Moisture sensor:	with moisture sensors
Water-in-oil sensor:	with water-in-oil sensor
Others:	
Net weight:	134 kg
Country of origin:	HU
Custom tariff no.:	84137021

98626464 SLV.80.80 .40.A.EX.4.51D.C 50 Hz

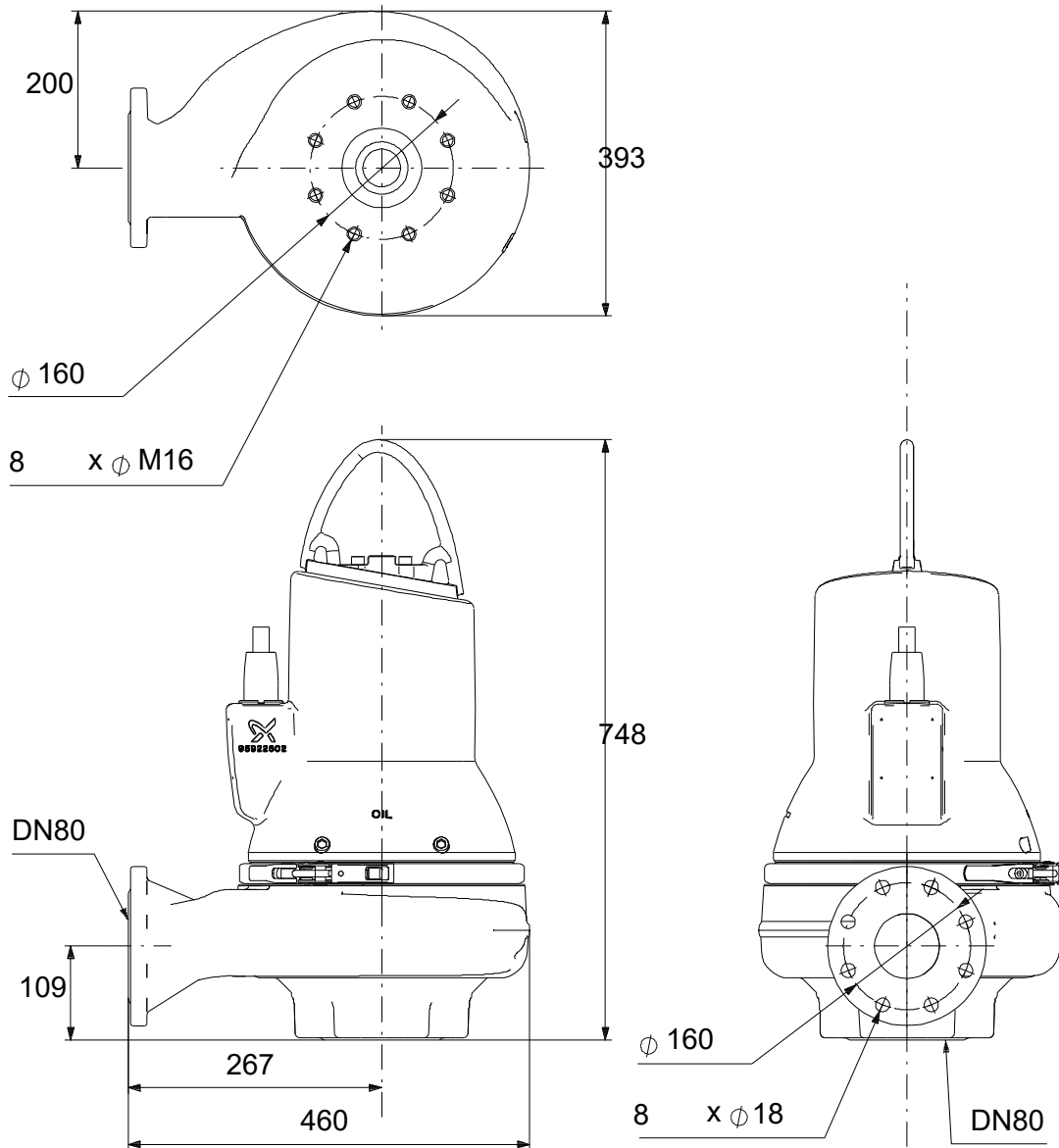

Note! All units are in [mm] unless others are stated.
Disclaimer: This simplified dimensional drawing does not show all details.

98626464 SLV.80.80 .40.A.EX.4.51D.C 50 Hz

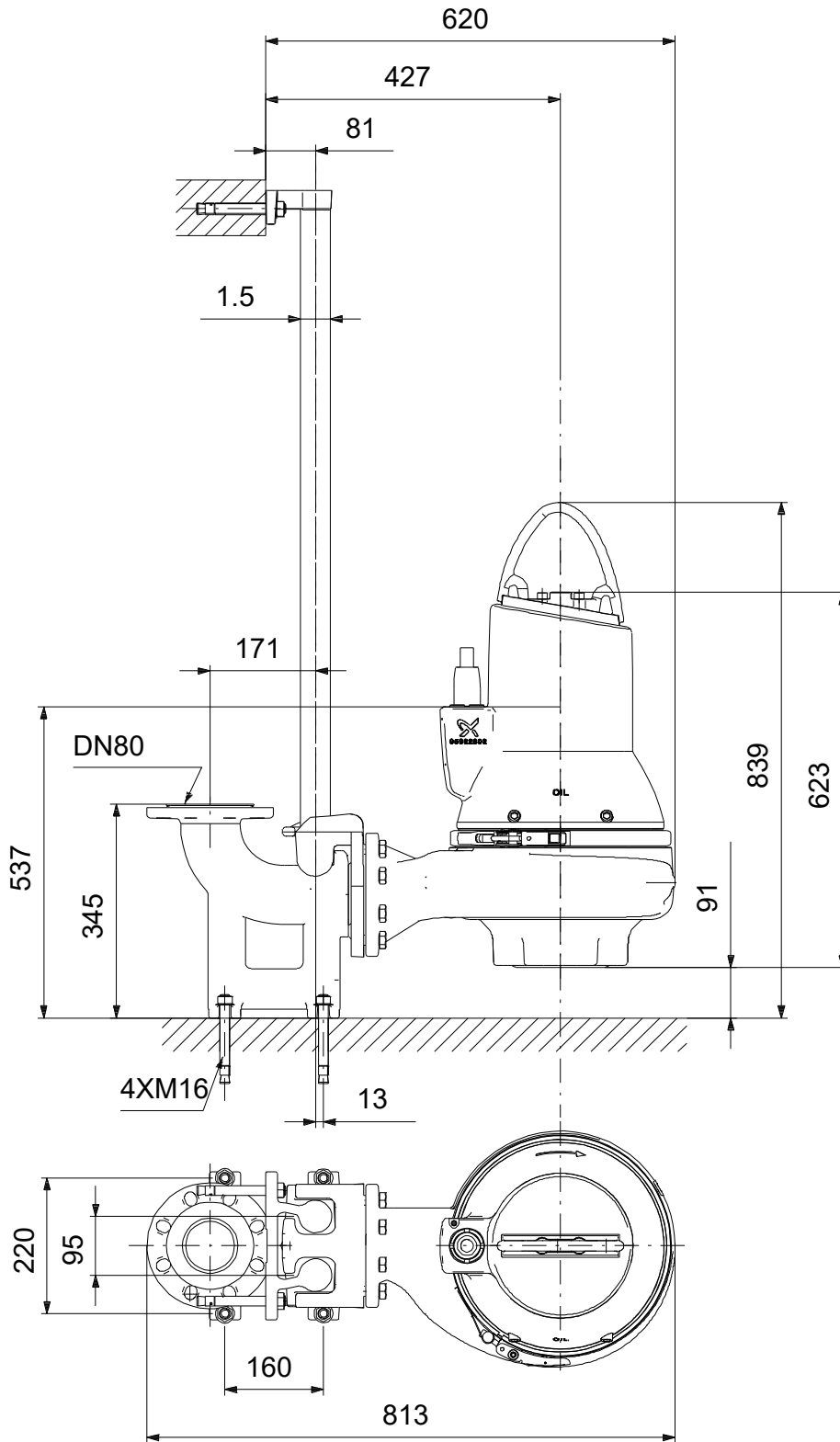

Note! All units are in [mm] unless others are stated.
Disclaimer: This simplified dimensional drawing does not show all details.

98626464 SLV.80.80 .40.A.EX.4.51D.C 50 Hz

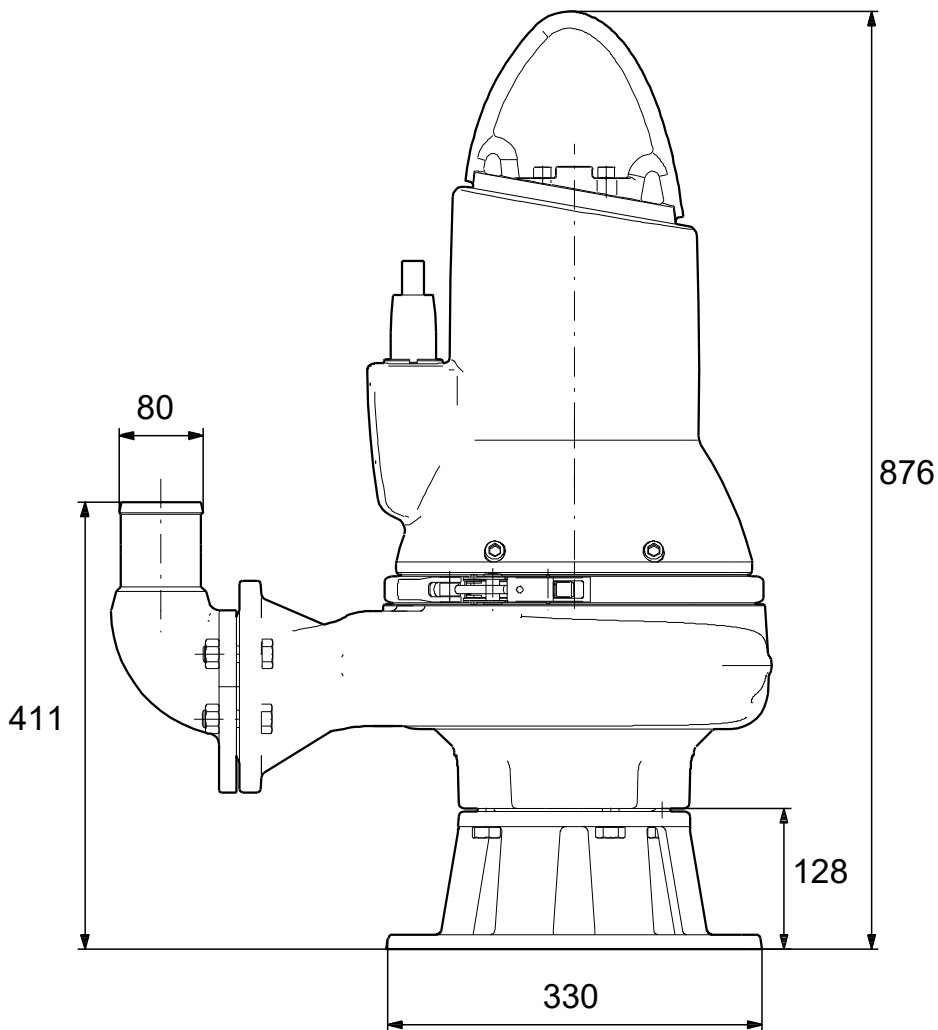
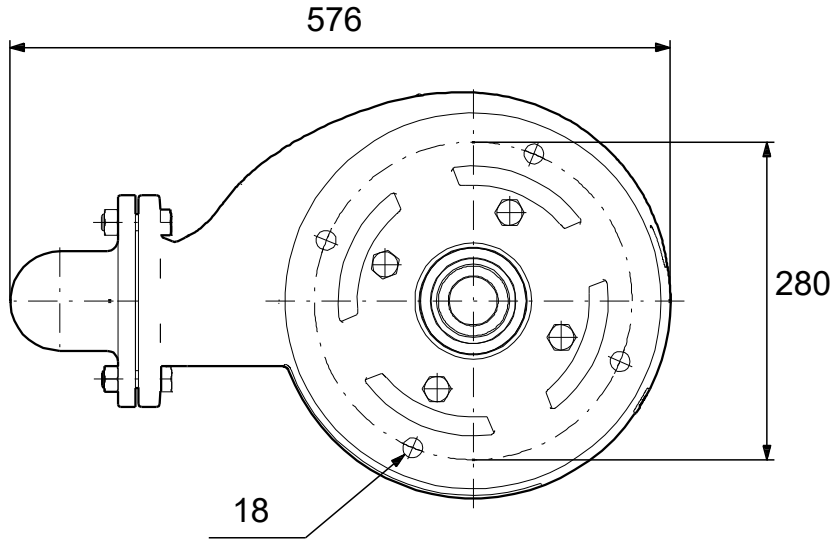

Note! All units are in [mm] unless others are stated.
Disclaimer: This simplified dimensional drawing does not show all details.

98626464 SLV.80.80 .40.A.EX.4.51D.C 50 Hz

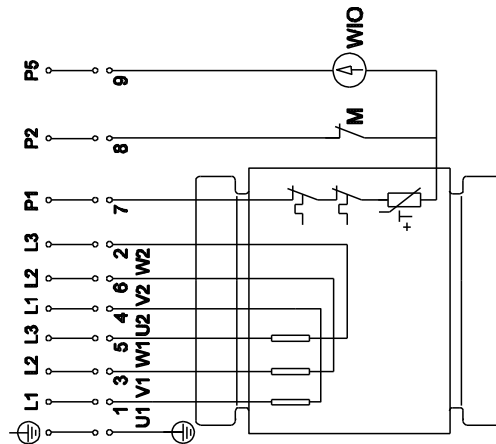
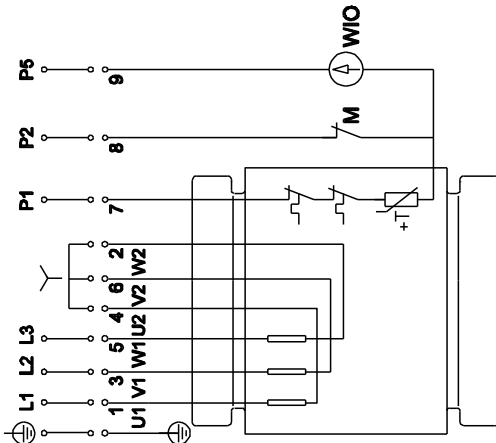

Note! All units are in [mm] unless others are stated.

