

Qty. Description

1 TPE 50-630/2 S-A-F-A-BQQE-OX1



Note! Product picture may differ from actual product

Product No.: [98742806](#)

Single-stage, close-coupled, volute pump with in-line suction and discharge ports of identical diameter.

The pump is of the top-pull-out design, i.e. the power head (motor, pump head and impeller) can be removed for maintenance or service while the pump housing remains in the pipework.

The pump is fitted with an unbalanced rubber bellows seal.

The shaft seal is according to EN 12756. Pipework connection is via PN 16 DIN flanges (EN 1092-2 and ISO 7005-2).

The pump is fitted with a fan-cooled asynchronous motor.

The motor includes a frequency converter and PI controller in the motor terminal box. This enables continuously variable control of the motor speed, which again enables adaptation of the performance to a given requirement.

The pump is fitted with a differential pressure sensor.

The pump is suitable for applications requiring pressure control. The pump is fitted with a differential-pressure transmitter registering the differential pressure across the pump and enabling constant pressure or proportional-pressure control of the pump.

The product's minimum efficiency index (MEI) is greater or equal to 0.70. This is by the Commission Regulation (EU) considered as an indicative benchmark for best-performing water pump available on the market as from 1 January 2013.

A control panel enables setting of required setpoint as well as setting of pump to "Min." or "Max." operation or to "Stop".

The control panel has indicator lights for "Operation" and "Fault".

Communication with the pump is possible by means of the Grundfos GO Remote (accessory).

The remote control enables further settings as well as reading out of a number of parameters such as "Actual value", "Speed", "Power input" and total "Power consumption".

Cast-iron parts have an epoxy-based coating made in a cathodic electro-deposition (CED) process. CED is a high-quality dip-painting process where an electrical field around the products ensures deposition of paint particles as a thin, well-controlled layer on the surface.

Pump

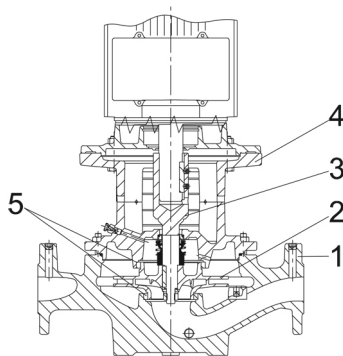

1: Pump housing

2: Impeller

3: Stub shaft

4: Pump head/motor stool

Qty.	Description
1	<p>5: Wear rings</p> <p>The pump housing is provided with a replaceable brass neck ring to reduce the amount of liquid running from the outlet side of the impeller to the inlet side.</p> <p>The impeller is secured to the shaft with a nut.</p> <p>The pump is fitted with an unbalanced rubber bellows seal with torque transmission across the spring and around the bellows. Due to the bellows, the seal does not wear the shaft, and the axial movement is not prevented by deposits on the shaft.</p> <p>Seal faces:</p> <ul style="list-style-type: none"> • Rotating seal ring material: silicon carbide (SiC) • Stationary seat material: silicon carbide (SiC) <p>This material pairing is used where higher corrosion resistance is required. The high hardness of this material pairing offers good resistance against abrasive particles.</p> <p>Secondary seal material: EPDM (ethylene-propylene rubber)</p> <p>EPDM has excellent resistance to hot water. EPDM is not suitable for mineral oils.</p> <p>A circulation of liquid through the duct of the air vent screw ensures lubrication and cooling of the shaft seal.</p> <p>The flanges have tappings for mounting of pressure gauges.</p> <p>The motor stool forms connection between the pump housing and the motor, and is equipped with a manual air vent screw for venting of the pump housing and the shaft seal chamber. The sealing between motor stool and pump housing is an O-ring.</p> <p>The central part of the motor stool is provided with guards for protection against the shaft and coupling. The pump shaft is fastened directly on the motor shaft with key and set screws.</p> <p>The pump is mounted with a base plate.</p> <p>Motor</p> <p>The motor is a totally enclosed, fan-cooled motor with principal dimensions to IEC and DIN standards. Electrical tolerances comply with IEC 60034.</p> <p>The motor is flange-mounted with free-hole flange (FF).</p> <p>Motor-mounting designation in accordance with IEC 60034-7: IM B 5, IM V 1 (Code I) / IM 3001, IM 3011 (Code II).</p> <p>The motor efficiency is classified as IE3 in accordance with IEC 60034-30-1.</p> <p>The motor requires no external motor protection. The motor control unit incorporates protection against slow- and quick-rising temperatures, e.g. constant overload and stalled conditions.</p> <p>The terminal box holds terminals for these connections:</p> <ul style="list-style-type: none"> • pump start/stop input (potential-free contact) • remote setpoint setting via analog signal, 0-10 V, 0(4)-20 mA • 10 V voltage supply for setpoint potentiometer, I_{max} = 5 mA • one analog sensor input, 0-10 V, 0(4)-20 mA; the factory-fitted pressure sensor is connected to this input • 24 V voltage supply for sensor, I_{max} = 40 mA • one digital input • two potential-free fault signal relays with changeover contact, reporting "Fault", "Operation" or "Ready" • RS-485 GENIbus connection • interface for Grundfos CIM fieldbus module. <p>Further product details</p> <p>Cast-iron parts have an epoxy-based coating made in a cathodic electro-deposition (CED) process. CED is a high-quality dip-painting process where an electrical field around the products ensures deposition of paint particles as a thin, well-controlled layer on the surface.</p> <p>Technical data</p> <p>Controls:</p> <p>Frequency converter: Built-in</p> <p>Liquid:</p> <p>Pumped liquid: Water</p> <p>Liquid temperature range: -25 .. 120 °C</p> <p>Selected liquid temperature: 20 °C</p> <p>Density: 998.2 kg/m³</p>

Qty. Description

1	<p>Technical:</p> <p>Pump speed on which pump data are based: 2940 rpm</p> <p>Rated flow: 55.9 m³/h</p> <p>Rated head: 53.9 m</p> <p>Actual impeller diameter: 219 mm</p> <p>Code for shaft seal: BQQE</p> <p>Curve tolerance: ISO9906:2012 3B</p> <p>Materials:</p> <p>Pump housing: Cast iron EN-GJL-250 ASTM class 35</p> <p>Impeller: Cast iron EN-GJL-200 ASTM class 30</p> <p>Installation:</p> <p>Range of ambient temperature: -20 .. 40 °C</p> <p>Maximum operating pressure: 16 bar</p> <p>Max pressure at stated temp: 16 bar / 120 °C</p> <p>Type of connection: DIN</p> <p>Size of connection: DN 50</p> <p>Pressure rating for connection: PN 16</p> <p>Port-to-port length: 440 mm</p> <p>Flange size for motor: FF300</p> <p>Electrical data:</p> <p>Motor type: 160MD</p> <p>IE Efficiency class: IE3</p> <p>Rated power - P2: 15 kW</p> <p>Mains frequency: 50 Hz</p> <p>Rated voltage: 3 x 380-480 V</p> <p>Rated current: 30.0-26.0 A</p> <p>Cos phi - power factor: 0.91-0.86</p> <p>Rated speed: 480-3540 rpm</p> <p>Efficiency: IE3 91,9%</p> <p>Motor efficiency at full load: 91.9 %</p> <p>Number of poles: 2</p> <p>Enclosure class (IEC 34-5): IP55</p> <p>Insulation class (IEC 85): F</p> <p>Motor No: 85901233</p> <p>Others:</p> <p>Minimum efficiency index, MEI ≥: 0.70</p> <p>Net weight: 197 kg</p> <p>Gross weight: 234 kg</p> <p>Shipping volume: 0.56 m³</p> <p>Danish VVS No.: 381913630</p> <p>Finnish LVI No.: 4616386</p> <p>Country of origin: HU</p> <p>Custom tariff no.: 84137051</p>
---	--

98742806 TPE 50-630/2 S-A-F-A-BQQE-OX1 50 Hz

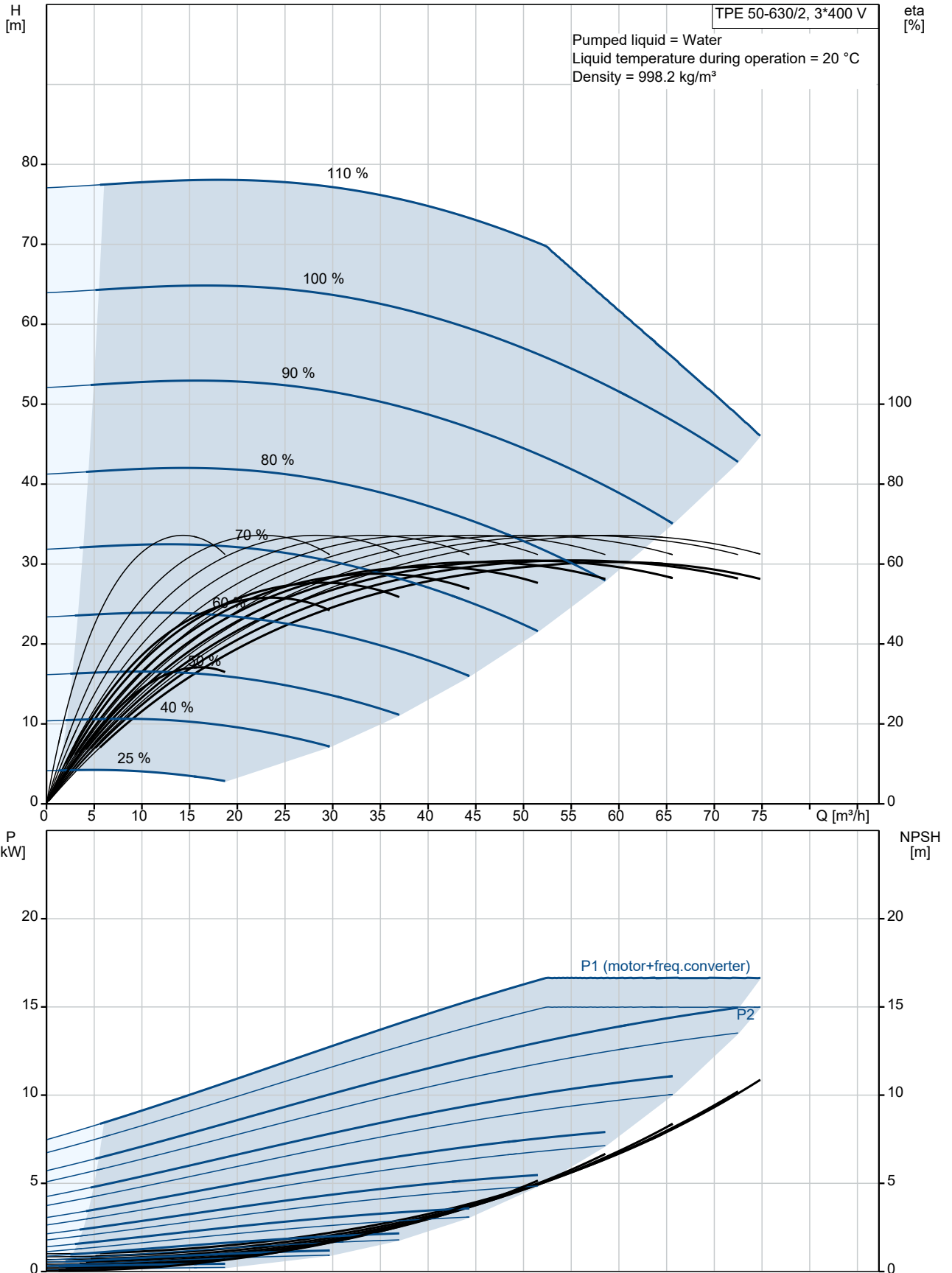

Description	Value
General information:	
Product name:	TPE 50-630/2 S-A-F-A-BQQE-OX1
Product No:	98742806
EAN number:	5712600815278
Technical:	
Pump speed on which pump data are based:	2940 rpm
Rated flow:	55.9 m ³ /h
Rated head:	53.9 m
Maximum head:	630 dm
Actual impeller diameter:	219 mm
Code for shaft seal:	BQQE
Curve tolerance:	ISO9906:2012 3B
Pump version:	A
Materials:	
Pump housing:	Cast iron
Pump housing:	EN-GJL-250
Pump housing:	ASTM class 35
Impeller:	Cast iron
Impeller:	EN-GJL-200
Impeller:	ASTM class 30
Material code:	A
Installation:	
Range of ambient temperature:	-20 .. 40 °C
Maximum operating pressure:	16 bar
Max pressure at stated temp:	16 bar / 120 °C
Type of connection:	DIN
Size of connection:	DN 50
Pressure rating for connection:	PN 16
Port-to-port length:	440 mm
Flange size for motor:	FF300
Connect code:	F
Liquid:	
Pumped liquid:	Water
Liquid temperature range:	-25 .. 120 °C
Selected liquid temperature:	20 °C
Density:	998.2 kg/m ³
Electrical data:	
Motor type:	160MD
IE Efficiency class:	IE3
Rated power - P2:	15 kW
Mains frequency:	50 Hz
Rated voltage:	3 x 380-480 V
Rated current:	30.0-26.0 A
Cos phi - power factor:	0.91-0.86
Rated speed:	480-3540 rpm
Efficiency:	IE3 91,9%
Motor efficiency at full load:	91.9 %
Number of poles:	2
Enclosure class (IEC 34-5):	IP55
Insulation class (IEC 85):	F
Built-in motor protection:	YES
Motor No:	85901233
Controls:	
Control panel:	BS
Function Module:	PUMP I/O
Frequency converter:	Built-in
Others:	

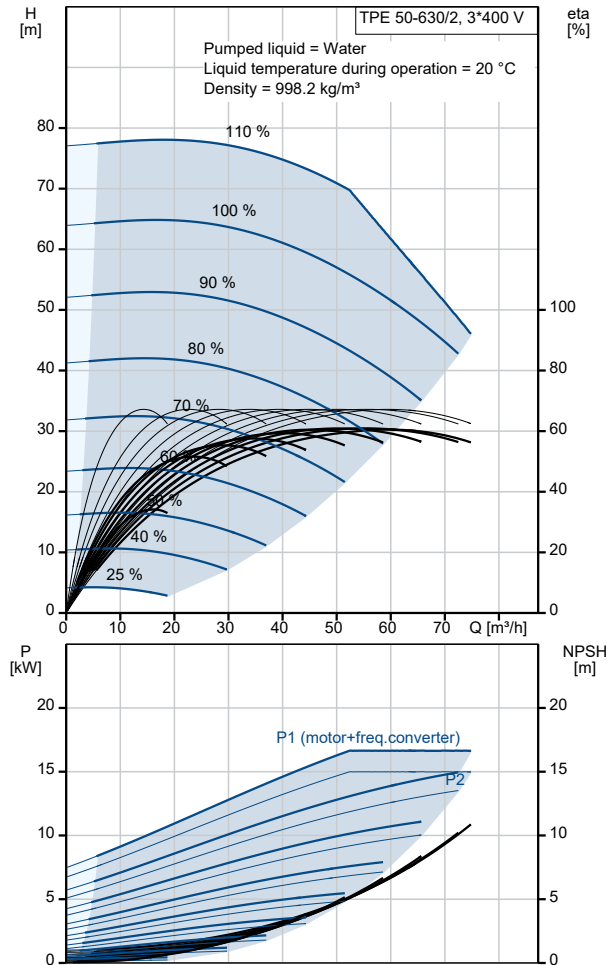



Company name:

Created by:

Phone:

Date:

08/08/2022

Description	Value
Minimum efficiency index, MEI ≥:	0.70
Net weight:	197 kg
Gross weight:	234 kg
Shipping volume:	0.56 m ³
Config. file no:	98779112
Danish VVS No.:	381913630
Finnish LVI No.:	4616386
Country of origin:	HU
Custom tariff no.:	84137051

98742806 TPE 50-630/2 S-A-F-A-BQQE-OX1 50 Hz

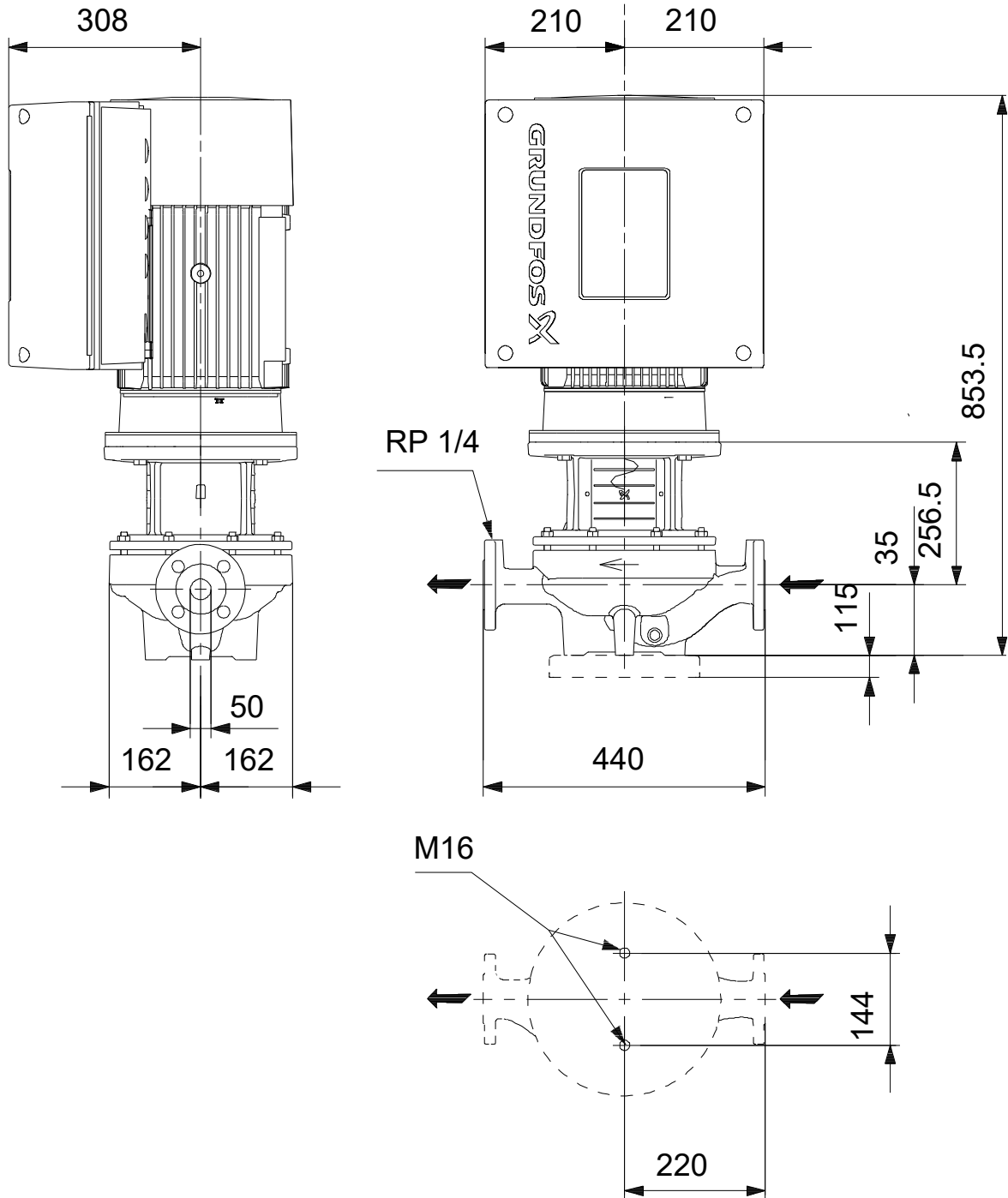

Note! All units are in [mm] unless others are stated.
Disclaimer: This simplified dimensional drawing does not show all details.

98742806 TPE 50-630/2 S-A-F-A-BQQE-OX1 50 Hz

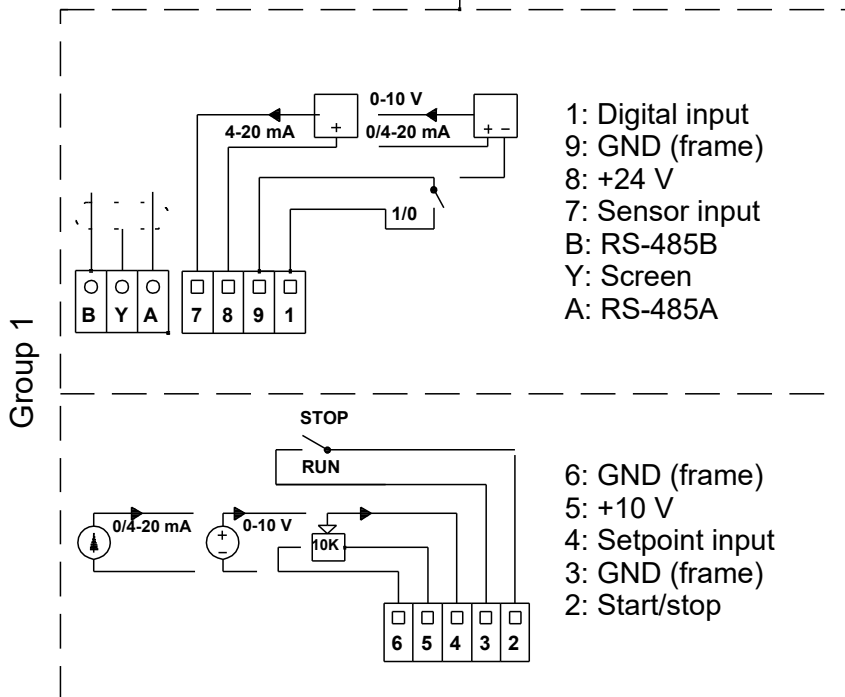
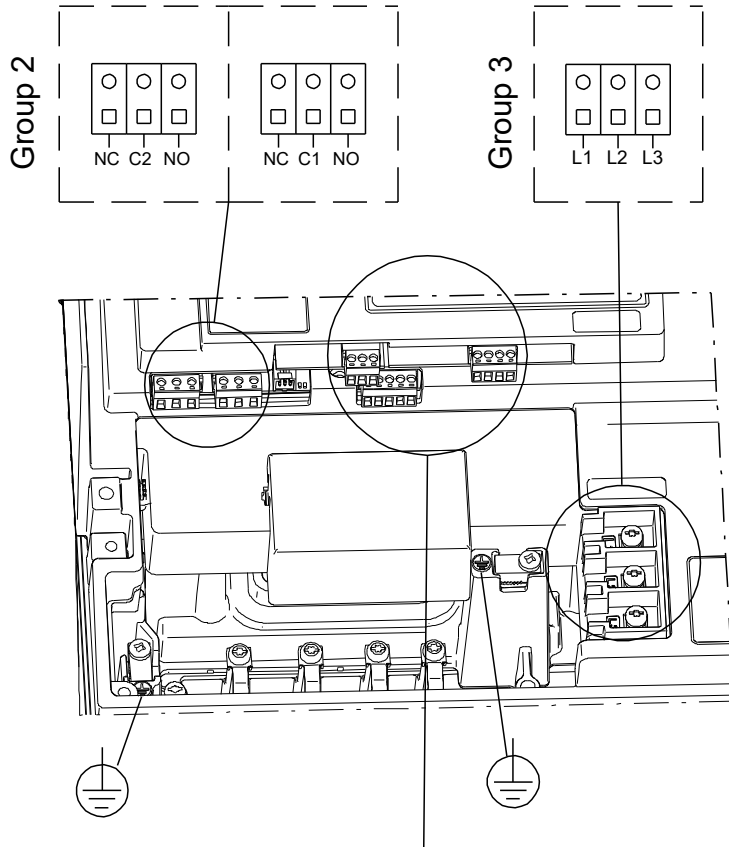

Note! All units are in [mm] unless others are stated.