

Qty.	Description
1	<p data-bbox="204 163 475 185"><b>MTR 8-3/3 A-W-A-HUUV</b></p>  <p data-bbox="204 483 480 506">Product No.: On request</p> <p data-bbox="204 544 1430 618">Multistage, immersible, self-priming, centrifugal pump for vertical installation in tanks etc. The pump head and base are in cast iron – all other wetted parts are in stainless steel. The pump has the following characteristics:</p> <ul data-bbox="240 633 1118 745" style="list-style-type: none"> <li>• Dimensions according to DIN 5440.</li> <li>• Impellers, intermediate chambers and spline shaft are made of Stainless steel.</li> <li>• Mechanical shaft seal according to EN 12756.</li> <li>• Power transmission via sintered metal split coupling.</li> </ul> <p data-bbox="204 752 1430 797">A cartridge shaft seal ensures high reliability, safe handling, and easy access and service. The pump is fitted with a 3-phase, fan-cooled asynchronous motor.</p> <p data-bbox="204 835 300 857">Controls:</p> <p data-bbox="204 864 639 887">Frequency converter: NONE</p> <p data-bbox="204 925 276 947">Liquid:</p> <p data-bbox="204 954 695 1066">Pumped liquid: Water Liquid temperature range: -10 .. 90 °C Selected liquid temperature: 20 °C Density: 998.2 kg/m<sup>3</sup></p> <p data-bbox="204 1104 316 1126">Technical:</p> <p data-bbox="204 1133 818 1395">Pump speed on which pump data are based: 2860 rpm Rated flow: 133 l/min Rated head: 23.1 m Chambers: 3 Drainage back to tank: N Pump orientation: Vertical Code for shaft seal: HUUV Approvals: CE,EAC Curve tolerance: ISO9906:2012 3B</p> <p data-bbox="204 1433 308 1456">Materials:</p> <p data-bbox="204 1462 802 1635">Pump head: Cast iron EN 1561 EN-GJL-200 ASTM A48-25B Impeller: Stainless steel EN 1.4301 AISI 304</p> <p data-bbox="204 1673 323 1695">Installation:</p> <p data-bbox="204 1702 746 1904">t max amb: 60 °C Maximum operating pressure: 25 bar Max pressure at stated temp: 25 bar / 90 °C Type of connection: G internal thread Size of outlet connection: 1 1/4 inch Immersion depth: 250 mm Flange size for motor: FT100</p> <p data-bbox="204 1942 363 1964">Electrical data:</p> <p data-bbox="204 1971 643 2083">Motor standard: IEC Motor type: 80C IE Efficiency class: IE3 Rated power - P2: 1.1 kW</p>

Qty.	Description																																																
1	<table> <tr> <td>Mains frequency:</td> <td>50 Hz</td> </tr> <tr> <td>Suitable for 50/60 Hz:</td> <td>N</td> </tr> <tr> <td>Rated voltage:</td> <td>3 x 220-240D/380-415Y V</td> </tr> <tr> <td>Rated current:</td> <td>4.35/2.50 A</td> </tr> <tr> <td>Starting current:</td> <td>450-500 %</td> </tr> <tr> <td>Cos phi - power factor:</td> <td>0.83-0.76</td> </tr> <tr> <td>Rated speed:</td> <td>2840-2870 rpm</td> </tr> <tr> <td>Efficiency:</td> <td>IE3 82,7%</td> </tr> <tr> <td>Motor efficiency at full load:</td> <td>82.7 %</td> </tr> <tr> <td>Motor efficiency at 3/4 load:</td> <td>84.6 %</td> </tr> <tr> <td>Motor efficiency at 1/2 load:</td> <td>85.4 %</td> </tr> <tr> <td>Number of poles:</td> <td>2</td> </tr> <tr> <td>Enclosure class (IEC 34-5):</td> <td>55 Dust/Jetting</td> </tr> <tr> <td>Insulation class (IEC 85):</td> <td>F</td> </tr> <tr> <td>Motor No:</td> <td>85U05105</td> </tr> <tr> <td colspan="2">Others:</td> </tr> <tr> <td>Terminal box position:</td> <td>6</td> </tr> <tr> <td>Minimum efficiency index, MEI ≥:</td> <td>0.70</td> </tr> <tr> <td>Net weight:</td> <td>21.4 kg</td> </tr> <tr> <td>Gross weight:</td> <td>24.1 kg</td> </tr> <tr> <td>Shipping volume:</td> <td>0.061 m<sup>3</sup></td> </tr> <tr> <td>Danish VVS No.:</td> <td>386965003</td> </tr> <tr> <td>Country of origin:</td> <td>HU</td> </tr> <tr> <td>Custom tariff no.:</td> <td>84137075</td> </tr> </table>	Mains frequency:	50 Hz	Suitable for 50/60 Hz:	N	Rated voltage:	3 x 220-240D/380-415Y V	Rated current:	4.35/2.50 A	Starting current:	450-500 %	Cos phi - power factor:	0.83-0.76	Rated speed:	2840-2870 rpm	Efficiency:	IE3 82,7%	Motor efficiency at full load:	82.7 %	Motor efficiency at 3/4 load:	84.6 %	Motor efficiency at 1/2 load:	85.4 %	Number of poles:	2	Enclosure class (IEC 34-5):	55 Dust/Jetting	Insulation class (IEC 85):	F	Motor No:	85U05105	Others:		Terminal box position:	6	Minimum efficiency index, MEI ≥:	0.70	Net weight:	21.4 kg	Gross weight:	24.1 kg	Shipping volume:	0.061 m <sup>3</sup>	Danish VVS No.:	386965003	Country of origin:	HU	Custom tariff no.:	84137075
Mains frequency:	50 Hz																																																
Suitable for 50/60 Hz:	N																																																
Rated voltage:	3 x 220-240D/380-415Y V																																																
Rated current:	4.35/2.50 A																																																
Starting current:	450-500 %																																																
Cos phi - power factor:	0.83-0.76																																																
Rated speed:	2840-2870 rpm																																																
Efficiency:	IE3 82,7%																																																
Motor efficiency at full load:	82.7 %																																																
Motor efficiency at 3/4 load:	84.6 %																																																
Motor efficiency at 1/2 load:	85.4 %																																																
Number of poles:	2																																																
Enclosure class (IEC 34-5):	55 Dust/Jetting																																																
Insulation class (IEC 85):	F																																																
Motor No:	85U05105																																																
Others:																																																	
Terminal box position:	6																																																
Minimum efficiency index, MEI ≥:	0.70																																																
Net weight:	21.4 kg																																																
Gross weight:	24.1 kg																																																
Shipping volume:	0.061 m <sup>3</sup>																																																
Danish VVS No.:	386965003																																																
Country of origin:	HU																																																
Custom tariff no.:	84137075																																																

# On request MTR 8-3/3 A-W-A-HUUUV 50 Hz

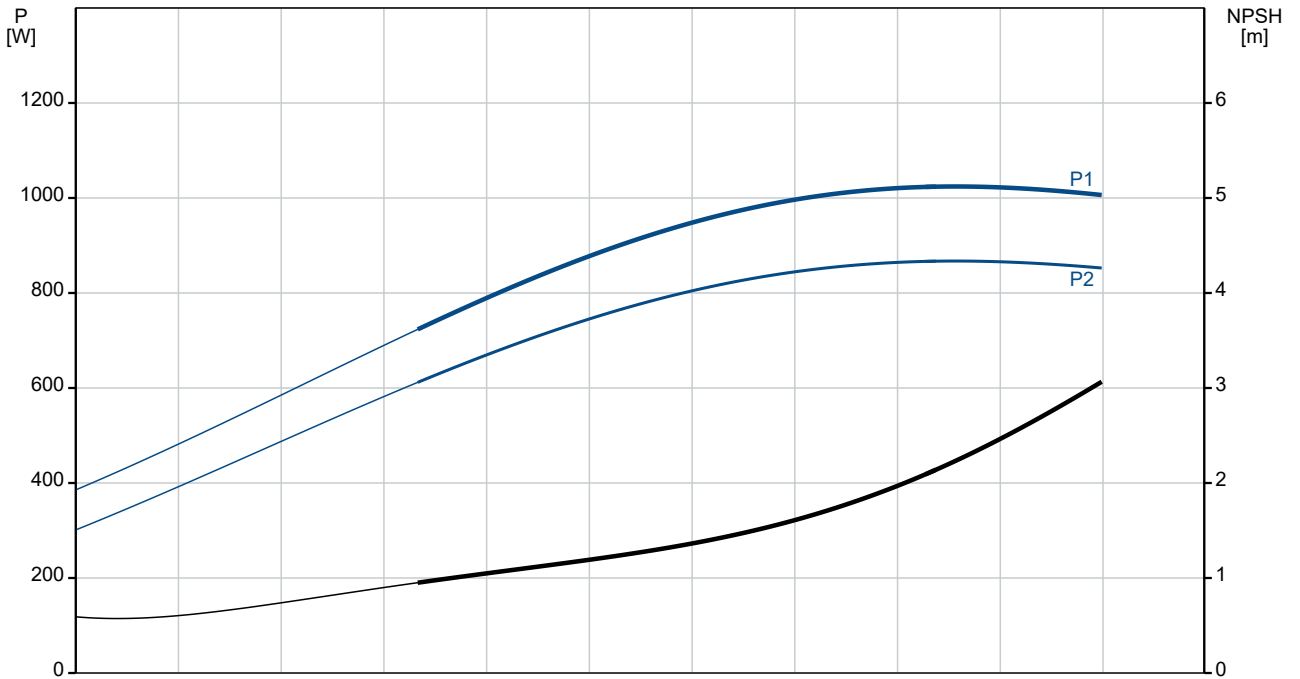
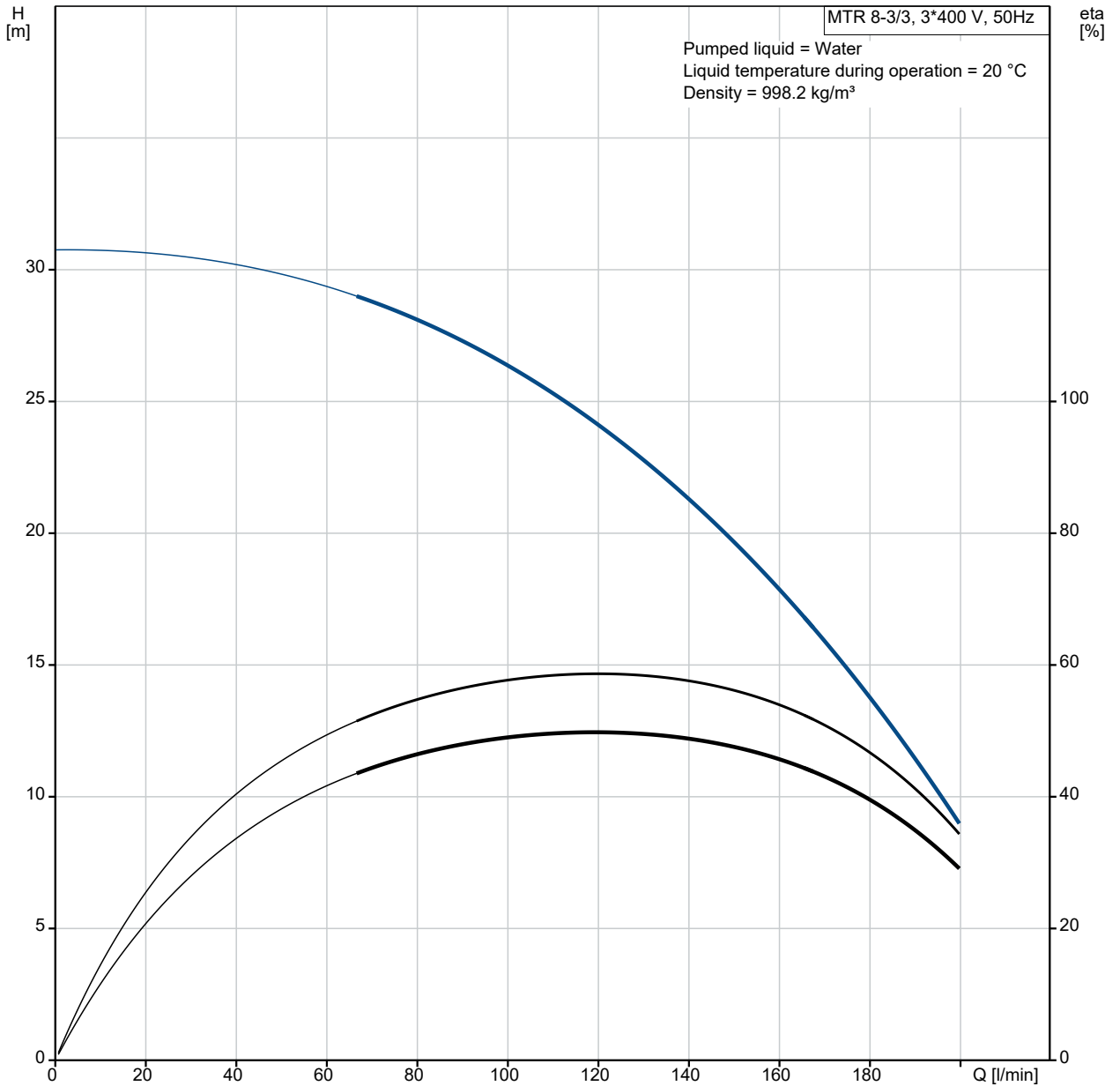

Description	Value
<b>General information:</b>	
Product name:	MTR 8-3/3 A-W-A-HUUV
Product No:	On request
EAN number:	On request
<b>Technical:</b>	
Pump speed on which pump data are based:	2860 rpm
Rated flow:	133 l/min
Rated head:	23.1 m
Chambers:	3
Impellers:	3
Number of reduced-diameter impellers:	0
Drainage back to tank:	N
Pump orientation:	Vertical
Code for shaft seal:	HUUV
Approvals:	CE,EAC
Curve tolerance:	ISO9906:2012 3B
Pump version:	A
Model:	A
<b>Materials:</b>	
Pump head:	Cast iron
Pump head:	EN 1561 EN-GJL-200
Pump head:	ASTM A48-25B
Impeller:	Stainless steel
Impeller:	EN 1.4301
Impeller:	AISI 304
Material code:	A
<b>Installation:</b>	
t max amb:	60 °C
Maximum operating pressure:	25 bar
Max pressure at stated temp:	25 bar / 90 °C
Type of connection:	G internal thread
Size of outlet connection:	1 1/4 inch
Immersion depth:	250 mm
Flange size for motor:	FT100
Connect code:	W
<b>Liquid:</b>	
Pumped liquid:	Water
Liquid temperature range:	-10 .. 90 °C
Selected liquid temperature:	20 °C
Density:	998.2 kg/m <sup>3</sup>
<b>Electrical data:</b>	
Motor standard:	IEC
Motor type:	80C
IE Efficiency class:	IE3
Rated power - P2:	1.1 kW
Mains frequency:	50 Hz
Suitable for 50/60 Hz:	N
Rated voltage:	3 x 220-240D/380-415Y V
Rated current:	4.35/2.50 A
Starting current:	450-500 %
Cos phi - power factor:	0.83-0.76
Rated speed:	2840-2870 rpm
Efficiency:	IE3 82,7%
Motor efficiency at full load:	82.7 %
Motor efficiency at 3/4 load:	84.6 %
Motor efficiency at 1/2 load:	85.4 %
Number of poles:	2
Enclosure class (IEC 34-5):	55 Dust/Jetting
Insulation class (IEC 85):	F
Built-in motor protection:	NONE
Motor No:	85U05105
<b>Controls:</b>	

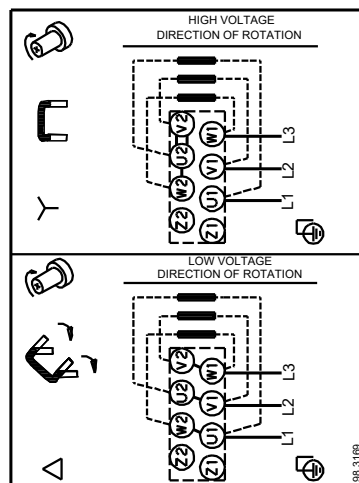
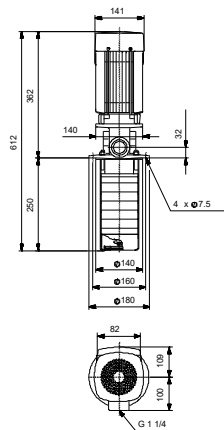
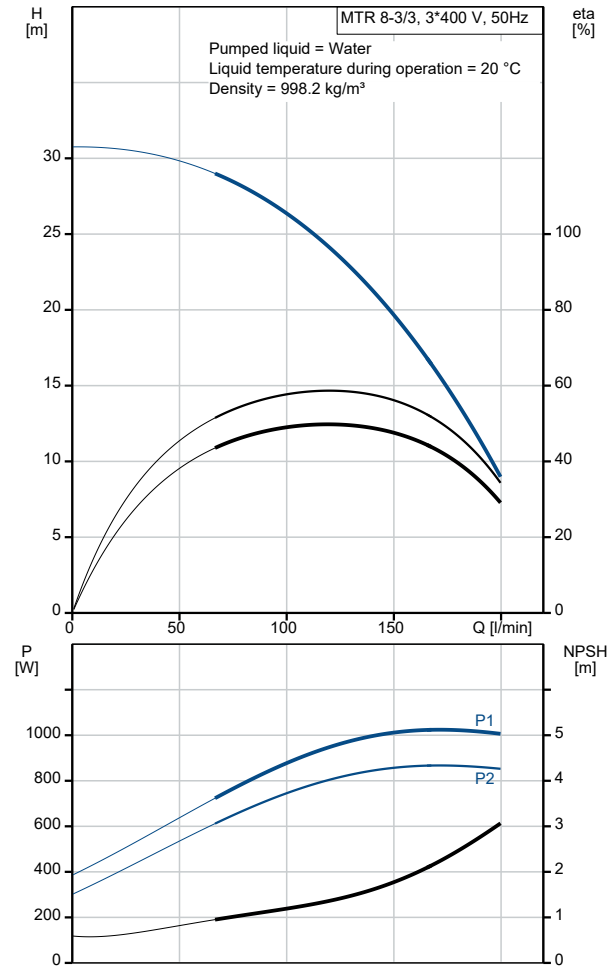

Description	Value
Frequency converter:	NONE
<b>Others:</b>	
Terminal box position:	6
Minimum efficiency index, MEI ≥:	0.70
Net weight:	21.4 kg
Gross weight:	24.1 kg
Shipping volume:	0.061 m <sup>3</sup>
Danish VVS No.:	386965003
Country of origin:	HU
Custom tariff no.:	84137075

**On request MTR 8-3/3 A-W-A-HUUV 50 Hz**

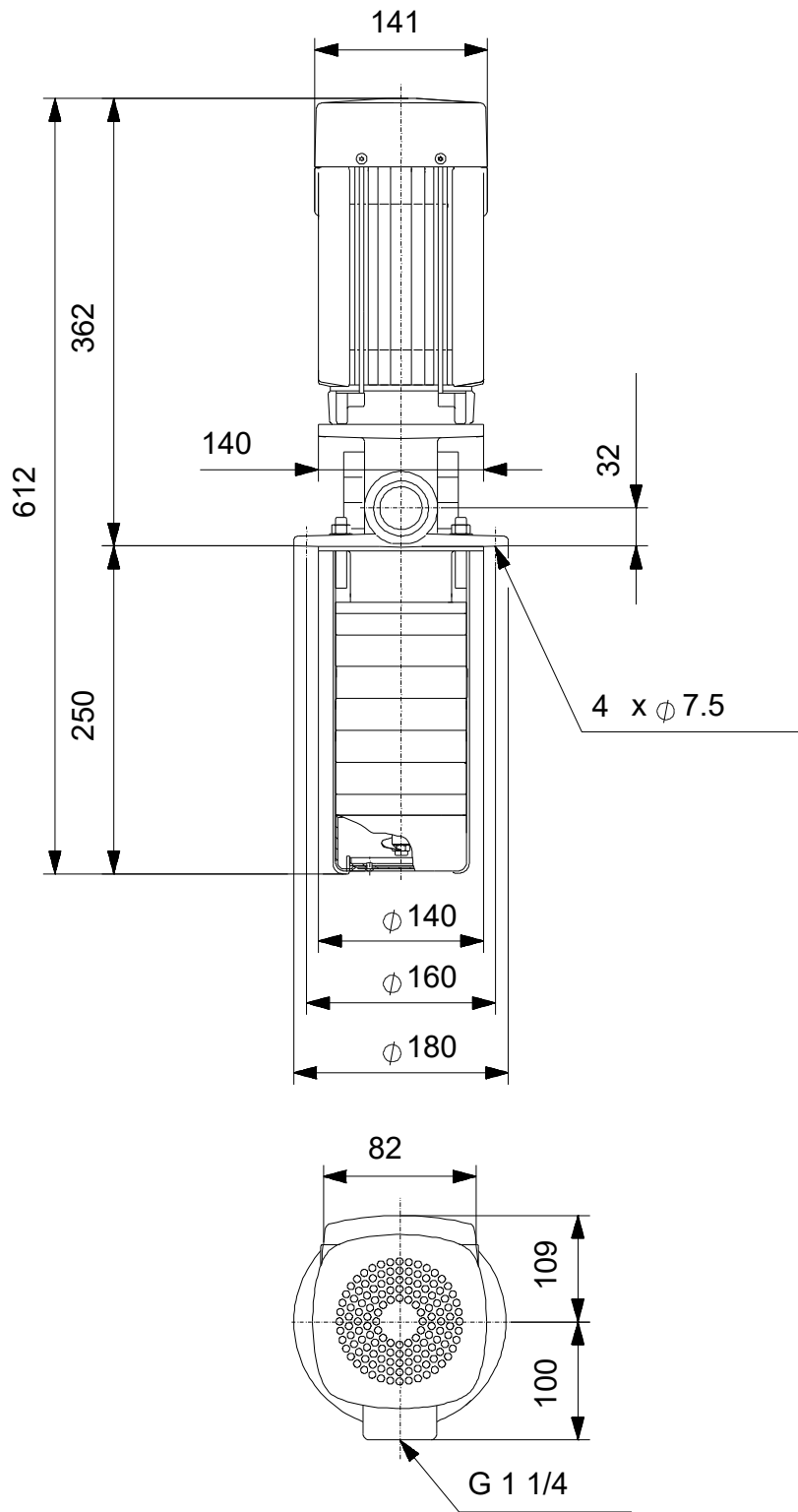

Note! All units are in [mm] unless others are stated.  
Disclaimer: This simplified dimensional drawing does not show all details.

On request MTR 8-3/3 A-W-A-HUUV 50 Hz



98.3169

Note! All units are in [mm] unless others are stated.

