

Qty. Description

1 MTR 8-12/12 A-W-A-HUUV



Product No.: [98825708](#)

Multistage, immersible, self-priming, centrifugal pump for vertical installation in tanks etc. The pump head and base are in cast iron – all other wetted parts are in stainless steel.

The pump has the following characteristics TEST:

- Dimensions according to DIN 5440.
- Impellers, intermediate chambers and spline shaft are made of Stainless steel.
- Mechanical shaft seal according to EN 12756.
- Power transmission via sintered metal split coupling.

A cartridge shaft seal ensures high reliability, safe handling, and easy access and service. The pump is fitted with a 3-phase, fan-cooled asynchronous motor.

Controls:

Frequency converter: NONE

Liquid:

Pumped liquid: Water
 Liquid temperature range: -10 .. 90 °C
 Selected liquid temperature: 20 °C
 Density: 998.2 kg/m³

Technical:

Pump speed on which pump data are based: 2930 rpm
 Rated flow: 133 l/min
 Rated head: 99.4 m
 Chambers: 12
 Drainage back to tank: N
 Pump orientation: Vertical
 Code for shaft seal: HUUV
 Approvals: CE,EAC
 Curve tolerance: ISO9906:2012 3B

Materials:

Pump head: Cast iron
 EN 1561 EN-GJL-200
 ASTM A48-25B
 Impeller: Stainless steel
 EN 1.4301
 AISI 304

Installation:

t max amb: 60 °C
 Maximum operating pressure: 25 bar
 Max pressure at stated temp: 25 bar / 90 °C
 Type of connection: G internal thread

Qty.	Description
------	-------------

1	<p>Size of outlet connection: 1 1/4 inch Immersion depth: 493 mm Flange size for motor: FT130</p> <p>Electrical data: Motor standard: IEC Motor type: 112MC IE Efficiency class: IE3 Rated power - P2: 4 kW Mains frequency: 50 Hz Suitable for 50/60 Hz: N Rated voltage: 3 x 380-415D V Rated current: 7.9 A Starting current: 1000-1110 % Cos phi - power factor: 0.87-0.87 Rated speed: 2920-2940 rpm Efficiency: IE3 88,1% Motor efficiency at full load: 88.1 % Motor efficiency at 3/4 load: 88.6 % Motor efficiency at 1/2 load: 85.2 % Number of poles: 2 Enclosure class (IEC 34-5): 55 Dust/Jetting Insulation class (IEC 85): F Motor No: 85U15413</p> <p>Others: Terminal box position: 6 Minimum efficiency index, MEI ≥: 0.70 Net weight: 48.6 kg Gross weight: 52.6 kg Shipping volume: 0.097 m³ Danish VVS No.: 386965012</p>
---	--

98825708 MTR 8-12/12 A-W-A-HUUV 50 Hz

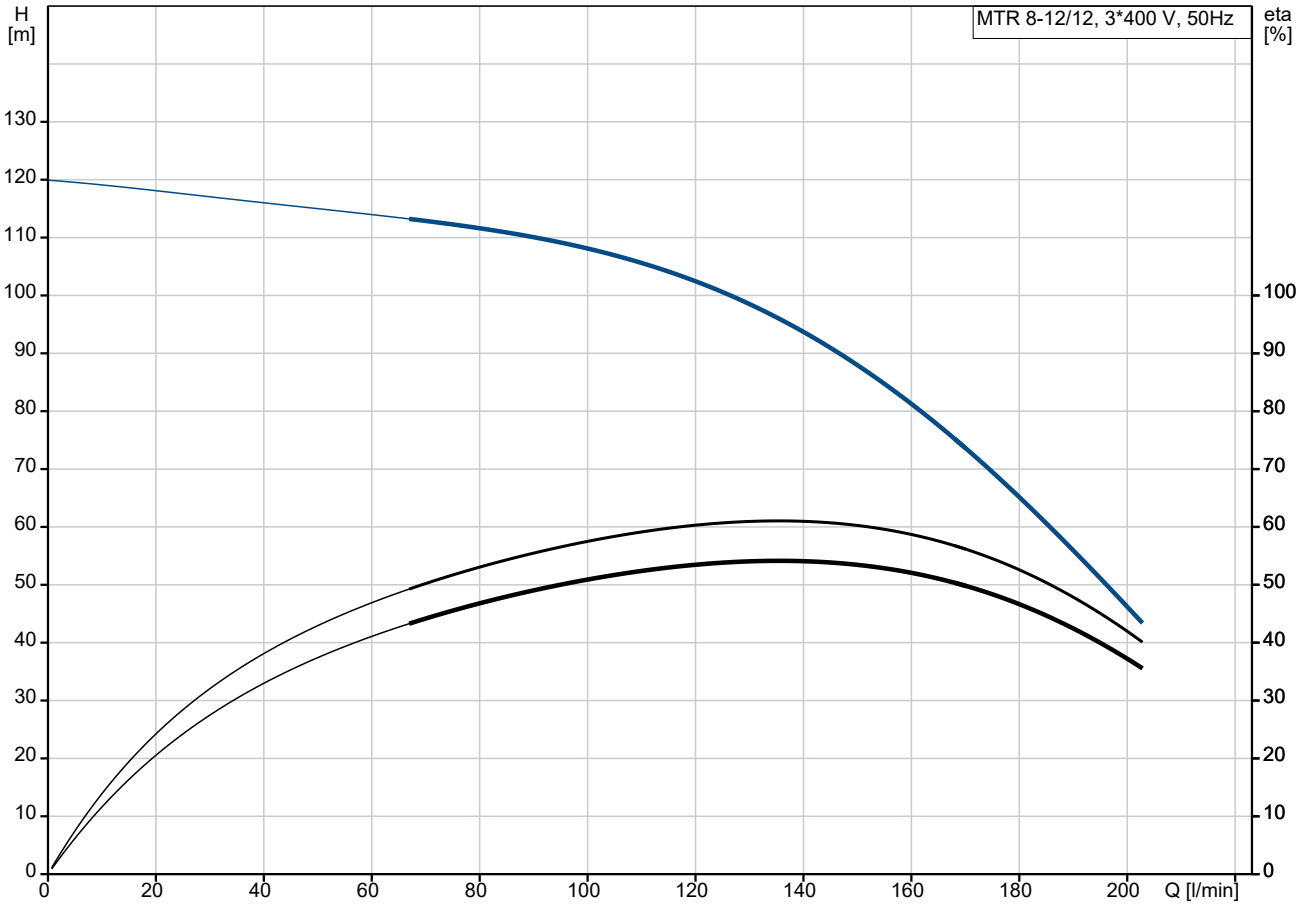

Pumped liquid = Water
Liquid temperature during operation = 20 °C
Density = 998.2 kg/m³

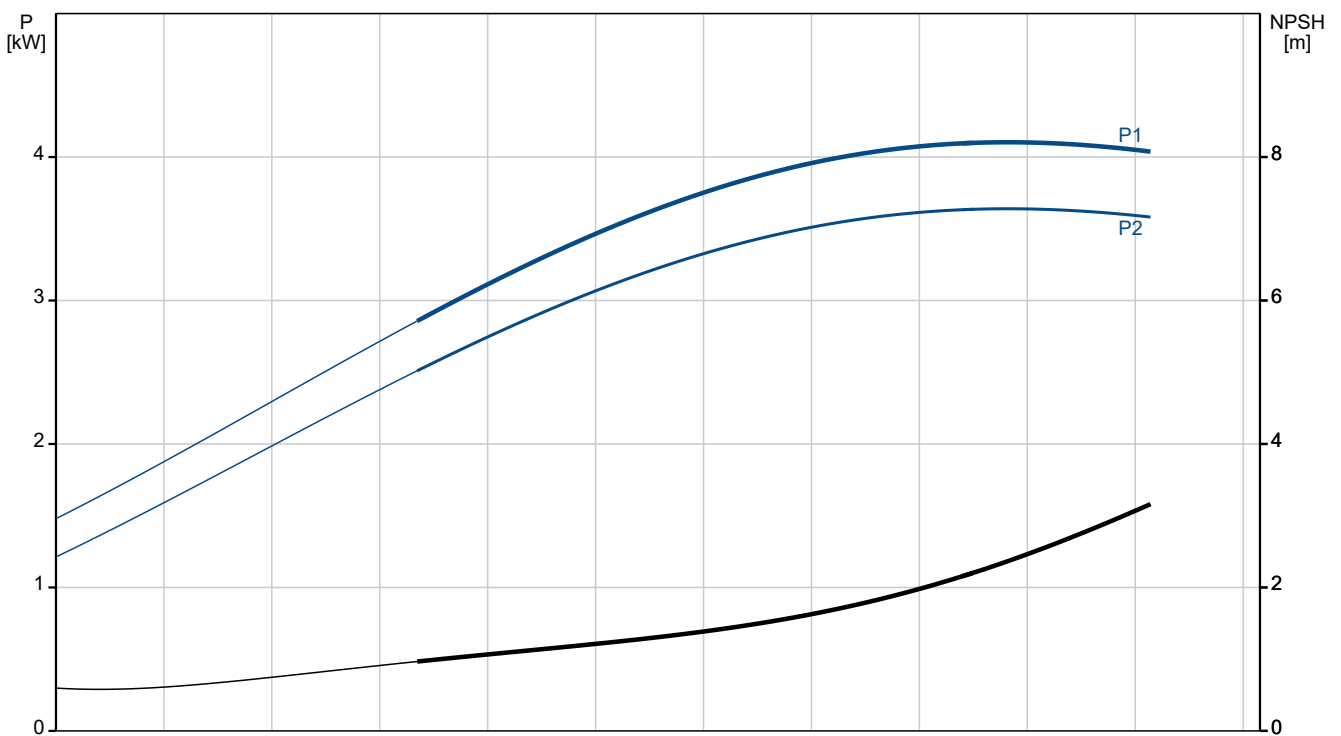

Description	Value
General information:	
Product name:	MTR 8-12/12 A-W-A-HUUV
Product No:	98825708
EAN number:	5712601939775
Technical:	
Pump speed on which pump data are based:	2930 rpm
Rated flow:	133 l/min
Rated head:	99.4 m
Chambers:	12
Impellers:	12
Number of reduced-diameter impellers:	0
Drainage back to tank:	N
Pump orientation:	Vertical
Code for shaft seal:	HUUV
Approvals:	CE,EAC
Curve tolerance:	ISO9906:2012 3B
Pump version:	A
Model:	A
Materials:	
Pump head:	Cast iron
Pump head:	EN 1561 EN-GJL-200
Pump head:	ASTM A48-25B
Impeller:	Stainless steel
Impeller:	EN 1.4301
Impeller:	AISI 304
Material code:	A
Installation:	
t max amb:	60 °C
Maximum operating pressure:	25 bar
Max pressure at stated temp:	25 bar / 90 °C
Type of connection:	G internal thread
Size of outlet connection:	1 1/4 inch
Immersion depth:	493 mm
Flange size for motor:	FT130
Connect code:	W </td
Liquid:	
Pumped liquid:	Water
Liquid temperature range:	-10 .. 90 °C
Selected liquid temperature:	20 °C
Density:	998.2 kg/m ³
Electrical data:	
Motor standard:	IEC
Motor type:	112MC
IE Efficiency class:	IE3
Rated power - P2:	4 kW
Mains frequency:	50 Hz
Suitable for 50/60 Hz:	N
Rated voltage:	3 x 380-415D V
Rated current:	7.9 A
Starting current:	1000-1110 %
Cos phi - power factor:	0.87-0.87
Rated speed:	2920-2940 rpm
Efficiency:	IE3 88,1%
Motor efficiency at full load:	88.1 %
Motor efficiency at 3/4 load:	88.6 %
Motor efficiency at 1/2 load:	85.2 %
Number of poles:	2

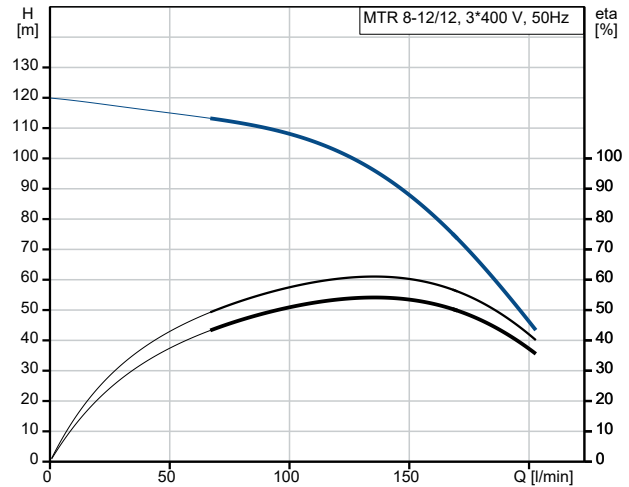

Pumped liquid = Water
Liquid temperature during operation = 20 °C
Density = 998.2 kg/m³

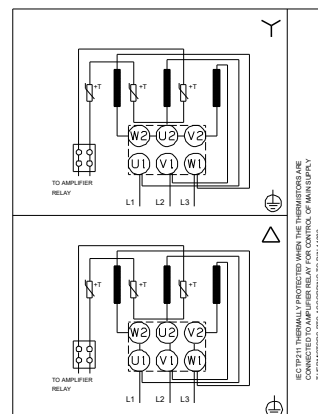
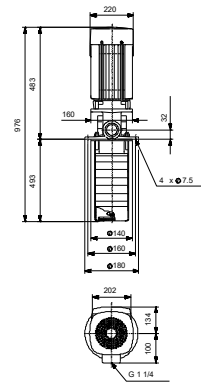
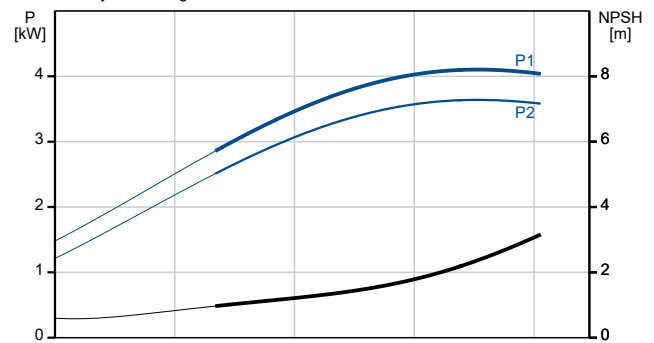

IEC 60747-11 THERMAL PROTECTED WITH THE THERMOSTATIC LINE
CONNECTED TO AMPLIFIER RELAY FOR CONTROL OF MAXIMUM FLY
THERMOSTORE PTC ACCORDING TO DIN 4482



Company name:

Created by:

Phone:

Date:

30/12/2022

Description	Value
Enclosure class (IEC 34-5):	55 Dust/Jetting
Insulation class (IEC 85):	F
Built-in motor protection:	PTC
Motor No:	85U15413
Controls:	
Frequency converter:	NONE
Others:	
Terminal box position:	6
Minimum efficiency index, MEI \geq :	0.70
Net weight:	48.6 kg
Gross weight:	52.6 kg
Shipping volume:	0.097 m ³
Danish VVS No.:	386965012

98825708 MTR 8-12/12 A-W-A-HUUV 50 Hz

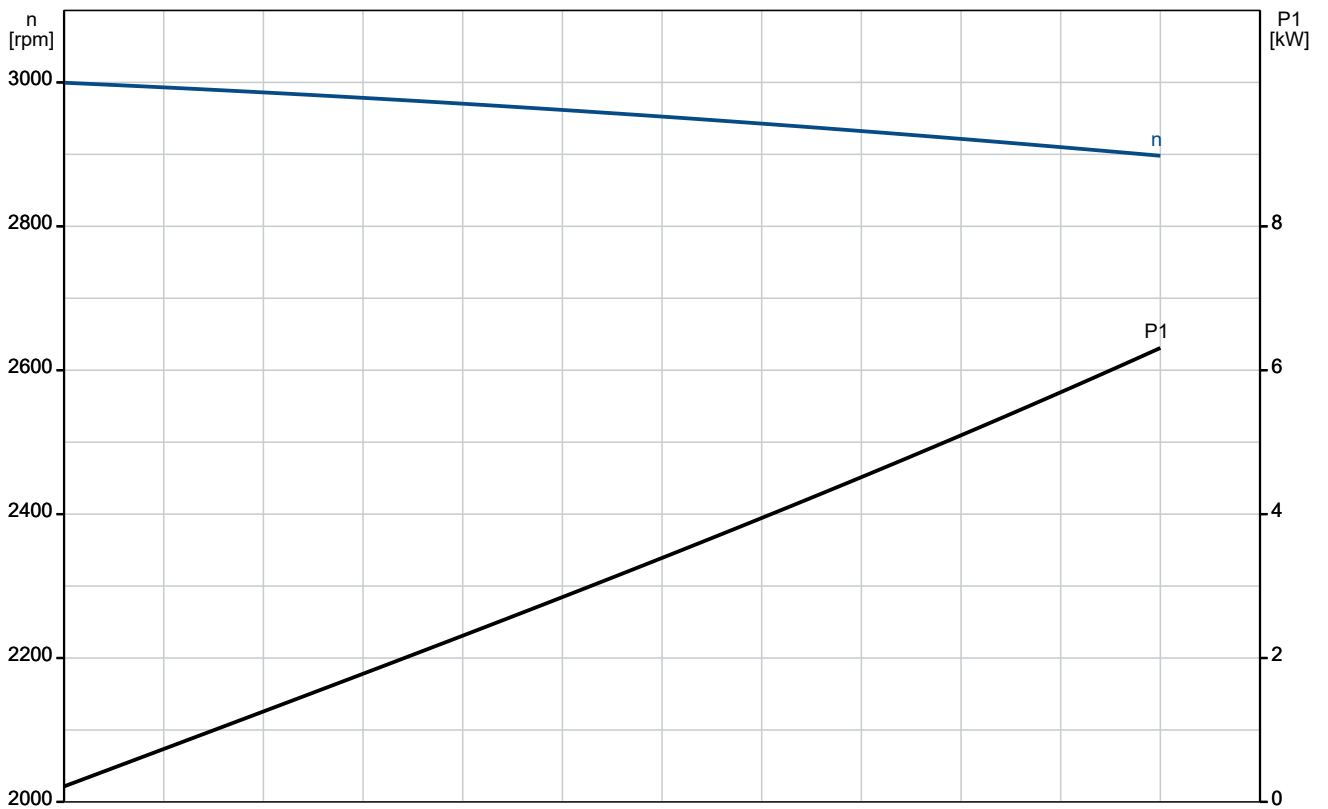
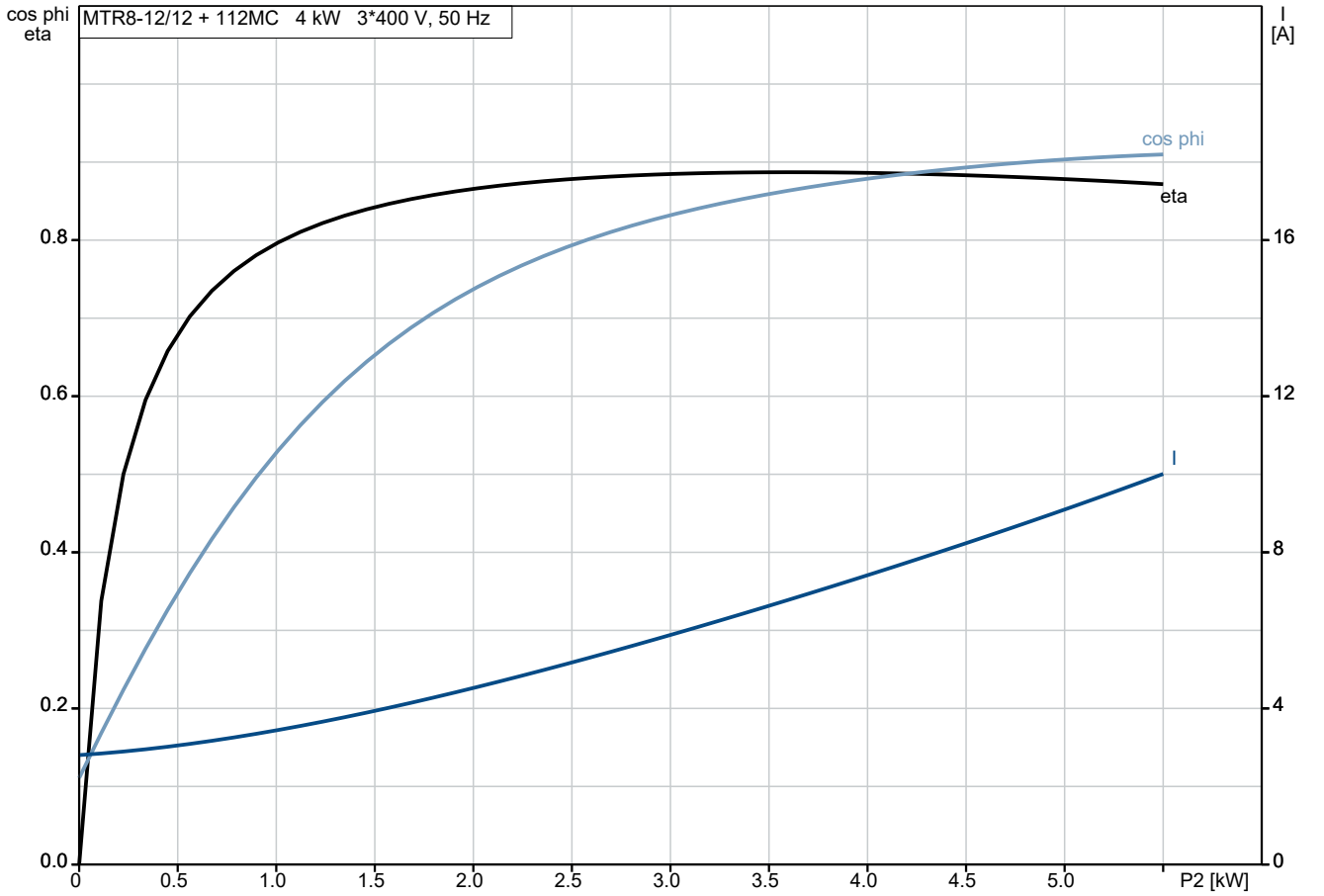

98825708 MTR 8-12/12 A-W-A-HUUV 50 Hz

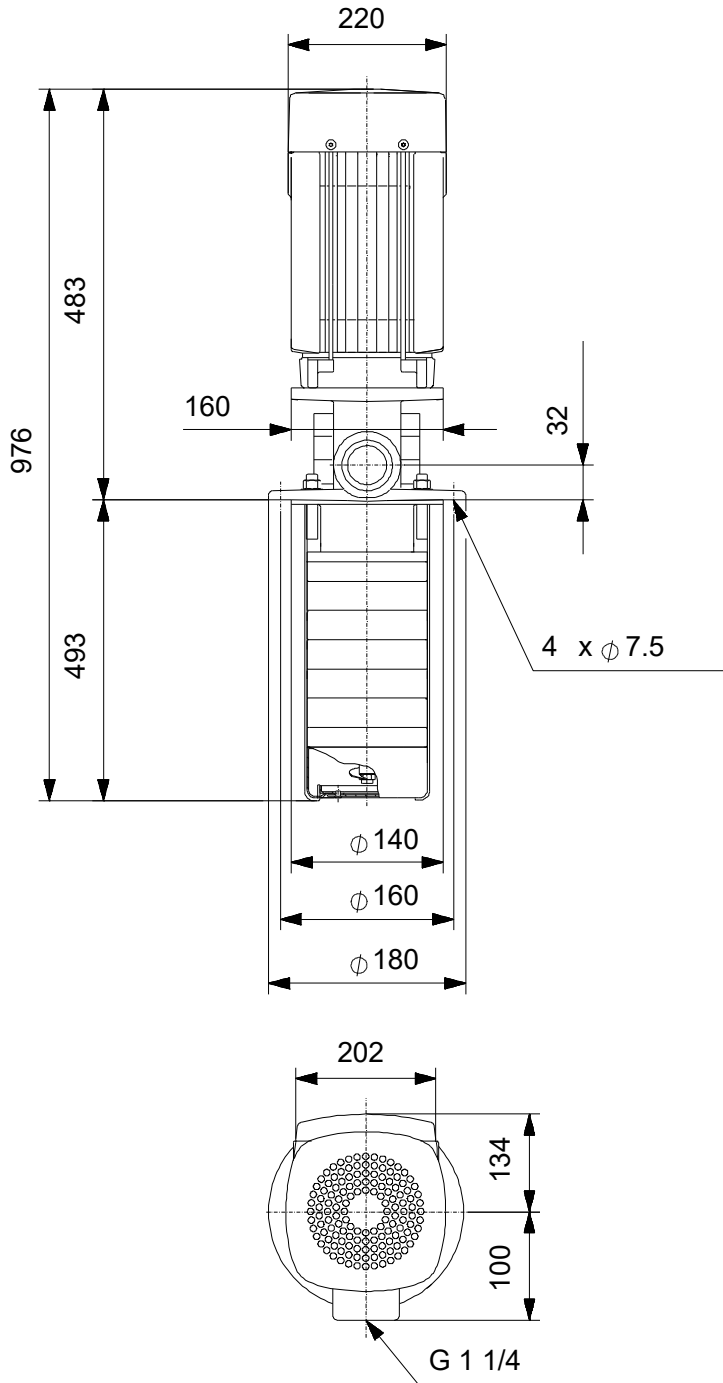

Note! All units are in [mm] unless others are stated.
Disclaimer: This simplified dimensional drawing does not show all details.

98825708 MTR 8-12/12 A-W-A-HUUV 50 Hz



IEC TP211 THERMALLY PROTECTED WHEN THE THERMISTORS ARE
CONNECTED TO AMPLIFIER RELAY FOR CONTROL OF MAIN SUPPLY
THERMISTORS PTC ACCORDING TO DIN 44082

Note! All units are in [mm] unless others are stated.

