

Qty. Description

1 TP 65-120/2 A-F-Z-BQQE-GX1



Note! Product picture may differ from actual product

Product No.: [98958004](#)

Single-stage, close-coupled, volute pump with in-line suction and discharge ports of identical diameter. The pump is of the top-pull-out design, i.e. the power head (motor, pump head and impeller) can be removed for maintenance or service while the pump housing remains in the pipework.

The pump is fitted with an unbalanced rubber bellows seal.

The shaft seal is according to EN 12756. Pipework connection is via PN 6/10 DIN flanges (EN 1092-2 and ISO 7005-2).

The pump is fitted with a fan-cooled asynchronous motor.

The bronze pump housing and stainless-steel impeller make the pump suitable for circulation of hot water.

The product's minimum efficiency index (MEI) is greater or equal to 0.70. This is by the Commission Regulation (EU) considered as an indicative benchmark for best-performing water pump available on the market as from 1 January 2013.

Cast-iron parts have an epoxy-based coating made in a cathodic electro-deposition (CED) process. CED is a high-quality dip-painting process where an electrical field around the products ensures deposition of paint particles as a thin, well-controlled layer on the surface.

## Pump

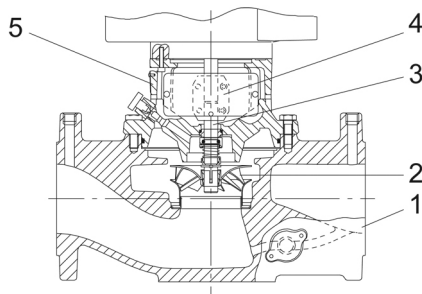

1: Pump housing

2: Impeller

3: Shaft

4: Coupling

5: Pump head

The pump housing is provided with a replaceable stainless steel/PTFE neck ring to reduce the amount of liquid running from the discharge side of the impeller to the suction side.

The impeller is secured with a split cone with nut.

The pump is fitted with an unbalanced rubber bellows seal with torque transmission across the spring and around the bellows. Due to the bellows, the seal does not wear the shaft, and the axial movement is not prevented by deposits on the shaft.

Seal faces:

- Rotating seal ring material: silicon carbide (SiC)
- Stationary seat material: silicon carbide (SiC)

This material pairing is used where higher corrosion resistance is required. The high hardness of this material pairing offers good resistance against abrasive particles.

Secondary seal material: EPDM (ethylene-propylene rubber)

EPDM has excellent resistance to hot water. EPDM is not suitable for mineral oils.

Qty.	Description
1	<p>A circulation of liquid through the duct of the air vent screw ensures lubrication and cooling of the shaft seal. The flanges have tappings for mounting of pressure gauges.</p> <p>The motor stool forms connection between the pump housing and the motor, and is equipped with a manual air vent screw for venting of the pump housing and the shaft seal chamber. The sealing between motor stool and pump housing is an O-ring.</p> <p>The central part of the motor stool is provided with guards for protection against the shaft and coupling. Motor and pump shaft are connected via a shell coupling.</p> <p><b>Motor</b></p> <p>The motor is a totally enclosed, fan-cooled motor with principal dimensions to IEC and DIN standards. Electrical tolerances comply with IEC 60034.</p> <p>The motor is flange-mounted with tapped-hole flange (FT). Motor-mounting designation in accordance with IEC 60034-7: IM B 14, IM V 18 (Code I) / IM 3601, IM 3611 (Code II).</p> <p>The motor has built-in thermal protection (PTO current and temperature sensors) in accordance with IEC 60034-11 and requires no further motor protection. The protection reacts to both slow- and quick-rising temperatures, e.g. constant overload and stalled conditions.</p> <p>As the thermal protection incorporates automatic reset, the motor must be connected in a way which ensures that the automatic reset cannot cause accidents.</p> <p><b>Further product details</b></p> <p>Cast-iron parts have an epoxy-based coating made in a cathodic electro-deposition (CED) process. CED is a high-quality dip-painting process where an electrical field around the products ensures deposition of paint particles as a thin, well-controlled layer on the surface.</p> <p><b>Technical data</b></p> <p>Controls:</p> <p>Frequency converter: NONE</p> <p>Liquid:</p> <p>Pumped liquid: Water</p> <p>Liquid temperature range: -25 .. 120 °C</p> <p>Selected liquid temperature: 20 °C</p> <p>Density: 998.2 kg/m<sup>3</sup></p> <p>Technical:</p> <p>Pump speed on which pump data are based: 2880 rpm</p> <p>Rated flow: 25.7 m<sup>3</sup>/h</p> <p>Rated head: 8.3 m</p> <p>Actual impeller diameter: 91 mm</p> <p>Code for shaft seal: BQQE</p> <p>Curve tolerance: ISO9906:2012 3B2</p> <p>Materials:</p> <p>Pump housing: Bronze CuSn10 ASTM B505</p> <p>Impeller: Stainless steel EN 1.4301 AISI 304</p> <p>Installation:</p> <p>Range of ambient temperature: -30 .. 40 °C</p> <p>Maximum operating pressure: 10 bar</p> <p>Max pressure at stated temp: 10 bar / 120 °C</p> <p>Type of connection: DIN</p> <p>Size of connection: DN 65</p>

Qty.	Description
------	-------------

1	Pressure rating for connection: PN 6/10 Port-to-port length: 340 mm Flange size for motor: FT115  Electrical data: Motor type: 90SB Rated power - P2: 1.1 kW Mains frequency: 50 Hz Rated voltage: 1 x 220-230/240 V Rated current: 7.40/6.70 A Starting current: 390 % Cos phi - power factor: 0.98/0.99 Rated speed: 2770 rpm Motor efficiency at full load: 73-71 % Number of poles: 2 Enclosure class (IEC 34-5): 55 Dust/Jetting Insulation class (IEC 85): F Motor No: 85215705  Others: Minimum efficiency index, MEI $\geq$ : 0.70 Net weight: 47.4 kg Gross weight: 52.4 kg Shipping volume: 0.091 m <sup>3</sup> Country of origin: HU Custom tariff no.: 84137051
---	---

## 98958004 TP 65-120/2 A-F-Z-BQQE-GX1 50 Hz

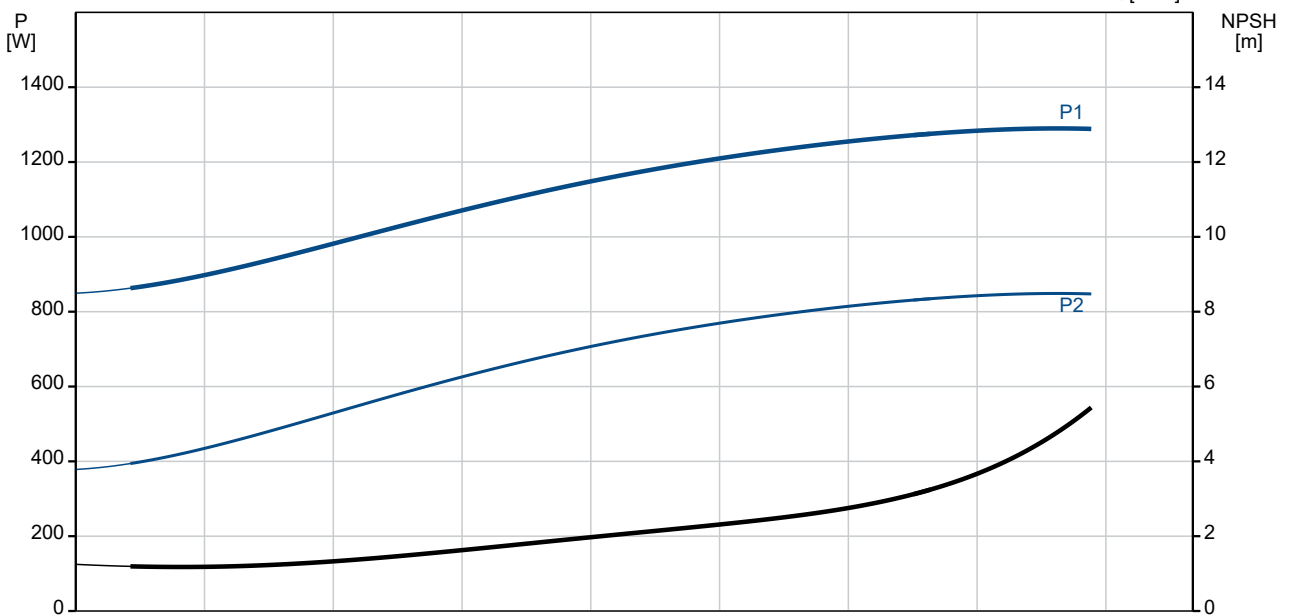
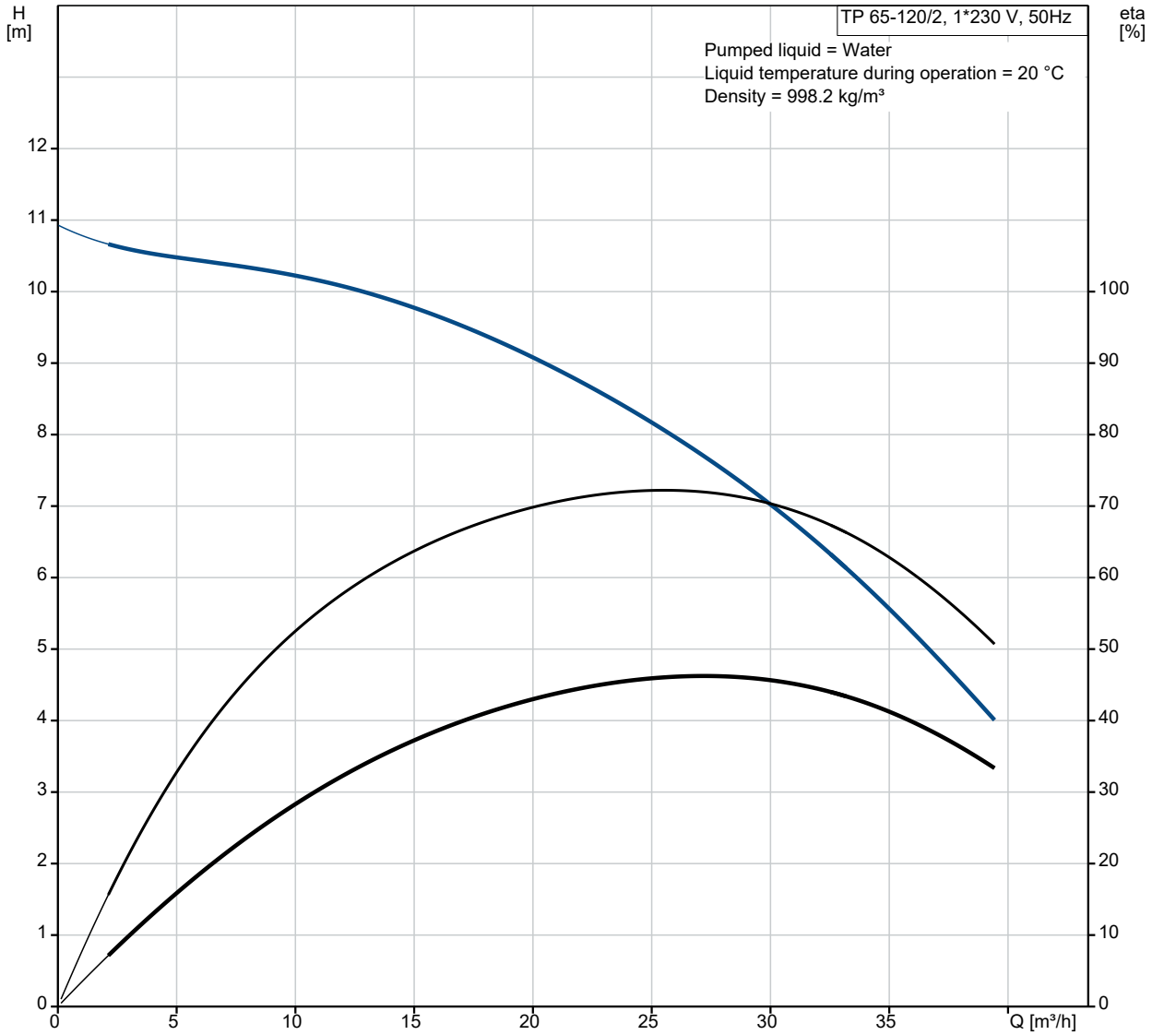

Description	Value
<b>General information:</b>	
Product name:	TP 65-120/2 A-F-Z-BQQE-GX1
Product No:	98958004
EAN number:	5712604244715
<b>Technical:</b>	
Pump speed on which pump data are based:	2880 rpm
Rated flow:	25.7 m <sup>3</sup> /h
Rated head:	8.3 m
Maximum head:	120 dm
Actual impeller diameter:	91 mm
Code for shaft seal:	BQQE
Curve tolerance:	ISO9906:2012 3B2
Pump version:	A
<b>Materials:</b>	
Pump housing:	Bronze
Pump housing:	CuSn10
Pump housing:	ASTM B505
Impeller:	Stainless steel
Impeller:	EN 1.4301
Impeller:	AISI 304
Material code:	Z
<b>Installation:</b>	
Range of ambient temperature:	-30 .. 40 °C
Maximum operating pressure:	10 bar
Max pressure at stated temp:	10 bar / 120 °C
Type of connection:	DIN
Size of connection:	DN 65
Pressure rating for connection:	PN 6/10
Port-to-port length:	340 mm
Flange size for motor:	FT115
Connect code:	F
<b>Liquid:</b>	
Pumped liquid:	Water
Liquid temperature range:	-25 .. 120 °C
Selected liquid temperature:	20 °C
Density:	998.2 kg/m <sup>3</sup>
<b>Electrical data:</b>	
Motor type:	90SB
Rated power - P2:	1.1 kW
Mains frequency:	50 Hz
Rated voltage:	1 x 220-230/240 V
Rated current:	7.40/6.70 A
Starting current:	390 %
Cos phi - power factor:	0.98/0.99
Rated speed:	2770 rpm
Motor efficiency at full load:	73-71 %
Number of poles:	2
Enclosure class (IEC 34-5):	55 Dust/Jetting
Insulation class (IEC 85):	F
Built-in motor protection:	PTO
Motor No:	85215705
<b>Controls:</b>	
Frequency converter:	NONE
<b>Others:</b>	
Minimum efficiency index, MEI ≥:	0.70
Net weight:	47.4 kg
Gross weight:	52.4 kg

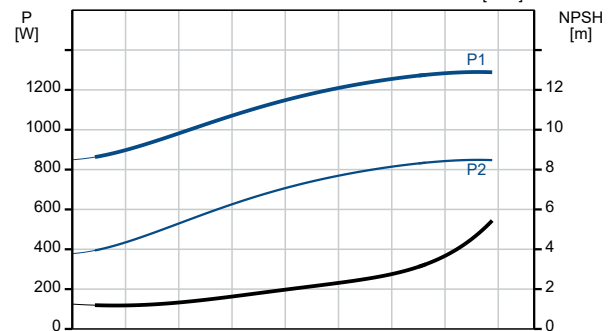
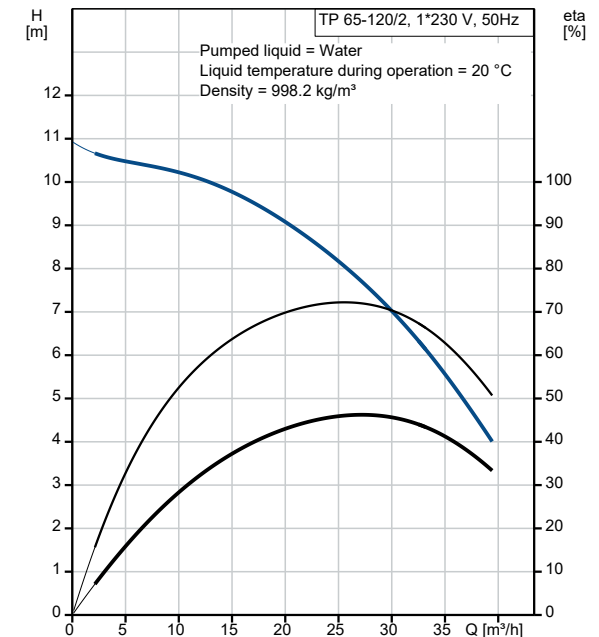



Company name:

Created by:

Phone:

Date:

08/08/2022

Description	Value
Shipping volume:	0.091 m <sup>3</sup>
Country of origin:	HU
Custom tariff no.:	84137051

## 98958004 TP 65-120/2 A-F-Z-BQQE-GX1 50 Hz

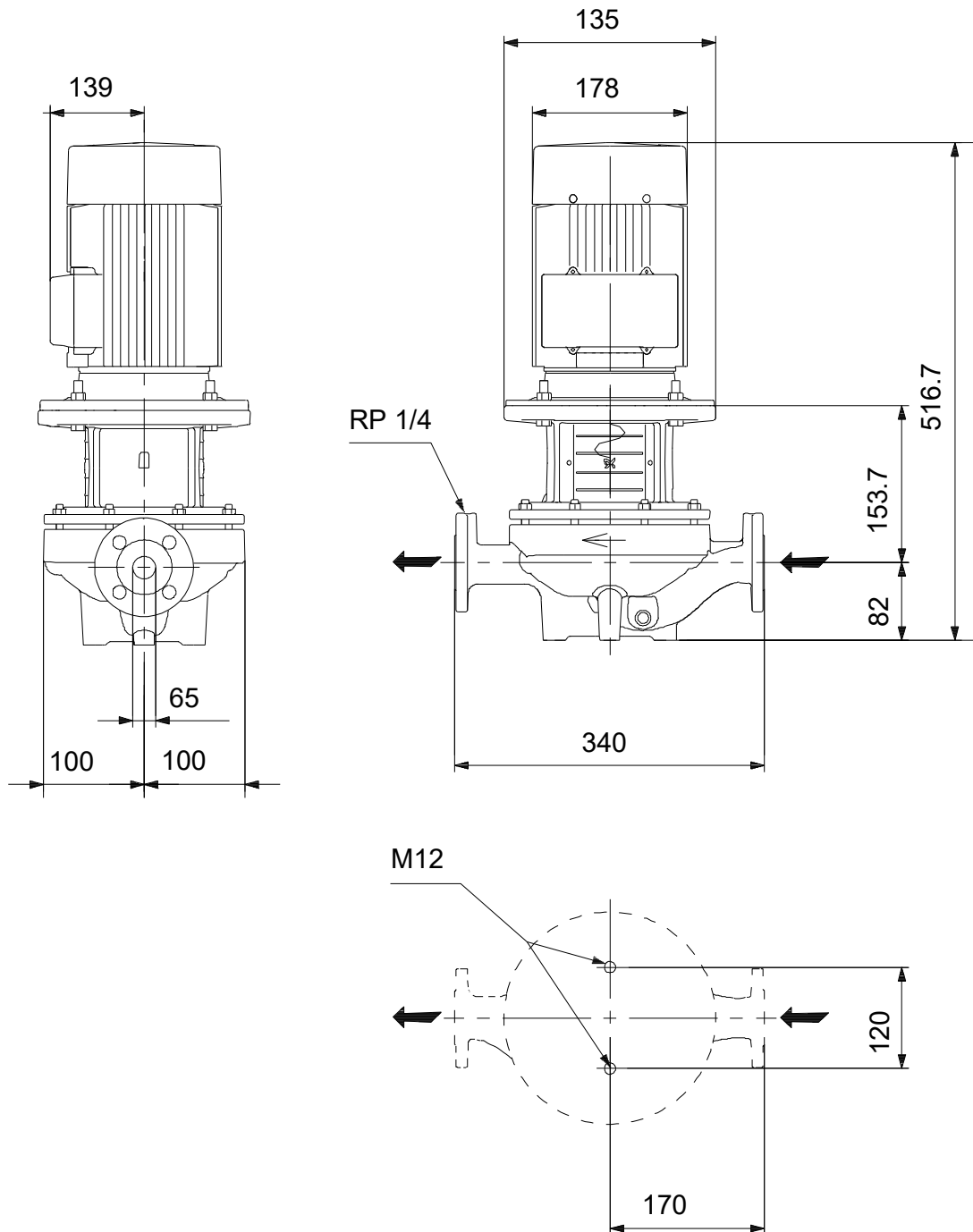

Note! All units are in [mm] unless others are stated.  
Disclaimer: This simplified dimensional drawing does not show all details.

## 98958004 TP 65-120/2 A-F-Z-BQQE-GX1 50 Hz

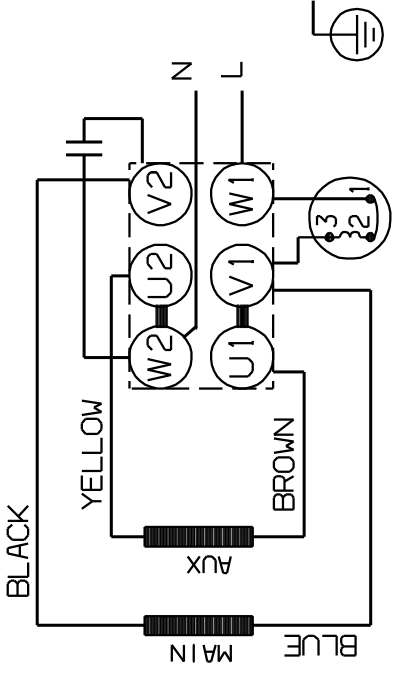
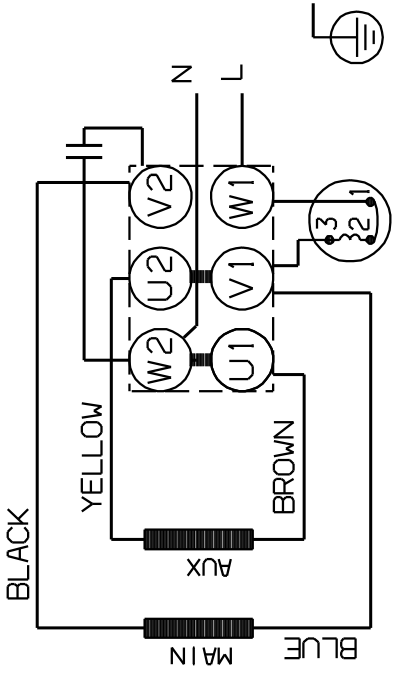
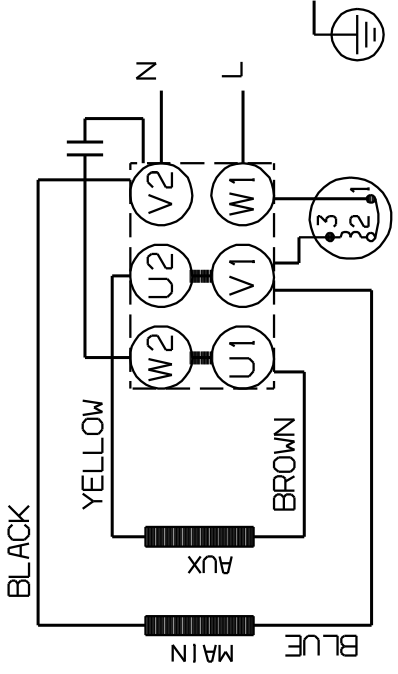
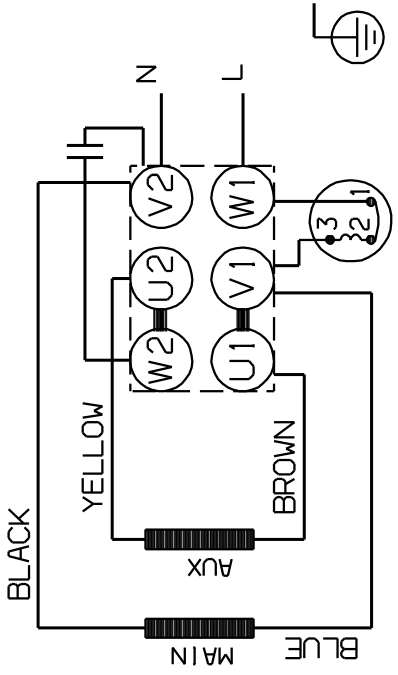
<p>DIRECTION OF ROTATION</p>	
<p>DIRECTION OF ROTATION</p>	
	
	

Note! All units are in [mm] unless others are stated.