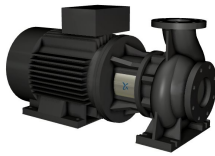

Qty. Description

1 NB 100-200/170 AASF2AESBQQRW1

Product No.: [98975724](#)

Non-self-priming, single-stage, centrifugal volute pump designed according to ISO 5199 with dimensions and rated performance according to EN 733 (10 bar).

Flanges are PN 16 with dimensions according to EN 1092-2. The pump has an axial suction port, radial discharge port, horizontal shaft and a back pull-out design enabling removal of the motor, motor stool, cover and impeller without disturbing the pump housing or pipework.

The unbalanced rubber bellows seal is according to DIN EN 12756.

The pump is close-coupled to a fan-cooled asynchronous motor.

The back pull-out design means that the pump can be serviced by a single person without disturbing the pump housing or pipes.

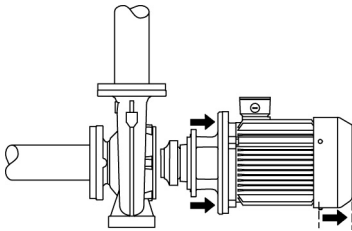

Cast-iron parts have an epoxy-based coating made in a cathodic electro-deposition (CED) process. CED is a high-quality dip-painting process where an electrical field around the products ensures deposition of paint particles as a thin, well-controlled layer on the surface.

Pump

Motor stool and pump cover are made of cast iron (EN-GJL-250). Coupling guards are fitted to the motor stool.

The pump is fitted with an unbalanced rubber bellows seal with torque transmission across the spring and around the bellows. Due to the bellows, the seal does not wear the shaft, and the axial movement is not prevented by deposits on the shaft.

Seal faces:

- Rotating seal ring material: silicon carbide (SiC)
- Stationary seat material: silicon carbide (SiC)

This material pairing is used where higher corrosion resistance is required. The high hardness of this material pairing offers good resistance against abrasive particles.

Secondary seal material: EPDM (ethylene-propylene rubber)

EPDM has excellent resistance to hot water. EPDM is not suitable for mineral oils.

The pump housing has feet.

The pump is to be secured to the foundation with bolts through the pump housing feet and motor feet. The pump is delivered with steel support blocks. The support blocks provide horizontal alignment of the pump and ensure clearance between the motor stool/motor flange and the foundation.

Motor

The motor is a totally enclosed, fan-cooled motor with principal dimensions to IEC and DIN standards. Electrical tolerances comply with IEC 60034.

The motor efficiency is classified as IE3 in accordance with IEC 60034-30-1.

The motor has thermistors (PTC sensors) in the windings in accordance with DIN 44081/DIN 44082. The protection reacts to both slow- and quick-rising temperatures, e.g. constant overload and stalled conditions.

Qty. Description

1 Thermal switches must be connected to an external control circuit in a way which ensures that the automatic reset cannot cause accidents. The motors must be connected to a motor-protective circuit breaker according to local regulations.

The motor can be connected to a variable speed drive for adjustment of pump performance to any duty point. Grundfos CUE offers a range of variable speed drives. Please find more information in Grundfos Product Center.

Further product details

Cast-iron parts have an epoxy-based coating made in a cathodic electro-deposition (CED) process. CED is a high-quality dip-painting process where an electrical field around the products ensures deposition of paint particles as a thin, well-controlled layer on the surface.

Technical data

Controls:

Frequency converter: NONE

Pressure sensor: N

Liquid:

Pumped liquid: Water

Liquid temperature range: -25 .. 120 °C

Selected liquid temperature: 20 °C

Density: 998.2 kg/m³

Technical:

Pump speed on which pump data are based: 2955 rpm

Rated flow: 268.4 m³/h

Rated head: 28.03 m

Actual impeller diameter: 170 mm

Nominal impeller diameter: 200

Shaft seal arrangement: Single

Code for shaft seal: BQQE

Curve tolerance: ISO9906:2012 3B

Bearing design: Standard

Materials:

Pump housing: Cast iron
EN-GJL-250
ASTM class 35

Wear ring: Brass

Impeller: Cast iron
EN-GJL-200
ASTM class 30

Internal pump house coating: CED

Shaft: Stainless steel
EN 1.4301
AISI 304

Installation:

t max amb: 55 °C

Maximum operating pressure: 16 bar

Pipe connection standard: EN 1092-2

Size of inlet connection: DN 125

Size of outlet connection: DN 100

Pressure rating for connection: PN 16

Bearing lubrication: Grease

Pump housing with feet: Yes

Support block (Yes/No): Y

Qty.	Description
------	-------------

1	Electrical data: Motor type: SIEMENS IE Efficiency class: IE3 Rated power - P2: 30 kW Mains frequency: 50 Hz Rated voltage: 3 x 380-420D/660-725Y V Rated current: 53/31 A Starting current: 700-700 % Cos phi - power factor: 0.87 Rated speed: 2955 rpm Efficiency: IE3 93,3% Motor efficiency at full load: 93.3-93.3 % Motor efficiency at 3/4 load: 93.5-93.5 % Motor efficiency at 1/2 load: 92.9-92.9 % Number of poles: 2 Enclosure class (IEC 34-5): IP55 Insulation class (IEC 85): F Motor No: 99032145 Bearing insulation type N-end: STEEL BEARING Others: Minimum efficiency index, MEI \geq : 0.68 Net weight: 326 kg Gross weight: 351 kg Shipping volume: 0.707 m ³ Danish VVS No.: 386065201
---	---

98975724 NB 100-200/170 AASF2AESBQQERW1 50 Hz

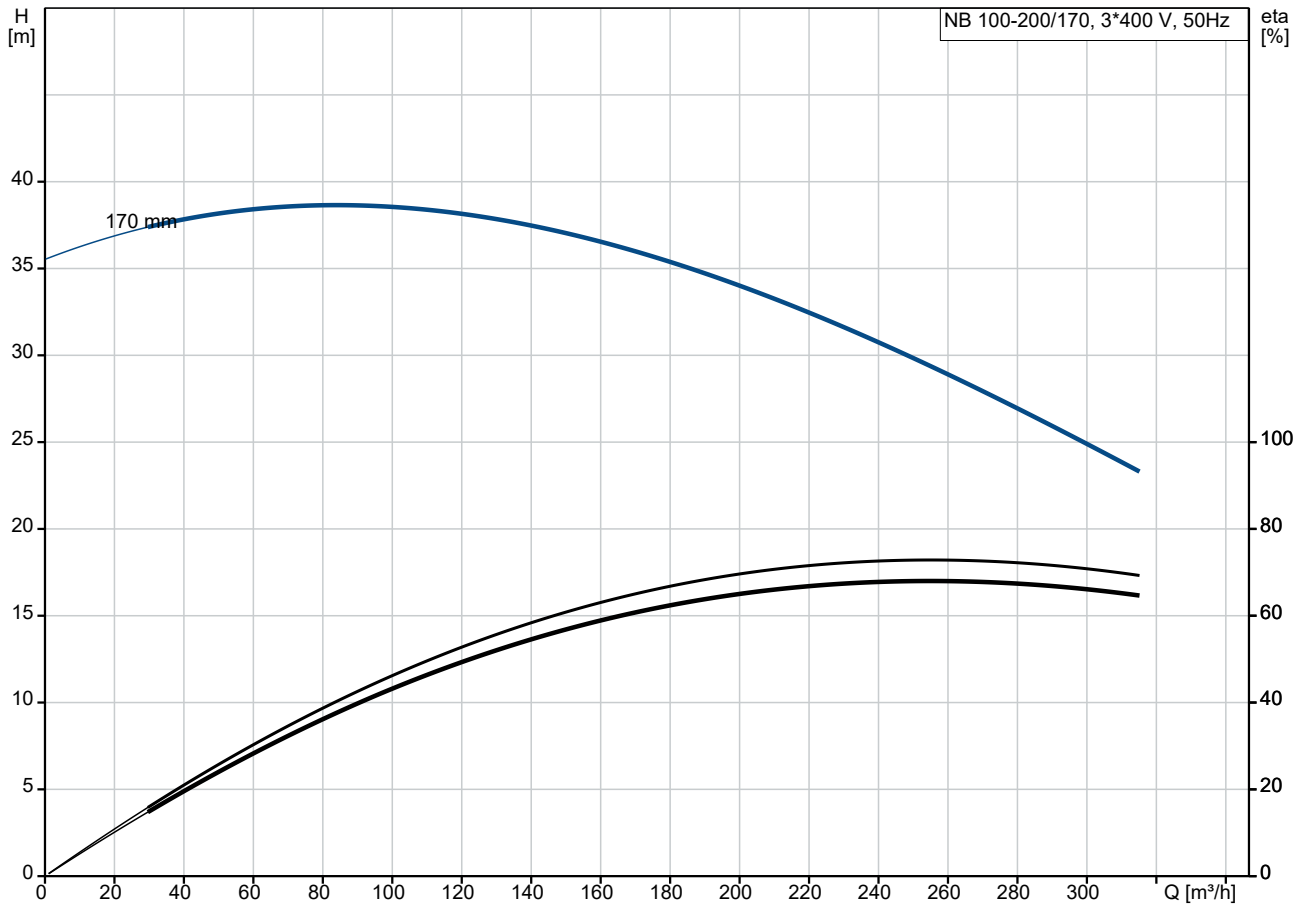

Pumped liquid = Water
 Liquid temperature during operation = 20 °C
 Density = 998.2 kg/m³

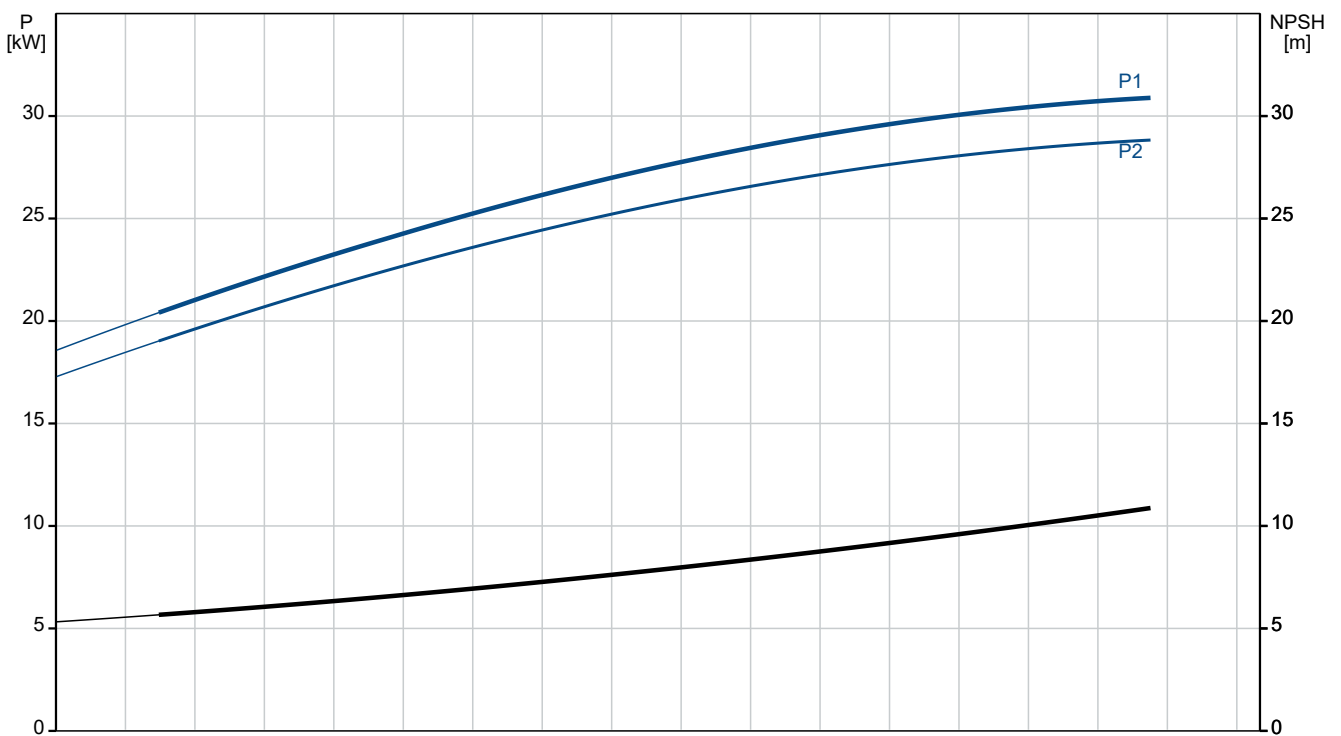

Description	Value
General information:	
Product name:	NB 100-200/170 AASF2AESBQQERW1
Product No:	98975724
EAN number:	5712604548080
Technical:	
Pump speed on which pump data are based:	2955 rpm
Rated flow:	268.4 m ³ /h
Rated head:	28.03 m
Actual impeller diameter:	170 mm
Nominal impeller diameter:	200
Shaft seal arrangement:	Single
Shaft diameter:	32 mm
Code for shaft seal:	BQQE
Curve tolerance:	ISO9906:2012 3B
Pump version:	AS
Bearing design:	Standard
Materials:	
Pump housing:	Cast iron
Pump housing:	EN-GJL-250
Pump housing:	ASTM class 35
Wear ring:	Brass
Impeller:	Cast iron
Impeller:	EN-GJL-200
Impeller:	ASTM class 30
Internal pump house coating:	CED
Material code:	A
Code for rubber:	E
Shaft:	Stainless steel
Shaft:	EN 1.4301
Shaft:	AISI 304
Installation:	
t max amb:	55 °C
Maximum operating pressure:	16 bar
Pipe connection standard:	EN 1092-2
Size of inlet connection:	DN 125
Size of outlet connection:	DN 100
Pressure rating for connection:	PN 16
Bearing lubrication:	Grease
Pump housing with feet:	Yes
Support block (Yes/No):	Y
Connect code:	F2
Liquid:	
Pumped liquid:	Water
Liquid temperature range:	-25 .. 120 °C
Selected liquid temperature:	20 °C
Density:	998.2 kg/m ³
Electrical data:	
Motor type:	SIEMENS
IE Efficiency class:	IE3
Rated power - P2:	30 kW
Mains frequency:	50 Hz
Rated voltage:	3 x 380-420D/660-725Y V
Rated current:	53/31 A
Starting current:	700-700 %
Cos phi - power factor:	0.87
Rated speed:	2955 rpm
Efficiency:	IE3 93,3%

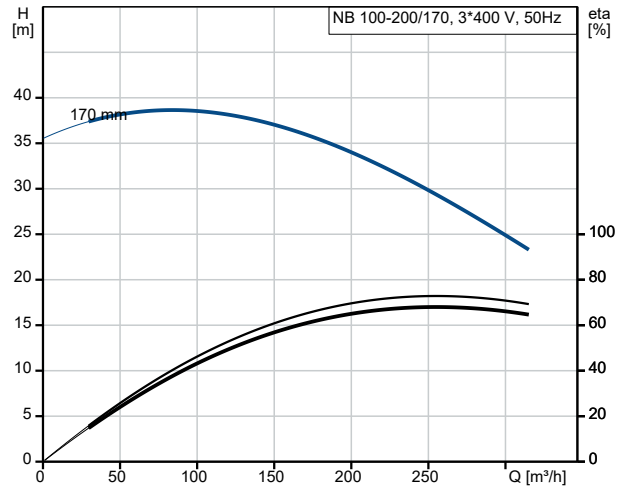

Pumped liquid = Water
Liquid temperature during operation = 20 °C
Density = 998.2 kg/m³

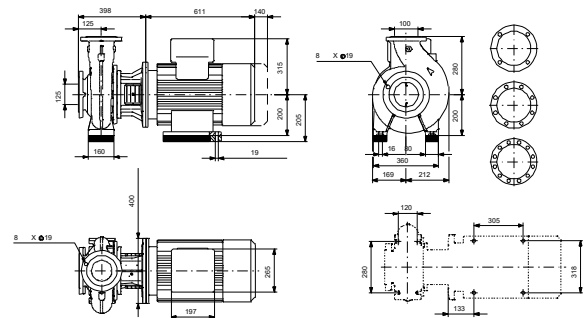
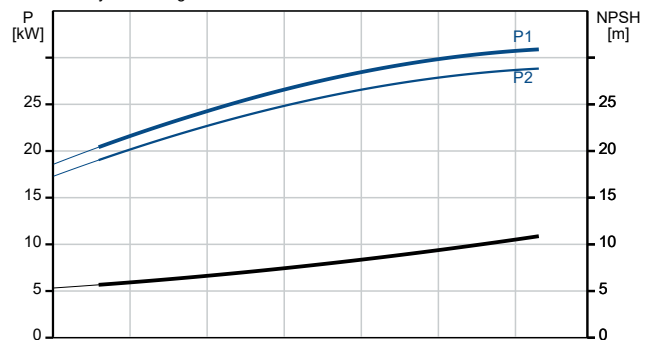



Company name:

Created by:

Phone:

Date:

30/12/2022

Description	Value
Motor efficiency at full load:	93.3-93.3 %
Motor efficiency at 3/4 load:	93.5-93.5 %
Motor efficiency at 1/2 load:	92.9-92.9 %
Number of poles:	2
Enclosure class (IEC 34-5):	IP55
Insulation class (IEC 85):	F
Built-in motor protection:	PTC
Motor No:	99032145
Mount. design. acc. IEC 34-7:	IM B35
Bearing insulation type N-end:	STEEL BEARING
Controls:	
Frequency converter:	NONE
Pressure sensor:	N
Others:	
Minimum efficiency index, MEI \geq :	0.68
Net weight:	326 kg
Gross weight:	351 kg
Shipping volume:	0.707 m ³
Danish VVS No.:	386065201

98975724 NB 100-200/170 AASF2AESBQQERW1 50 Hz

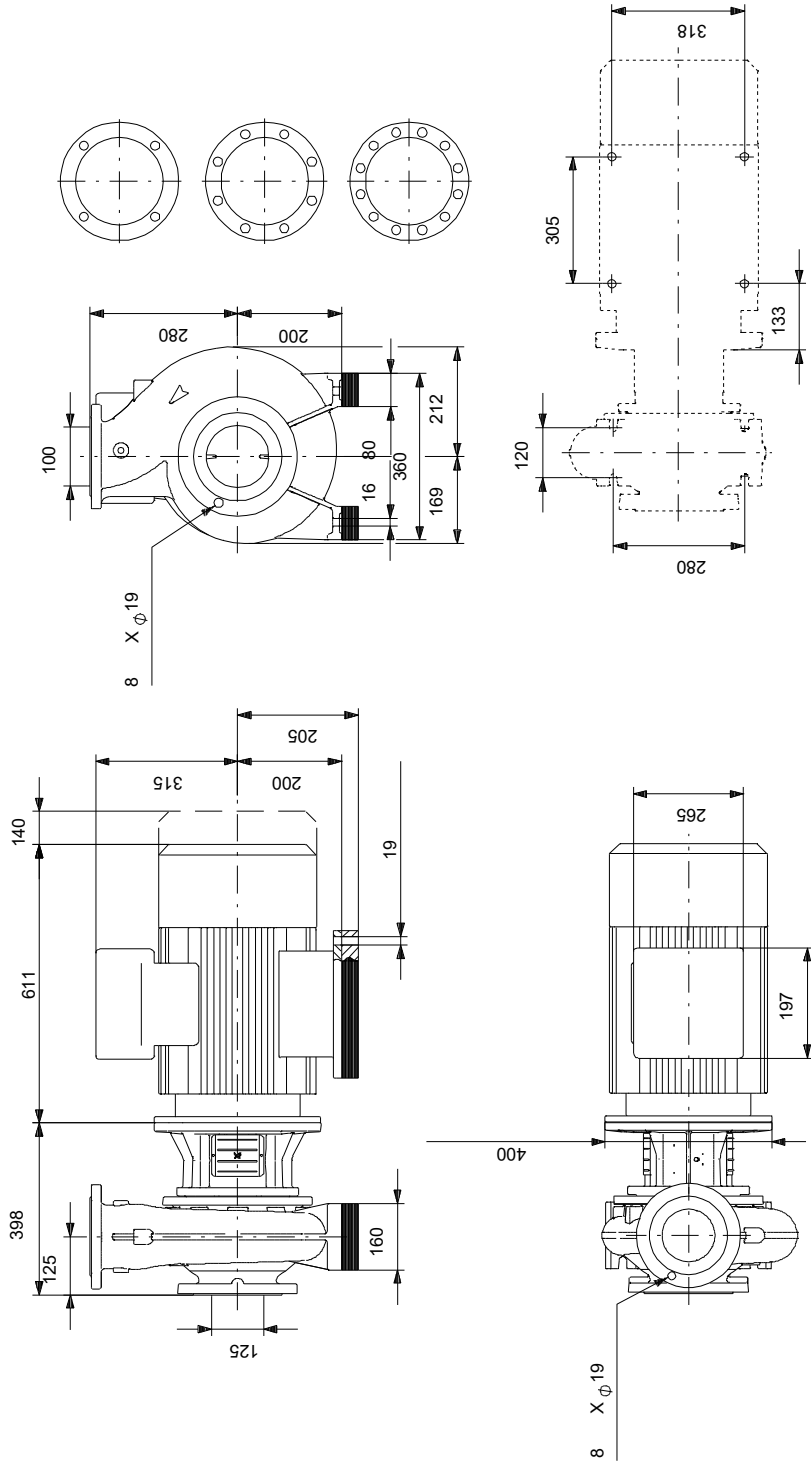

Note! All units are in [mm] unless others are stated.
Disclaimer: This simplified dimensional drawing does not show all details.

98975724 NB 100-200/170 AASF2AESBQQERW1 50 Hz



IEC TP211 THERMALLY PROTECTED WHEN THE THERMISTORS ARE
CONNECTED TO AMPLIFIER RELAY FOR CONTROL OF MAIN SUPPLY
THERMISTORS PTC ACCORDING TO DIN 44082

Note! All units are in [mm] unless others are stated.

