

Qty. Description

1 CM 3-8 A-R-G-E-AQQE F-A-A-N



Note! Product picture may differ from actual product

Product No.: On request

Compact, reliable, horizontal, multistage, end-suction centrifugal pump with axial suction port and radial discharge port. Pump materials in contact with the liquid are in high-grade stainless steel. The mechanical shaft seal is a special designed, unbalanced O-ring seal. Pipework connection is via internal Whitworth pipe threads, Rp (ISO 7/1).

The pump is fitted with a 3-phase, foot-mounted, fan-cooled asynchronous motor.

Further product details

Pump and motor are integrated in a compact and user-friendly design. The pump is fitted to a low base plate, making it ideal for installation in systems where compactness is important.

The state-of-the-art design and materials of the shaft seal ensure high wear resistance, improved sticking and dry-running capabilities and long operating life.

Servicing the pump requires no special service tools. Service parts are in stock for quick delivery and are available as kits, single parts or bulk. Service videos are available on www.youtube.com.

Pump

A combination of a stop ring and a Nord-lock® washer secures a tight and reliable fixation of the impeller spacing pipes to the splined pump shaft. It is possible to remove and fit the hydraulic parts from the pump side. The inlet and outlet port are integrated in the pump sleeve. The inlet part, chambers and discharge part are held together by four staybolts and a retaining flange.

The pump is fitted with an unbalanced O-ring seal with a rigid torque-transmission system. It has a fixed seal driver ensuring a reliable rotation of all parts. The dynamic secondary seal is an O-ring.

Seal faces:

- Rotating seal ring material: silicon carbide (SiC)
- Stationary seat material: silicon carbide (SiC)

This material pairing is used where higher corrosion resistance is required. The high hardness of this material pairing offers good resistance against abrasive particles.

Secondary seal material: EPDM (ethylene-propylene rubber)

EPDM has excellent resistance to hot water. EPDM is not suitable for mineral oils.



The pump shaft is connected to the motor shaft through a left thread and tight fit. The shaft cannot be dismantled.

Motor

The motor is a totally enclosed, fan-cooled motor with principal dimensions to EN 50347. Electrical tolerances comply with EN 60034.

The motor efficiency is classified as IE3 in accordance with IEC 60034-30-1.

Qty. Description

An installation indicator is fitted to the motor fan cover. Based on the motor cooling air, it indicates the direction of rotation of the motor. The motor is fitted with a directional sticker.

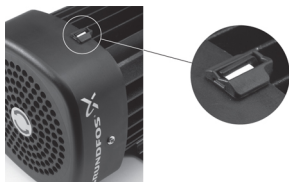

Technical data

Controls:

Frequency converter: NONE

Liquid:

Pumped liquid: Water
 Liquid temperature range: -20 .. 120 °C
 Selected liquid temperature: 20 °C
 Density: 998.2 kg/m³

Technical:

Pump speed on which pump data are based: 2900 rpm
 Rated flow: 3.1 m³/h
 Rated head: 55.66 m
 Code for shaft seal: AQQE
 Approvals: CE,EAC
 Approvals for drinking water: WRAS,ACS,NSF61,UBA
 Curve tolerance: ISO9906:2012 3B

Materials:

Pump housing: Stainless steel
 EN 1.4401
 AISI 316
 Impeller: Stainless steel
 EN 1.4401
 AISI 316

Installation:

Range of ambient temperature: -20 .. 55 °C
 Maximum operating pressure: 16 bar
 Max pressure at stated temp: 16 bar / 90 °C
 10 bar / 120 °C
 Type of connection: Rp
 Size of inlet connection: 1 inch
 Size of outlet connection: 1 inch
 Outlet position: 12

Electrical data:

Motor standard: IEC
 Frame size: 80C
 IE efficiency class: IE3
 Rated power - P2: 1.1 kW
 Mains frequency: 50 Hz
 Suitable for 50/60 Hz: N
 Rated voltage: 3 x 220-240D/380-415Y V
 Service factor: 1.00
 Rated current: 4,4-4,5/2,55-2,6 A
 Starting current: 720-780 %



Company name:

Created by:

Phone:

Date:

16/06/2022

Qty.	Description
	<p>Rated speed: 2830-2860 rpm Enclosure class (IEC 34-5): IP55 Insulation class (IEC 85): F Built-in motor protection: NONE Cable included (Yes/No): N</p> <p>Others: Terminal box position: 12 Minimum efficiency index, MEI \geq: 0.7 Net weight: 17.9 kg Gross weight: 20.4 kg Danish VVS No.: 385210308 Finnish LVI No.: 4925784 Country of origin: HU Custom tariff no.: 84137075</p>

Description	Value
General information:	
Product name:	CM 3-8 A-R-G-E-AQQE F-A-A-N
Product No:	On request
EAN number:	On request
Technical:	
Pump speed on which pump data are based:	2900 rpm
Rated flow:	3.1 m ³ /h
Rated head:	55.66 m
Impellers:	8
Code for shaft seal:	AQQE
Approvals:	CE,EAC
Approvals for drinking water:	WRAS,ACS,NSF61,UBA
Curve tolerance:	ISO9906:2012 3B
Pump version:	A
Model:	A
Materials:	
Pump housing:	Stainless steel
Pump housing:	EN 1.4401
Pump housing:	AISI 316
Impeller:	Stainless steel
Impeller:	EN 1.4401
Impeller:	AISI 316
Material code:	G
Code for rubber:	E
Installation:	
Range of ambient temperature:	-20 .. 55 °C
Maximum operating pressure:	16 bar
Max pressure at stated temp:	16 bar / 90 °C
Max pressure at stated temp:	10 bar / 120 °C
Type of connection:	Rp
Size of inlet connection:	1 inch
Size of outlet connection:	1 inch
Outlet position:	12
Connect code:	R
Liquid:	
Pumped liquid:	Water
Liquid temperature range:	-20 .. 120 °C
Selected liquid temperature:	20 °C
Density:	998.2 kg/m ³
Electrical data:	
Motor standard:	IEC
Frame size:	80C
IE efficiency class:	IE3
Rated power - P2:	1.1 kW
Mains frequency:	50 Hz
Suitable for 50/60 Hz:	N
Rated voltage:	3 x 220-240D/380-415Y V
Service factor:	1.00
Rated current:	4,4-4,5/2,55-2,6 A
Starting current:	720-780 %
Rated speed:	2830-2860 rpm
Enclosure class (IEC 34-5):	IP55
Insulation class (IEC 85):	F
Built-in motor protection:	NONE
Cable included (Yes/No):	N
Controls:	
Frequency converter:	NONE

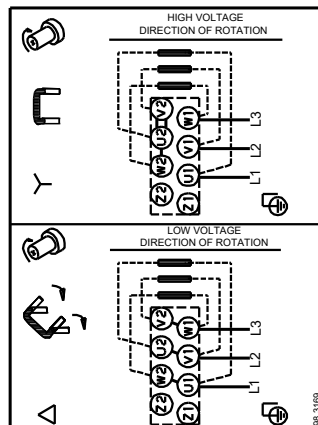
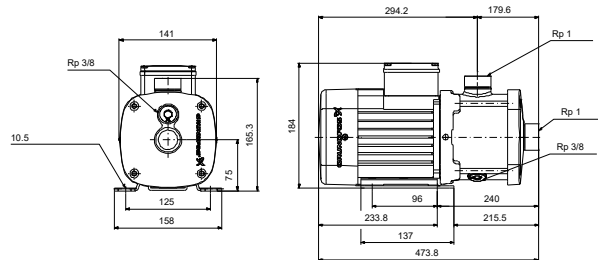
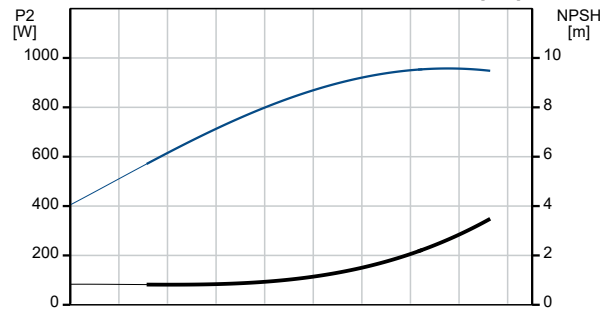
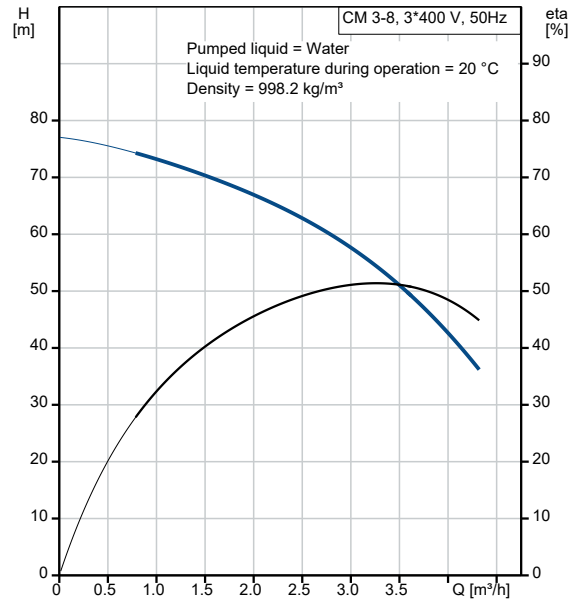



Company name:

Created by:

Phone:

Date:

16/06/2022

Description	Value
Others:	
Terminal box position:	12
Minimum efficiency index, MEI ≥:	0.7
Net weight:	17.9 kg
Gross weight:	20.4 kg
Danish VVS No.:	385210308
Finnish LVI No.:	4925784
Country of origin:	HU
Custom tariff no.:	84137075

On request CM 3-8 A-R-G-E-AQQE F-A-A-N 50 Hz

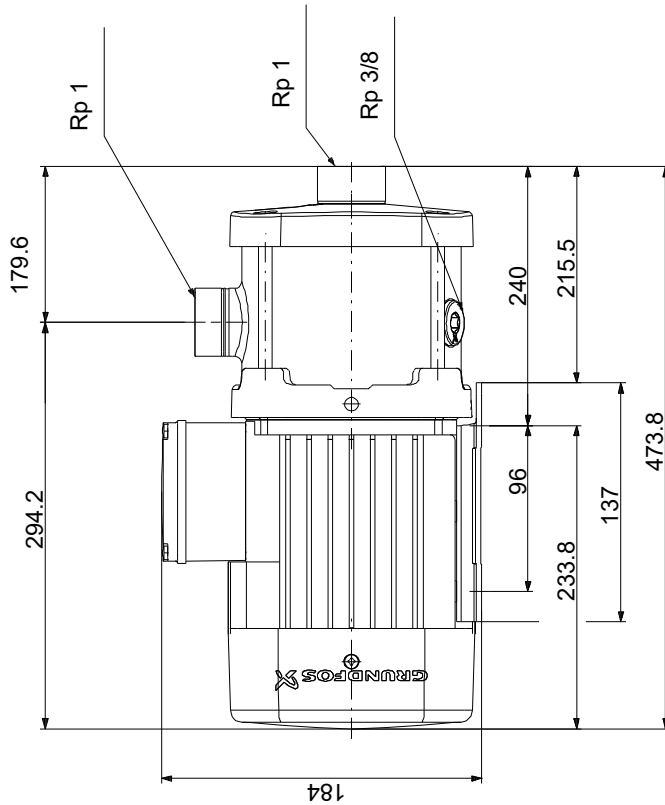

Note! All units are in [mm] unless others are stated.
Disclaimer: This simplified dimensional drawing does not show all details.



Company name:

Created by:

Phone:

Date:

16/06/2022

Order Data:

Product name: CM 3-8

Amount: 1

Product No: On request

Total: Price on request
