

Qty.	Description
1	<p data-bbox="199 338 523 365">CRIE 15-2 A-FGJ-A-E-HQQE</p>  <p data-bbox="592 685 1062 707">Note! Product picture may differ from actual product</p> <p data-bbox="199 719 478 741">Product No.: On request</p> <p data-bbox="199 779 1458 853">Vertical, multistage centrifugal pump with inlet and outlet ports on same the level (inline). Pump materials in contact with the liquid are in stainless steel. A cartridge shaft seal ensures high reliability, safe handling, and easy access and service. Power transmission is via a rigid split coupling. Pipe connection is via combined DIN-ANSI-JIS flanges.</p> <p data-bbox="199 920 1126 943">The pump is fitted with a 3-phase, fan-cooled, permanent-magnet, synchronous motor.</p> <p data-bbox="199 949 1015 972">The motor efficiency is classified as IE5 in accordance with IEC 60034-30-2.</p> <p data-bbox="199 978 1394 1030">The motor includes a frequency converter and PI controller in the motor terminal box. This enables continuously variable control of the motor speed, which again enables adaptation of the performance to a given requirement.</p> <p data-bbox="199 1037 1449 1111">An operating panel on the motor terminal box enables setting of required setpoint as well as setting of pump to "Min." or "Max." operation or to "Stop". The Grundfos Eye indicator on the operating panel provides visual indication of pump status:</p> <ul data-bbox="240 1122 1458 1267" style="list-style-type: none"> • "Power on": Motor is running (rotating green indicator lights) or not running (permanently green indicator lights) • "Warning": Motor is still running (rotating yellow indicator lights) or has stopped (permanently yellow indicator lights) • "Alarm": Motor has stopped (flashing red indicator lights). <p data-bbox="199 1272 1422 1346">Communication with the pump is possible by means of Grundfos GO Remote (accessory). The remote control enables further settings as well as reading out of a number of parameters such as "Actual value", "Speed", "Power input" and total "Power consumption".</p> <p data-bbox="199 1352 1437 1404">The terminal box has a number of inputs and outputs enabling the motor to be used in advanced applications where many inputs and outputs are required:</p> <ul data-bbox="240 1415 900 1765" style="list-style-type: none"> • two dedicated digital inputs • three analog inputs, 0(4)-20 mA, 0-5 V, 0-10 V, 0.5 - 3.5 V • 5 V voltage supply to potentiometer and sensor • one analog output, 0-10 V, 0(4)-20 mA • two configurable digital inputs or open-collector outputs • two Pt100/Pt1000 inputs • LiqTec, dry-running protection sensor input • Grundfos Digital Sensor input and output • 24 V voltage supply for sensors • two signal-relay outputs (potential-free contacts) • GENIbus connection • interface for Grundfos CIM fieldbus module. <p data-bbox="199 1798 512 1827">Further product details</p> <p data-bbox="199 1834 1449 1886">An external sensor can be connected if controlled pump operation based on for example flow, differential pressure or temperature is required.</p> <p data-bbox="199 1892 1449 1966">An operating panel on the motor terminal box enables setting of required setpoint as well as setting of pump to "Min." or "Max." operation or to "Stop". The Grundfos Eye indicator on the operating panel provides visual indication of pump status:</p> <ul data-bbox="240 1977 1458 2089" style="list-style-type: none"> • "Power on": Motor is running (rotating green indicator lights) or not running (permanently green indicator lights) • "Warning": Motor is still running (rotating yellow indicator lights) or has stopped (permanently yellow indicator lights)

Qty. Description

- "Alarm": Motor has stopped (flashing red indicator lights).

Communication with the pump is possible by means of Grundfos GO Remote (accessory). The remote control enables further settings as well as reading out of a number of parameters such as "Actual value", "Speed", "Power input" and total "Power consumption".

Steel, cast iron and aluminium components have an epoxy-based coating made in a cathodic electro-deposition (CED) process.

CED is a high-quality dip-painting process where an electrical field around the products ensures deposition of paint particles as a thin, well-controlled layer on the surface.

An integral part of the process is a pretreatment.

The entire process consists of these elements:

- 1) Alkaline-based cleaning.
- 2) Zinc phosphating.
- 3) Cathodic electro-deposition.
- 4) Curing to a dry film thickness 18-22 my m.

The colour code for the finished product is NCS 9000/RAL 9005.

Pump

A standard split coupling connects the pump and motor shaft. It is enclosed in the pump head/motor stool by means of two coupling guards.

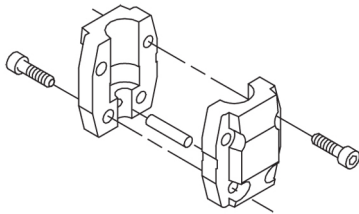

The pump head and flange for motor mounting is made in one piece (cast iron). The pump head cover is a separate component (stainless steel). The pump head has a combined 1/2" priming plug and vent screw.

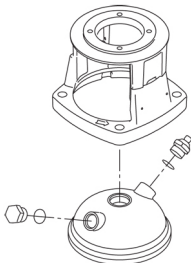

The pump is fitted with a balanced O-ring seal unit with a rigid torque-transmission system.

This seal type is assembled in a cartridge unit which makes replacement safe and easy.

Due to the balancing, this seal type is suitable for high-pressure applications.

The cartridge construction also protects the pump shaft from possible wear from a dynamic O-ring between pump shaft and shaft seal.

Seal faces:

- Rotating seal ring material: silicon carbide (SiC)
- Stationary seat material: silicon carbide (SiC)

This material pairing is used where higher corrosion resistance is required. The high hardness of this material pairing offers good resistance against abrasive particles.

Secondary seal material: EPDM (ethylene-propylene rubber)

EPDM has excellent resistance to hot water. EPDM is not suitable for mineral oils.

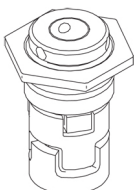

The shaft seal is screwed into the pump head.

Qty.	Description
	<p>The chambers and impellers are made of stainless-steel sheet. The chambers are provided with a PTFE neck ring offering improved sealing and high efficiency. The impellers have smooth surfaces, and the shape of the blades ensure a high efficiency.</p> <p>The pump has a stainless steel base mounted on a separate base plate. This base and base plate are kept in position by the tension of the staybolts which hold the pump together. The outlet side of the base has a combined drain plug and bypass valve. The pump is secured to the foundation by four bolts through the base plate. The flanges and base are cast in one piece and prepared for connection by means of DIN, ANSI or JIS.</p> <p>Motor</p> <p>The motor is a totally enclosed, fan-cooled motor with principal dimensions to IEC and DIN standards. The motor is flange-mounted with tapped-hole flange (FT). Motor-mounting designation in accordance with IEC 60034-7: IM B 14 (Code I) / IM 3601 (Code II). Electrical tolerances comply with IEC 60034. The motor efficiency is classified as IE5 in accordance with IEC 60034-30-2. The motor requires no external motor protection. The motor control unit incorporates protection against slow- and quick-rising temperatures, e.g. constant overload and stalled conditions. The terminal box has a number of inputs and outputs enabling the motor to be used in advanced applications where many inputs and outputs are required:</p> <ul style="list-style-type: none"> • two dedicated digital inputs • three analog inputs, 0(4)-20 mA, 0-5 V, 0-10 V, 0.5 - 3.5 V • 5 V voltage supply to potentiometer and sensor • one analog output, 0-10 V, 0(4)-20 mA • two configurable digital inputs or open-collector outputs • two Pt100/Pt1000 inputs • LiqTec, dry-running protection sensor input • Grundfos Digital Sensor input and output • 24 V voltage supply for sensors • two signal-relay outputs (potential-free contacts) • GENibus connection • interface for Grundfos CIM fieldbus module. <p>Technical data</p> <p>Liquid: Pumped liquid: Water Liquid temperature range: -20 .. 120 °C Selected liquid temperature: 20 °C Density: 998.2 kg/m³</p> <p>Technical: Pump speed on which pump data are based: 3514 rpm Rated flow: 20.5 m³/h Rated head: 31.6 m Pump orientation: Vertical Shaft seal arrangement: Single Code for shaft seal: HQQE Approvals: CE,EAC,UKCA,SEPRO Approvals for drinking water: WRAS,ACS Curve tolerance: ISO9906:2012 3B</p> <p>Materials: Base: Stainless steel EN 1.4408 AISI 316 Impeller: Stainless steel EN 1.4301 AISI 304</p>

Qty.	Description
	<p>Bearing: SIC</p> <p>Installation:</p> <p>t max amb: 50 °C</p> <p>Maximum operating pressure: 16 bar</p> <p>Max pressure at stated temp: 16 bar / 120 °C 16 bar / -20 °C</p> <p>Type of connection: DIN / ANSI / JIS</p> <p>Size of inlet connection: DN 50</p> <p>Size of outlet connection: DN 50</p> <p>Pressure rating for connection: PN 25</p> <p>Flange rating inlet: 300 lb</p> <p>Flange size for motor: FT130</p> <p>Electrical data:</p> <p>Motor standard: IEC</p> <p>Motor type: 100LA</p> <p>IE Efficiency class: IE5</p> <p>Rated power - P2: 3 kW</p> <p>Power (P2) required by pump: 3 kW</p> <p>Mains frequency: 50 / 60 Hz</p> <p>Rated voltage: 3 x 380-500 V</p> <p>Rated current: 5.80-4.80 A</p> <p>Cos phi - power factor: 0.91-0.86</p> <p>Rated speed: 360-4000 rpm</p> <p>Efficiency: 90.7%</p> <p>Motor efficiency at full load: 90.7 %</p> <p>Enclosure class (IEC 34-5): IP55</p> <p>Insulation class (IEC 85): F</p> <p>Motor No: 98971049</p> <p>Controls:</p> <p>Frequency converter: Built-in</p> <p>Pressure sensor: N</p> <p>Others:</p> <p>Minimum efficiency index, MEI ≥: 0.70</p> <p>Net weight: 55 kg</p> <p>Gross weight: 83 kg</p> <p>Shipping volume: 0.37 m³</p> <p>Country of origin: GB</p> <p>Custom tariff no.: 84137075</p>

Description	Value
General information:	
Product name:	CRIE 15-2 A-FGJ-A-E-HQQE
Product No:	On request
EAN number:	On request
Technical:	
Pump speed on which pump data are based:	3514 rpm
Rated flow:	20.5 m ³ /h
Rated head:	31.6 m
Maximum head:	41.3 m
Stages:	2
Impellers:	2
Number of reduced-diameter impellers:	0
Low NPSH:	N
Pump orientation:	Vertical
Shaft seal arrangement:	Single
Code for shaft seal:	HQQE
Approvals:	CE,EAC,UKCA,SEPRO
Approvals for drinking water:	WRAS,ACS
Curve tolerance:	ISO9906:2012 3B
Pump version:	A
Model:	A
Materials:	
Base:	Stainless steel
Base:	EN 1.4408
Base:	AISI 316
Impeller:	Stainless steel
Impeller:	EN 1.4301
Impeller:	AISI 304
Material code:	A
Code for rubber:	E
Bearing:	SIC
Installation:	
t max amb:	50 °C
Maximum operating pressure:	16 bar
Max pressure at stated temp:	16 bar / 120 °C
Max pressure at stated temp:	16 bar / -20 °C
Type of connection:	DIN / ANSI / JIS
Size of inlet connection:	DN 50
Size of outlet connection:	DN 50
Pressure rating for connection:	PN 25
Flange rating inlet:	300 lb
Flange size for motor:	FT130
Connect code:	FGJ
Liquid:	
Pumped liquid:	Water
Liquid temperature range:	-20 .. 120 °C
Selected liquid temperature:	20 °C
Density:	998.2 kg/m ³
Electrical data:	
Motor standard:	IEC
Motor type:	100LA
IE Efficiency class:	IE5
Rated power - P2:	3 kW
Power (P2) required by pump:	3 kW
Mains frequency:	50 / 60 Hz
Rated voltage:	3 x 380-500 V
Rated current:	5.80-4.80 A

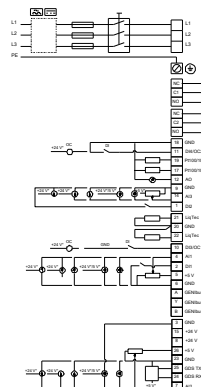
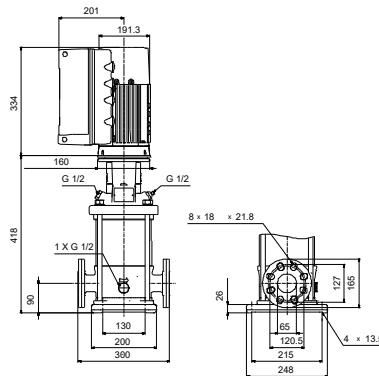
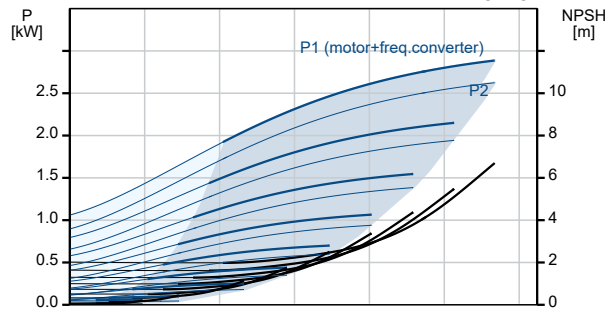
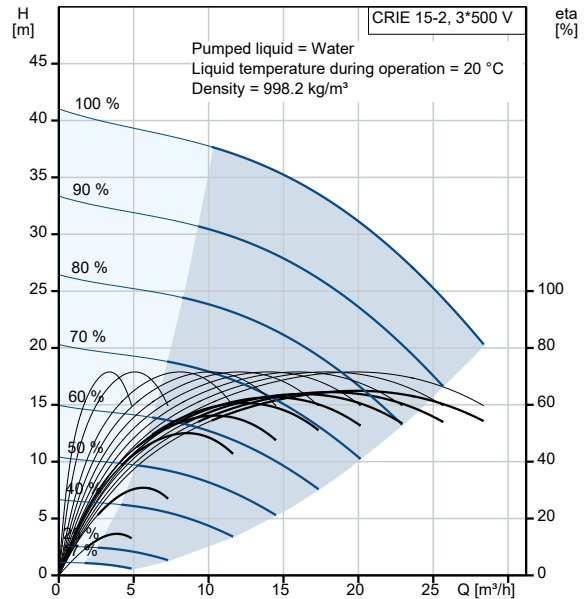



Company name:

Created by:

Phone:

Date:

16/06/2022

Description	Value
Cos phi - power factor:	0.91-0.86
Rated speed:	360-4000 rpm
Efficiency:	90.7%
Motor efficiency at full load:	90.7 %
Enclosure class (IEC 34-5):	IP55
Insulation class (IEC 85):	F
Built-in motor protection:	ELEC
Motor No:	98971049
Controls:	
Control panel:	Standard
Function Module:	FM300 - Advanced
Frequency converter:	Built-in
Pressure sensor:	N
Others:	
Minimum efficiency index, MEI \geq :	0.70
Net weight:	55 kg
Gross weight:	83 kg
Shipping volume:	0.37 m ³
Config. file no:	99059031
Country of origin:	GB
Custom tariff no.:	84137075



Company name:

Created by:

Phone:

Date:

16/06/2022

Order Data:

Product name: CRIE 15-2

Amount: 1

Product No: On request

Total: Price on request
