

Qty. Description

1 CRIE 10-17 N-FGJ-A-E-HQQE



Note! Product picture may differ from actual product

Product No.: [99071810](#)

Vertical, multistage centrifugal pump with inlet and outlet ports on same the level (inline). Pump materials in contact with the liquid are in stainless steel. A cartridge shaft seal ensures high reliability, safe handling, and easy access and service. Power transmission is via a rigid split coupling. Pipe connection is via combined DIN-ANSI-JIS flanges.

The pump is fitted with a 3-phase, fan-cooled, permanent-magnet, synchronous motor.

The motor efficiency is classified as IE5 in accordance with IEC 60034-30-2.

The motor includes a frequency converter and PI controller in the motor terminal box. This enables continuously variable control of the motor speed, which again enables adaptation of the performance to a given requirement.

An operating panel on the motor terminal box enables setting of required setpoint as well as setting of pump to "Min." or "Max." operation or to "Stop". The Grundfos Eye indicator on the operating panel provides visual indication of pump status:

- "Power on": Motor is running (rotating green indicator lights) or not running (permanently green indicator lights)
- "Warning": Motor is still running (rotating yellow indicator lights) or has stopped (permanently yellow indicator lights)
- "Alarm": Motor has stopped (flashing red indicator lights).

Communication with the pump is possible by means of Grundfos GO Remote (accessory). The remote control enables further settings as well as reading out of a number of parameters such as "Actual value", "Speed", "Power input" and total "Power consumption".

The terminal box has a number of inputs and outputs enabling the motor to be used in advanced applications where many inputs and outputs are required:

- two dedicated digital inputs
- three analog inputs, 0(4)-20 mA, 0-5 V, 0-10 V, 0.5 - 3.5 V; the factory-fitted pressure sensor is connected to one of these inputs
- 5 V voltage supply to potentiometer and sensor
- one analog output, 0-10 V, 0(4)-20 mA
- two configurable digital inputs or open-collector outputs
- two Pt100/Pt1000 inputs
- LiqTec, dry-running protection sensor input
- Grundfos Digital Sensor input and output
- 24 V voltage supply for sensors
- two signal-relay outputs (potential-free contacts)
- GENIbus connection
- interface for Grundfos CIM fieldbus module.

Further product details

The pump is equipped with a pressure sensor registering pump outlet pressure and enabling controlled pump operation based on constant pressure.

An operating panel on the motor terminal box enables setting of required setpoint as well as setting of pump to "Min." or "Max." operation or to "Stop". The Grundfos Eye indicator on the operating panel provides visual indication of pump status:

- "Power on": Motor is running (rotating green indicator lights) or not running (permanently green indicator lights)
-

Qty. Description

1

"Warning": Motor is still running (rotating yellow indicator lights) or has stopped (permanently yellow indicator lights)

- "Alarm": Motor has stopped (flashing red indicator lights).

Communication with the pump is possible by means of Grundfos GO Remote (accessory). The remote control enables further settings as well as reading out of a number of parameters such as "Actual value", "Speed", "Power input" and total "Power consumption".

Steel, cast iron and aluminium components have an epoxy-based coating made in a cathodic electro-deposition (CED) process.

CED is a high-quality dip-painting process where an electrical field around the products ensures deposition of paint particles as a thin, well-controlled layer on the surface.

An integral part of the process is a pretreatment.

The entire process consists of these elements:

- 1) Alkaline-based cleaning.
- 2) Zinc phosphating.
- 3) Cathodic electro-deposition.
- 4) Curing to a dry film thickness 18-22 my m.

The colour code for the finished product is NCS 9000/RAL 9005.

Pump

A long split coupling connects the pump and motor shaft. It is enclosed in the motor stool by means of two coupling guards. The long coupling makes it possible to replace the shaft seal without removing the motor from the pump.

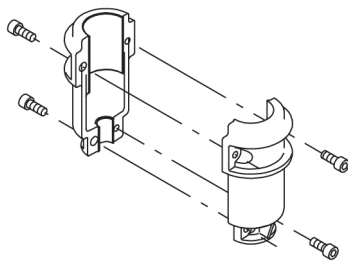

The pump head and flange for motor mounting is made in one piece (cast iron). The pump head cover is a separate component (stainless steel). The pump head has a combined 1/2" priming plug and vent screw.

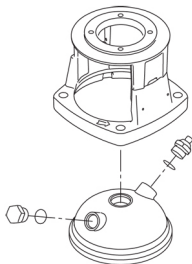

The pump is fitted with a balanced O-ring seal unit with a rigid torque-transmission system.

This seal type is assembled in a cartridge unit which makes replacement safe and easy.

Due to the balancing, this seal type is suitable for high-pressure applications.

The cartridge construction also protects the pump shaft from possible wear from a dynamic O-ring between pump shaft and shaft seal.

Seal faces:

- Rotating seal ring material: silicon carbide (SiC)
- Stationary seat material: silicon carbide (SiC)

This material pairing is used where higher corrosion resistance is required. The high hardness of this material pairing offers good resistance against abrasive particles.

Secondary seal material: EPDM (ethylene-propylene rubber)

EPDM has excellent resistance to hot water. EPDM is not suitable for mineral oils.

Qty. Description

1

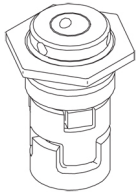

The shaft seal is screwed into the pump head.

The chambers and impellers are made of stainless-steel sheet. The chambers are provided with a PTFE neck ring offering improved sealing and high efficiency. The impellers have smooth surfaces, and the shape of the blades ensure a high efficiency.

The pump has a stainless steel base mounted on a separate base plate.

This base and base plate are kept in position by the tension of the staybolts which hold the pump together.

The outlet side of the base has a combined drain plug and bypass valve.

The pump is secured to the foundation by four bolts through the base plate.

The flanges and base are cast in one piece and prepared for connection by means of DIN, ANSI or JIS.

Motor

The motor is a totally enclosed, fan-cooled motor with principal dimensions to IEC and DIN standards. The motor is flange-mounted with free-hole flange (FF).

Motor-mounting designation in accordance with IEC 60034-7: IM B 5 (Code I) / IM 3001 (Code II).

Electrical tolerances comply with IEC 60034.

The motor efficiency is classified as IE5 in accordance with IEC 60034-30-2.

The motor requires no external motor protection. The motor control unit incorporates protection against slow- and quick-rising temperatures, e.g. constant overload and stalled conditions.

Technical data

Liquid:

Pumped liquid: Water
 Liquid temperature range: -20 .. 120 °C
 Selected liquid temperature: 20 °C
 Density: 998.2 kg/m³

Technical:

Pump speed on which pump data are based: 3529 rpm
 Rated flow: 12.1 m³/h
 Rated head: 204.2 m
 Pump orientation: Vertical
 Shaft seal arrangement: Single
 Code for shaft seal: HQQE
 Approvals: CE,EAC,UKCA,SEPRO
 Approvals for drinking water: WRAS,ACS
 Curve tolerance: ISO9906:2012 3B

Materials:

Base: Stainless steel
 EN 1.4408
 AISI 316
 Impeller: Stainless steel
 EN 1.4301
 AISI 304
 Bearing: SIC

Installation:

t max amb: 50 °C
 Maximum operating pressure: 25 bar
 Max pressure at stated temp: 25 bar / 120 °C

Qty. Description

| | |
|---|--|
| 1 | <p>25 bar / -20 °C</p> <p>Type of connection: DIN / ANSI / JIS</p> <p>Size of inlet connection: DN 40</p> <p>Size of outlet connection: DN 40</p> <p>Pressure rating for connection: PN 25</p> <p>Flange rating inlet: 300 lb</p> <p>Flange size for motor: FF300</p> <p>Electrical data:</p> <p>Motor standard: IEC</p> <p>Motor type: 160MH</p> <p>IE Efficiency class: IE5</p> <p>Rated power - P2: 11 kW</p> <p>Power (P2) required by pump: 11 kW</p> <p>Over/undersize motor: Standard motor size</p> <p>Mains frequency: 50 / 60 Hz</p> <p>Rated voltage: 3 x 380-500 V</p> <p>Rated current: 20.3-16.0 A</p> <p>Cos phi - power factor: 0.93-0.90</p> <p>Rated speed: 360-4000 rpm</p> <p>Efficiency: 93.1%</p> <p>Motor efficiency at full load: 93.1 %</p> <p>Enclosure class (IEC 34-5): IP55</p> <p>Insulation class (IEC 85): F</p> <p>Motor No: 98971053</p> <p>Controls:</p> <p>Frequency converter: Built-in</p> <p>Pressure sensor: Y</p> <p>Others:</p> <p>Minimum efficiency index, MEI ≥: 0.70</p> <p>Net weight: 125 kg</p> <p>Gross weight: 156 kg</p> <p>Shipping volume: 0.619 m³</p> <p>Country of origin: GB</p> <p>Custom tariff no.: 84137075</p> |
|---|--|

99071810 CRIE 10-17 N-FGJ-A-E-HQQE

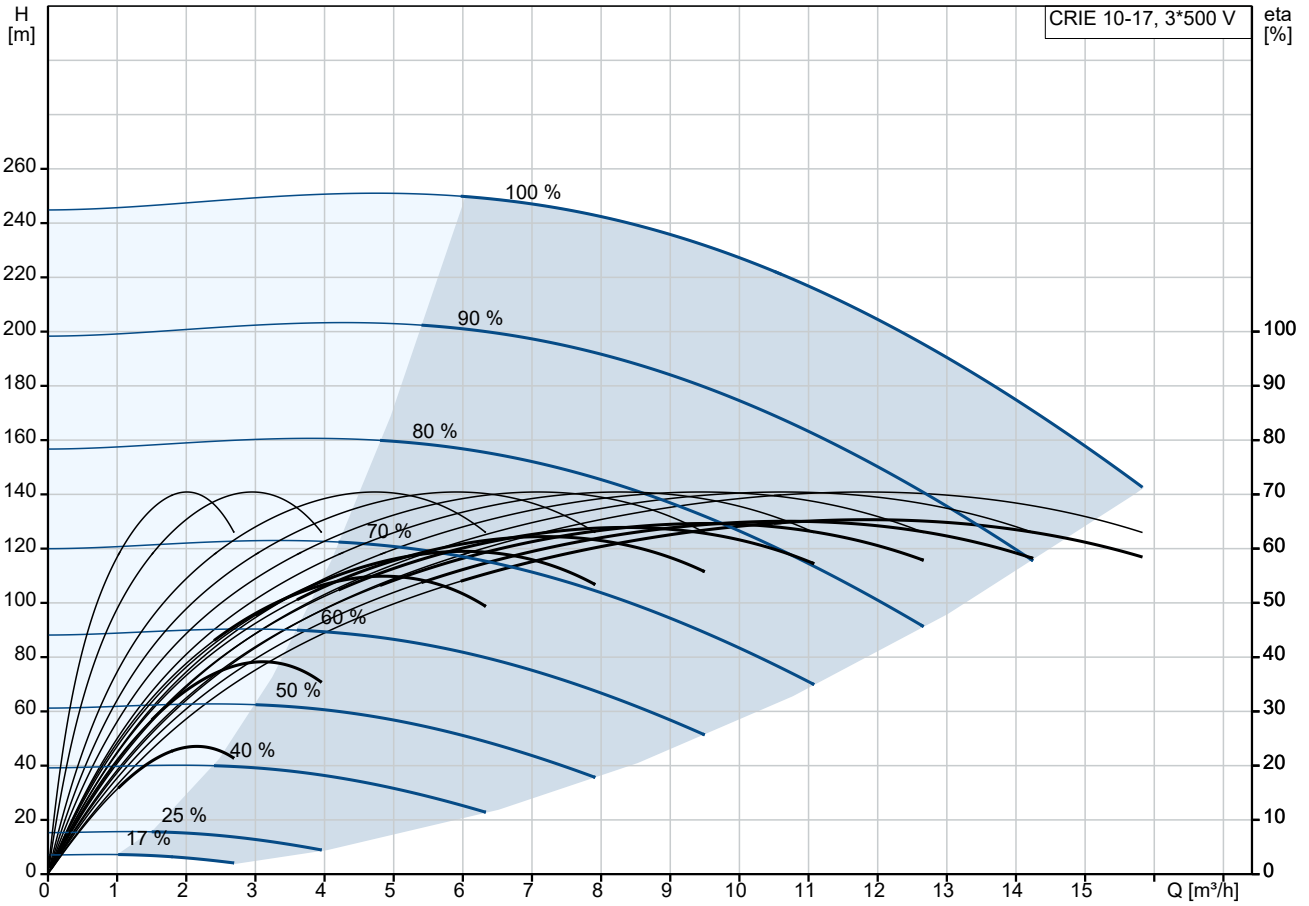

Pumped liquid = Water
Liquid temperature during operation = 20 °C
Density = 998.2 kg/m³

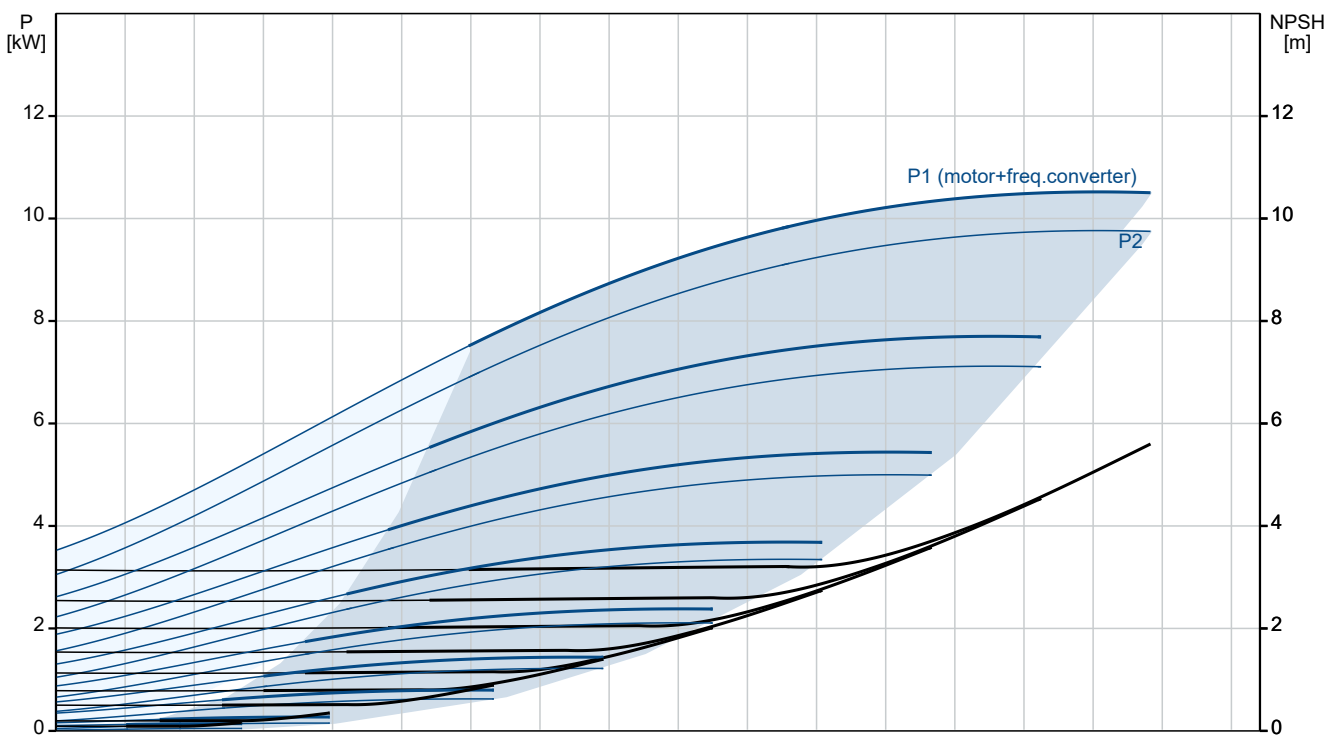

| Description | Value |
|--|------------------------------|
| General information: | |
| Product name: | CRIE 10-17 N-FGJ-A-E-HQQE |
| Product No: | 99071810 |
| EAN number: | 5712606198405 |
| Technical: | |
| Pump speed on which pump data are based: | 3529 rpm |
| Rated flow: | 12.1 m ³ /h |
| Rated head: | 204.2 m |
| Maximum head: | 252 m |
| Stages: | 18 |
| Impellers: | 17 |
| Number of reduced-diameter impellers: | 0 |
| Low NPSH: | N |
| Pump orientation: | Vertical |
| Shaft seal arrangement: | Single |
| Code for shaft seal: | HQQE |
| Approvals: | CE,EAC,UKCA,SEPRO |
| Approvals for drinking water: | WRAS,ACS |
| Curve tolerance: | ISO9906:2012 3B |
| Pump version: | N |
| Model: | A |
| Materials: | |
| Base: | Stainless steel |
| Base: | EN 1.4408 |
| Base: | AISI 316 |
| Impeller: | Stainless steel |
| Impeller: | EN 1.4301 |
| Impeller: | AISI 304 |
| Material code: | A |
| Code for rubber: | E |
| Bearing: | SIC |
| Installation: | |
| t max amb: | 50 °C |
| Maximum operating pressure: | 25 bar |
| Max pressure at stated temp: | 25 bar / 120 °C |
| Max pressure at stated temp: | 25 bar / -20 °C |
| Type of connection: | DIN / ANSI / JIS |
| Size of inlet connection: | DN 40 |
| Size of outlet connection: | DN 40 |
| Pressure rating for connection: | PN 25 |
| Flange rating inlet: | 300 lb |
| Flange size for motor: | FF300 |
| Connect code: | FGJ |
| Liquid: | |
| Pumped liquid: | Water |
| Liquid temperature range: | -20 .. 120 °C |
| Selected liquid temperature: | 20 °C |
| Density: | 998.2 kg/m ³ |
| Electrical data: | |
| Motor standard: | IEC |
| Motor type: | 160MH |
| IE Efficiency class: | IE5 |
| Rated power - P2: | 11 kW |
| Power (P2) required by pump: | 11 kW |
| Over/undersize motor: | Standard motor size |
| Mains frequency: | 50 / 60 Hz |

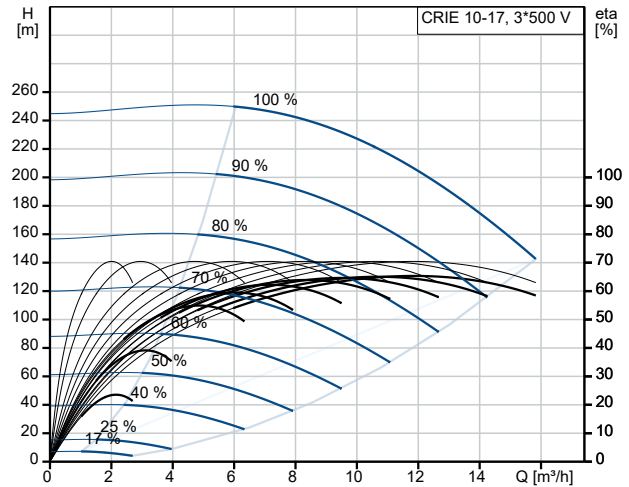

Pumped liquid = Water
Liquid temperature during operation = 20 °C
Density = 998.2 kg/m³

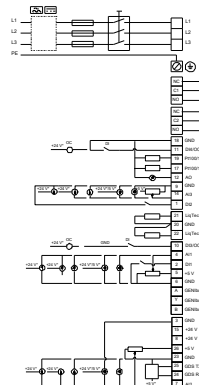
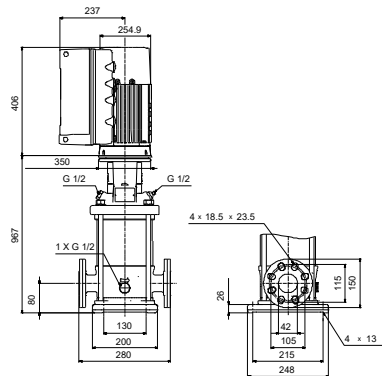
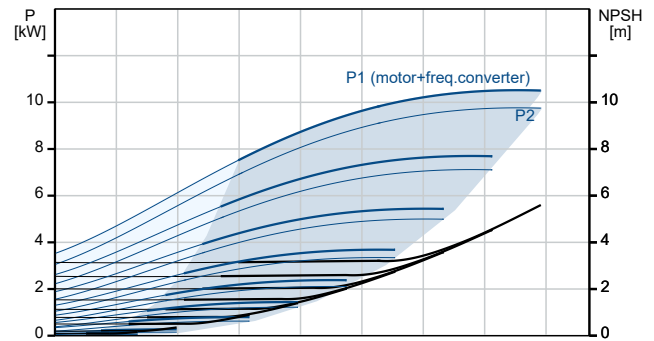



Company name:

Created by:

Phone:

Date:

02/01/2023

| Description | Value |
|----------------------------------|----------------------|
| Rated voltage: | 3 x 380-500 V |
| Rated current: | 20.3-16.0 A |
| Cos phi - power factor: | 0.93-0.90 |
| Rated speed: | 360-4000 rpm |
| Efficiency: | 93.1% |
| Motor efficiency at full load: | 93.1 % |
| Enclosure class (IEC 34-5): | IP55 |
| Insulation class (IEC 85): | F |
| Built-in motor protection: | ELEC |
| Motor No: | 98971053 |
| Controls: | |
| Control panel: | Standard |
| Function Module: | FM300 - Advanced |
| Frequency converter: | Built-in |
| Pressure sensor: | Y |
| Others: | |
| Minimum efficiency index, MEI ≥: | 0.70 |
| Net weight: | 125 kg |
| Gross weight: | 156 kg |
| Shipping volume: | 0.619 m ³ |
| Config. file no: | 99059021 |
| Country of origin: | GB |
| Custom tariff no.: | 84137075 |

99071810 CRIE 10-17 N-FGJ-A-E-HQQE

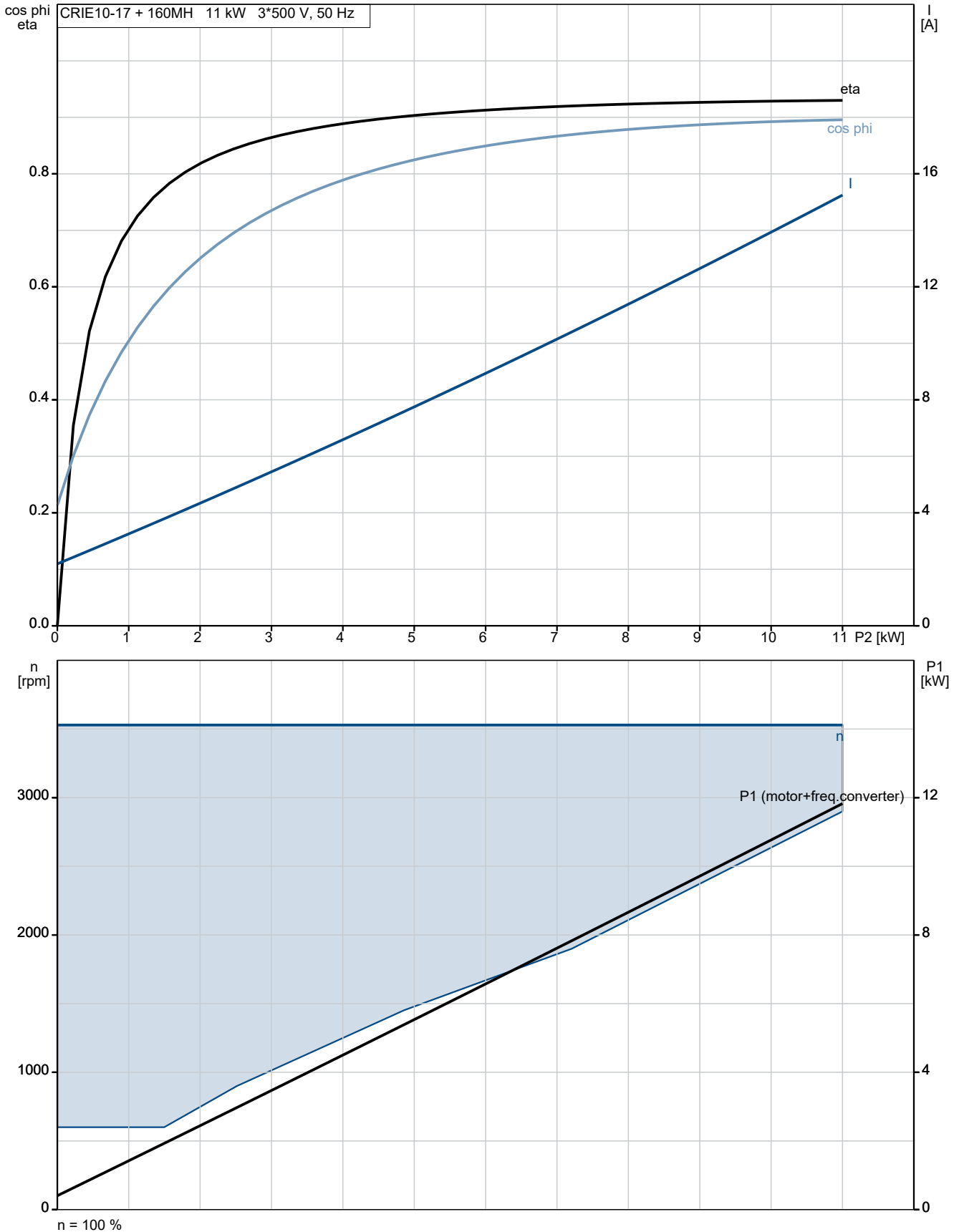

99071810 CRIE 10-17 N-FGJ-A-E-HQQE



Note! All units are in [mm] unless others are stated.

