

**Qty. Description**1 **CR 125-2 A-F-A-V-HQQV**

Note! Product picture may differ from actual product

Product No.: [99142634](#)

Vertical, multistage centrifugal pump with inlet and outlet ports on same the level (inline). The pump head and base are in cast iron – all other wetted parts are in stainless steel. The Grundfos cartridge shaft seal ensures high reliability, safe handling, and easy access and service. Power transmission is via a rigid split coupling. Pipe connection is via DIN flanges.

The pump is fitted with a 3-phase, fan-cooled asynchronous motor.

**Further product details**

Steel, cast iron and aluminium components have an epoxy-based coating made in a cathodic electro-deposition (CED) process.

CED is a high-quality dip-painting process where an electrical field around the products ensures deposition of paint particles as a thin, well-controlled layer on the surface.

An integral part of the process is a pretreatment.

The entire process consists of these elements:

- 1) Alkaline-based cleaning.
- 2) Zinc phosphating.
- 3) Cathodic electro-deposition.
- 4) Curing to a dry film thickness 18-22 my m.

The colour code for the finished product is NCS 9000/RAL 9005.

**Pump**

A long split coupling connects the pump and motor shaft. It is enclosed in the motor stool by means of two coupling guards. The long coupling makes it possible to replace the shaft seal without removing the motor from the pump.

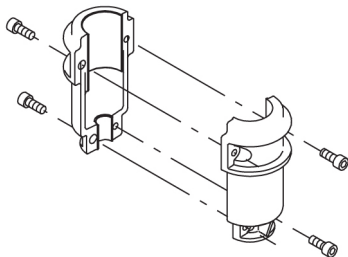

The motor stool connects the pump head and motor. The pump head has a combined 1/2" priming plug and vent screw.

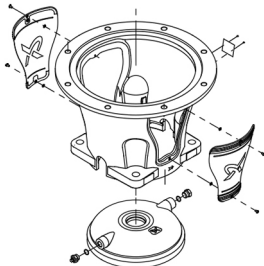

The pump is fitted with a balanced O-ring seal unit with a rigid torque-transmission system.

This seal type is assembled in a cartridge unit which makes replacement safe and easy.

Due to the balancing, this seal type is suitable for high-pressure applications.

The cartridge construction also protects the pump shaft from possible wear from a dynamic O-ring between pump shaft and shaft seal.

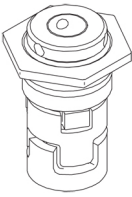
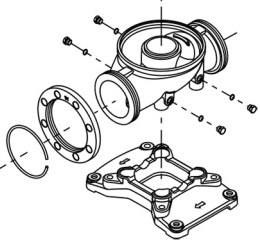
Qty.	Description																										
1	<p data-bbox="199 159 327 188">Seal faces:</p> <ul data-bbox="239 190 790 250" style="list-style-type: none"> <li>• Rotating seal ring material: silicon carbide (SiC)</li> <li>• Stationary seat material: silicon carbide (SiC)</li> </ul> <p data-bbox="199 250 1452 304">This material pairing is used where higher corrosion resistance is required. The high hardness of this material pairing offers good resistance against abrasive particles.</p> <p data-bbox="199 306 762 336">Secondary seal material: FKM (fluorocarbon rubber)</p> <p data-bbox="199 338 1439 367">FKM has excellent resistance to oils and chemicals. Above 90 °C, FKM should only be used in media without water.</p>  <p data-bbox="199 613 697 642">The shaft seal is screwed into the pump head.</p> <p data-bbox="199 645 1425 721">The chambers and impellers are made of stainless-steel sheet. The chambers are provided with a PEEK neck ring offering improved sealing and high efficiency. The impellers have smooth surfaces, and the shape of the blades ensure a high efficiency.</p> <p data-bbox="199 757 1046 786">The base is made of cast iron and mounted on a separate cast-iron base plate.</p> <p data-bbox="199 788 1054 817">Both the inlet and the outlet side of the base have two pressure gauge tapings.</p> <p data-bbox="199 819 1007 848">The pump is secured to the foundation by four bolts through the base plate.</p> <p data-bbox="199 851 882 880">The flanges are fastened to the base by means of locking rings.</p>  <p data-bbox="199 1184 284 1214"><b>Motor</b></p> <p data-bbox="199 1220 1431 1274">The motor is a totally enclosed, fan-cooled motor with principal dimensions to IEC and DIN standards. The motor is flange-mounted with free-hole flange (FF).</p> <p data-bbox="199 1276 1243 1305">Motor-mounting designation in accordance with IEC 60034-7: IM B 5 (Code I) / IM 3001 (Code II).</p> <p data-bbox="199 1308 679 1337">Electrical tolerances comply with IEC 60034.</p> <p data-bbox="199 1339 1016 1368">The motor efficiency is classified as IE3 in accordance with IEC 60034-30-1.</p> <p data-bbox="199 1370 1434 1424">The motor has thermistors (PTC sensors) in the windings in accordance with DIN 44081/DIN 44082. The protection reacts to both slow- and quick-rising temperatures, e.g. constant overload and stalled conditions.</p> <p data-bbox="199 1426 1422 1503">Thermal switches must be connected to an external control circuit in a way which ensures that the automatic reset cannot cause accidents. The motors must be connected to a motor-protective circuit breaker according to local regulations.</p> <p data-bbox="199 1505 1406 1559">The motor can be connected to a variable speed drive for adjustment of pump performance to any duty point. Grundfos CUE offers a range of variable speed drives. Please find more information in Grundfos Product Center.</p> <p data-bbox="199 1568 400 1597"><b>Technical data</b></p> <table data-bbox="199 1662 697 1809"> <tr> <td>Liquid:</td> <td></td> </tr> <tr> <td>Pumped liquid:</td> <td>Water</td> </tr> <tr> <td>Liquid temperature range:</td> <td>-20 .. 90 °C</td> </tr> <tr> <td>Selected liquid temperature:</td> <td>20 °C</td> </tr> <tr> <td>Density:</td> <td>998.2 kg/m<sup>3</sup></td> </tr> </table> <table data-bbox="199 1841 821 2078"> <tr> <td>Technical:</td> <td></td> </tr> <tr> <td>Pump speed on which pump data are based:</td> <td>2961 rpm</td> </tr> <tr> <td>Rated flow:</td> <td>125 m<sup>3</sup>/h</td> </tr> <tr> <td>Rated head:</td> <td>51.3 m</td> </tr> <tr> <td>Pump orientation:</td> <td>Vertical</td> </tr> <tr> <td>Shaft seal arrangement:</td> <td>Single</td> </tr> <tr> <td>Code for shaft seal:</td> <td>HQQV</td> </tr> <tr> <td>Approvals and markings:</td> <td>CE,EAC,UKCA,SEPRO</td> </tr> </table>	Liquid:		Pumped liquid:	Water	Liquid temperature range:	-20 .. 90 °C	Selected liquid temperature:	20 °C	Density:	998.2 kg/m <sup>3</sup>	Technical:		Pump speed on which pump data are based:	2961 rpm	Rated flow:	125 m <sup>3</sup> /h	Rated head:	51.3 m	Pump orientation:	Vertical	Shaft seal arrangement:	Single	Code for shaft seal:	HQQV	Approvals and markings:	CE,EAC,UKCA,SEPRO
Liquid:																											
Pumped liquid:	Water																										
Liquid temperature range:	-20 .. 90 °C																										
Selected liquid temperature:	20 °C																										
Density:	998.2 kg/m <sup>3</sup>																										
Technical:																											
Pump speed on which pump data are based:	2961 rpm																										
Rated flow:	125 m <sup>3</sup> /h																										
Rated head:	51.3 m																										
Pump orientation:	Vertical																										
Shaft seal arrangement:	Single																										
Code for shaft seal:	HQQV																										
Approvals and markings:	CE,EAC,UKCA,SEPRO																										

Qty.	Description
1	<p>Approvals for drinking water: ACS Curve tolerance: ISO9906:2012 3B</p> <p>Materials: Base: Ductile cast iron EN 1563 EN-GJS-500-7 ASTM A536-84 65-45-12</p> <p>Impeller: Stainless steel EN 1.4301 AISI 304</p> <p>Bearing arrangement: WC/WC Support bearing: Graflon Material certified according to: European standards</p> <p>Installation: t max amb: 60 °C Maximum operating pressure: 16 bar Max pressure at stated temp: 16 bar / 90 °C Type of connection: DIN Size of inlet connection: DN 150 Size of outlet connection: DN 150 Pressure rating for connection: PN 16 Flange size for motor: FF300</p> <p>Electrical data: Motor standard: IEC Motor type: 180MB IE Efficiency class: IE3 Rated power - P2: 22 kW Power (P2) required by pump: 22 kW Mains frequency: 50 Hz Rated voltage: 3 x 380-415D/660-690Y V Rated current: 39.5/22.8 A Starting current: 830 % Cos phi - power factor: 0.90-0.90 Rated speed: 2950 rpm Efficiency: IE3 92,7% Motor efficiency at full load: 92.7-92.7 % Motor efficiency at 3/4 load: 93.7 % Motor efficiency at 1/2 load: 94.4 % Number of poles: 2 Enclosure class (IEC 34-5): 55 Dust/Jetting Insulation class (IEC 85): F Motor No: 85U17530</p> <p>Controls: Frequency converter: NONE</p> <p>Others: Minimum efficiency index, MEI ≥: 0.70 Net weight: 283 kg Gross weight: 347 kg Shipping volume: 1.14 m<sup>3</sup> Thrust handling device: N Country of origin: DK Custom tariff no.: 84137075</p>

# 99142634 CR 125-2 A-F-A-V-HQQV 50 Hz

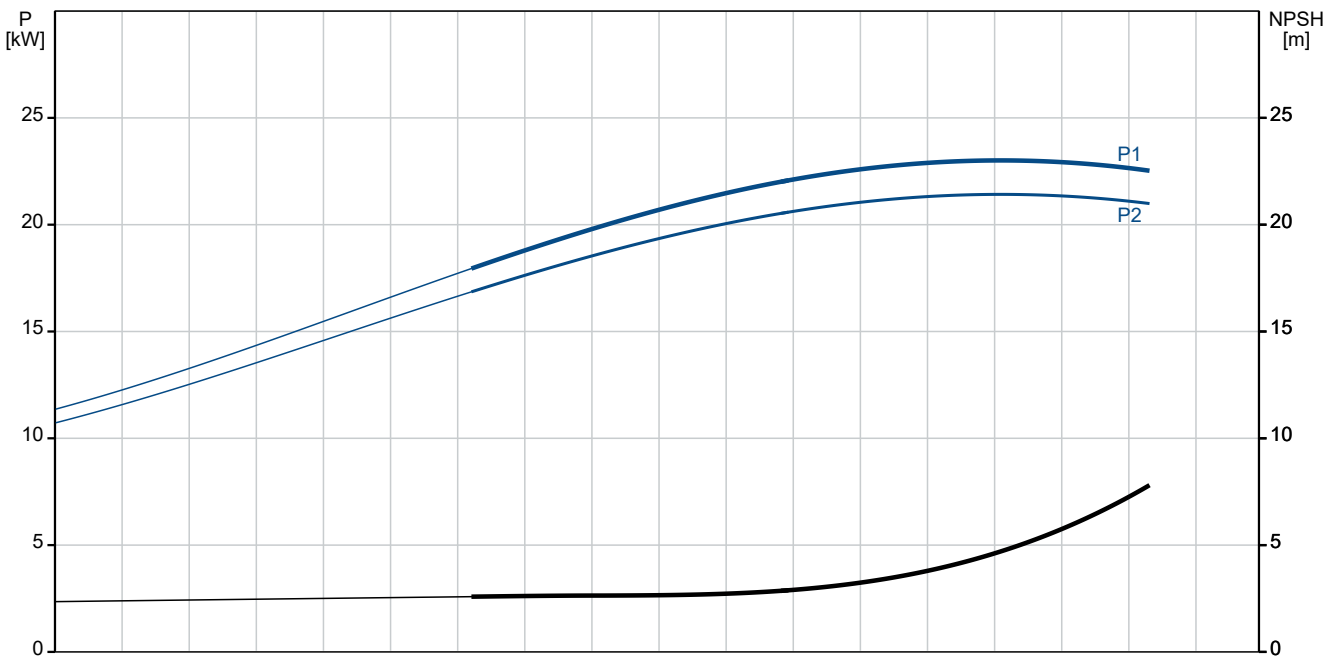
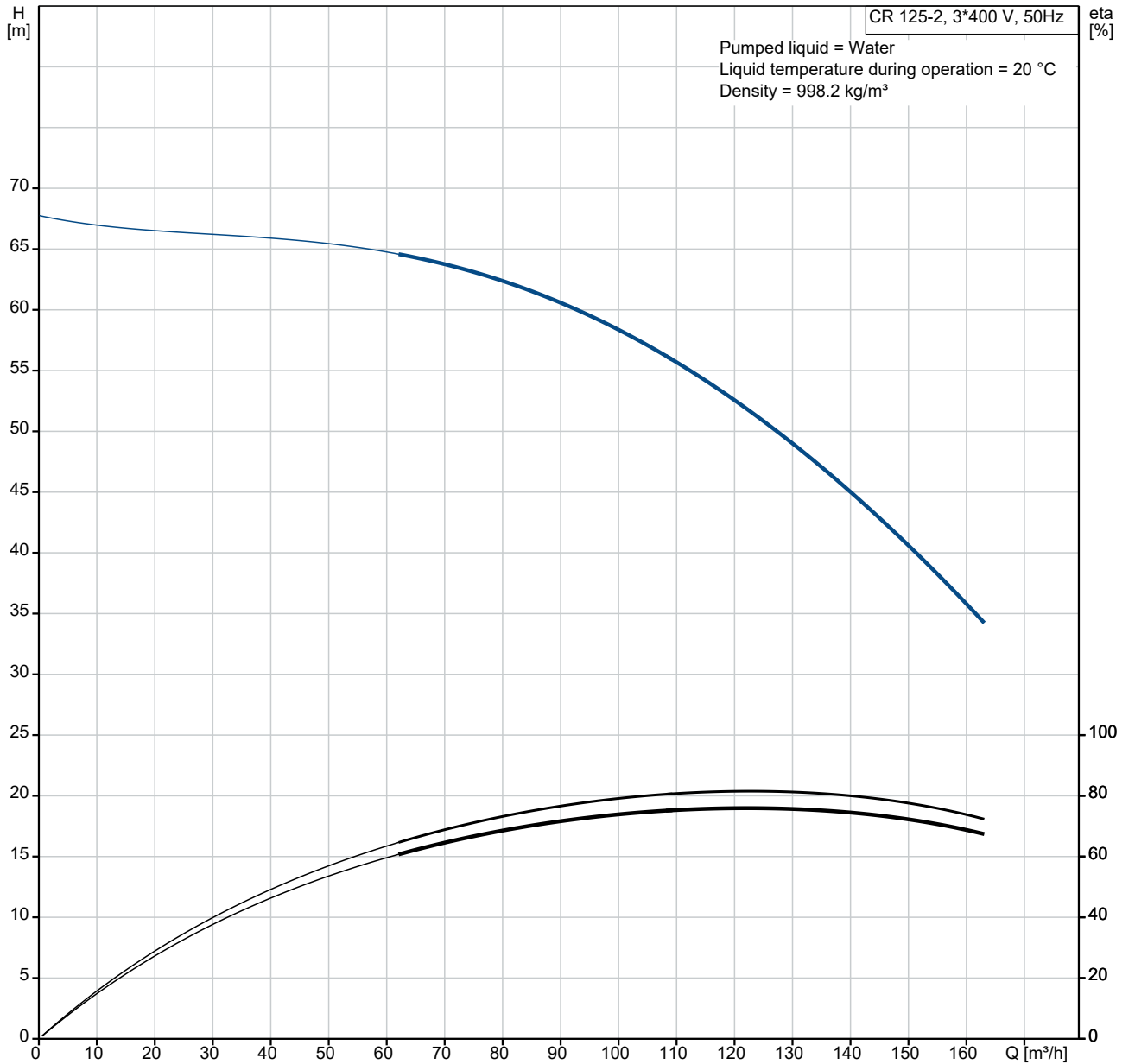

Description	Value
<b>General information:</b>	
Product name:	CR 125-2 A-F-A-V-HQQV
Product No:	99142634
EAN number:	5712607541354
<b>Technical:</b>	
Pump speed on which pump data are based:	2961 rpm
Rated flow:	125 m <sup>3</sup> /h
Rated head:	51.3 m
Maximum head:	67.9 m
Number of stages:	2
Impellers:	2
Number of reduced-diameter impellers:	0
Low NPSH:	N
Pump orientation:	Vertical
Shaft seal arrangement:	Single
Code for shaft seal:	HQQV
Approvals and markings:	CE,EAC,UKCA,SEPRO
Approvals for drinking water:	ACS
Curve tolerance:	ISO9906:2012 3B
Pump version:	A
The first model is called A which is followed by model B, C etc.:	A
Cooling according to IEC 34-6:	IC 411
<b>Materials:</b>	
Base:	Ductile cast iron
Base:	EN 1563 EN-GJS-500-7
Base:	ASTM A536-84 65-45-12
Impeller:	Stainless steel
Impeller:	EN 1.4301
Impeller:	AISI 304
Material code:	A
Code for rubber:	V
Bearing arrangement:	WC/WC
Support bearing:	Graflon
Material certified according to:	European standards
<b>Installation:</b>	
t max amb:	60 °C
Maximum operating pressure:	16 bar
Max pressure at stated temp:	16 bar / 90 °C
Type of connection:	DIN
Size of inlet connection:	DN 150
Size of outlet connection:	DN 150
Pressure rating for connection:	PN 16
Flange size for motor:	FF300
Connect code:	F
<b>Liquid:</b>	
Pumped liquid:	Water
Liquid temperature range:	-20 .. 90 °C
Selected liquid temperature:	20 °C
Density:	998.2 kg/m <sup>3</sup>
<b>Electrical data:</b>	
Motor standard:	IEC
Motor type:	180MB
IE Efficiency class:	IE3
Rated power - P2:	22 kW
Power (P2) required by pump:	22 kW
Mains frequency:	50 Hz
Rated voltage:	3 x 380-415D/660-690Y V
Rated current:	39.5/22.8 A

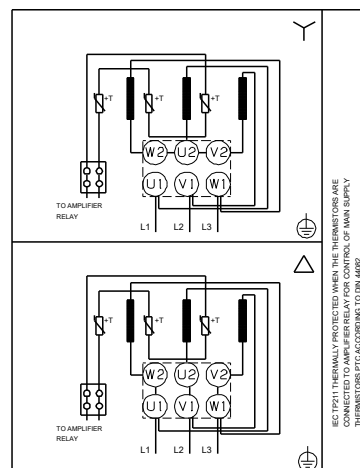
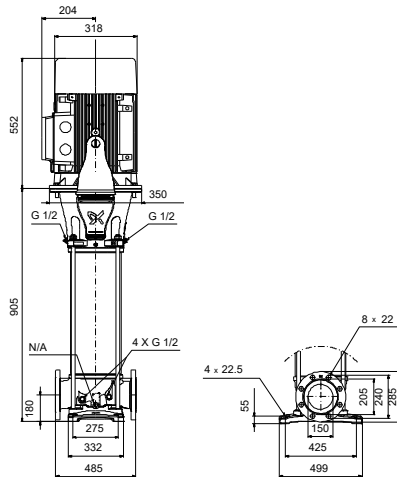
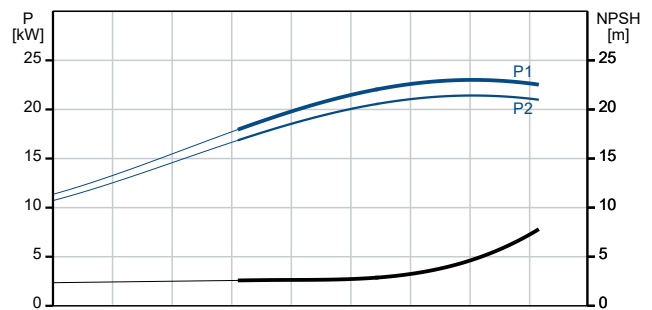
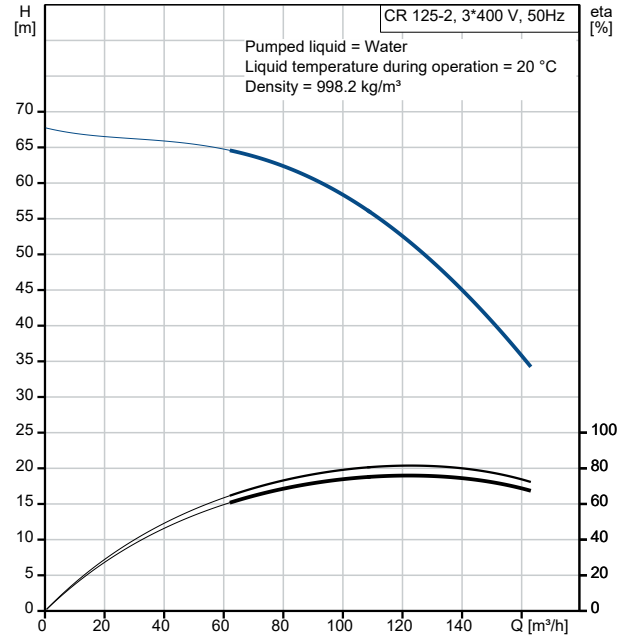

Description	Value
Starting current:	830 %
Cos phi - power factor:	0.90-0.90
Rated speed:	2950 rpm
Efficiency:	IE3 92,7%
Motor efficiency at full load:	92.7-92.7 %
Motor efficiency at 3/4 load:	93.7 %
Motor efficiency at 1/2 load:	94.4 %
Number of poles:	2
Enclosure class (IEC 34-5):	55 Dust/Jetting
Insulation class (IEC 85):	F
Built-in motor protection:	PTC
Motor No:	85U17530
<b>Controls:</b>	
Frequency converter:	NONE
<b>Others:</b>	
Minimum efficiency index, MEI ≥:	0.70
Net weight:	283 kg
Gross weight:	347 kg
Shipping volume:	1.14 m <sup>3</sup>
Thrust handling device:	N
Country of origin:	DK
Custom tariff no.:	84137075

# 99142634 CR 125-2 A-F-A-V-HQQV 50 Hz

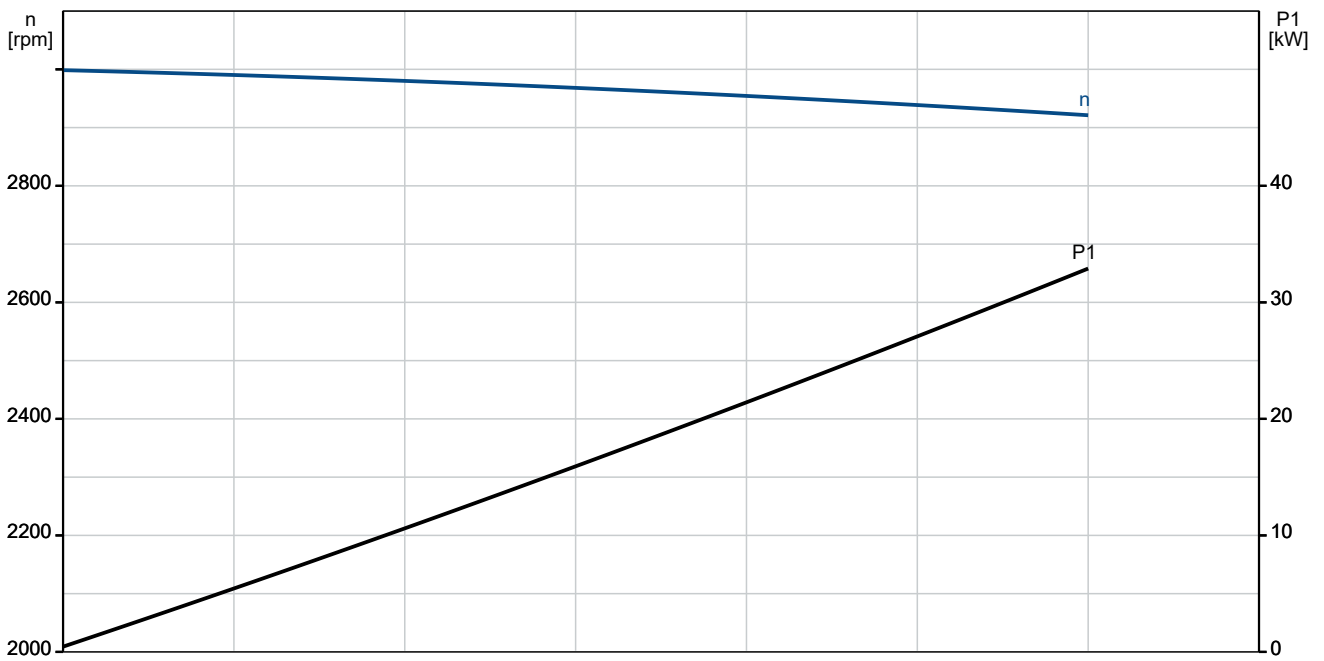
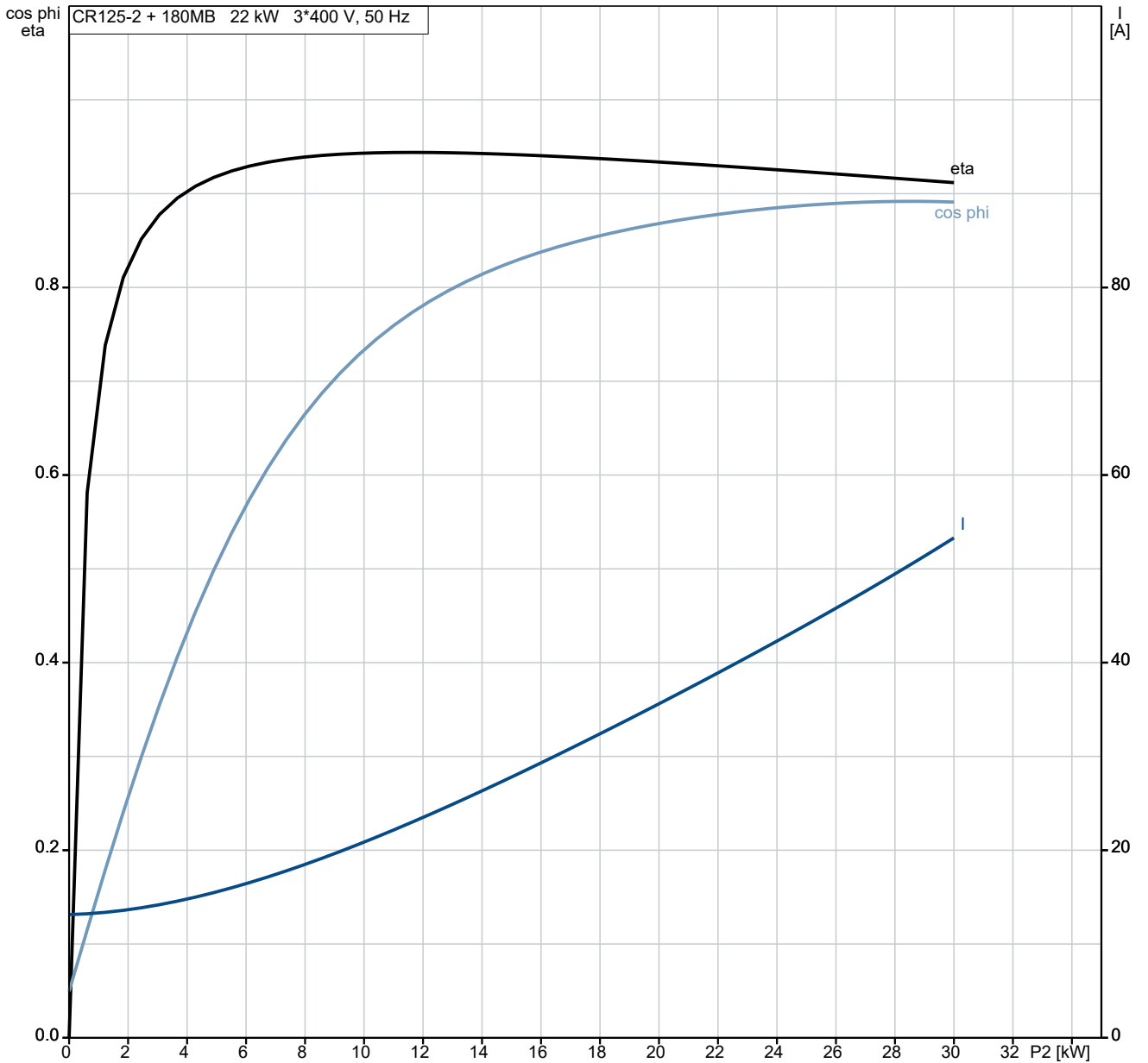

# 99142634 CR 125-2 A-F-A-V-HQQV 50 Hz

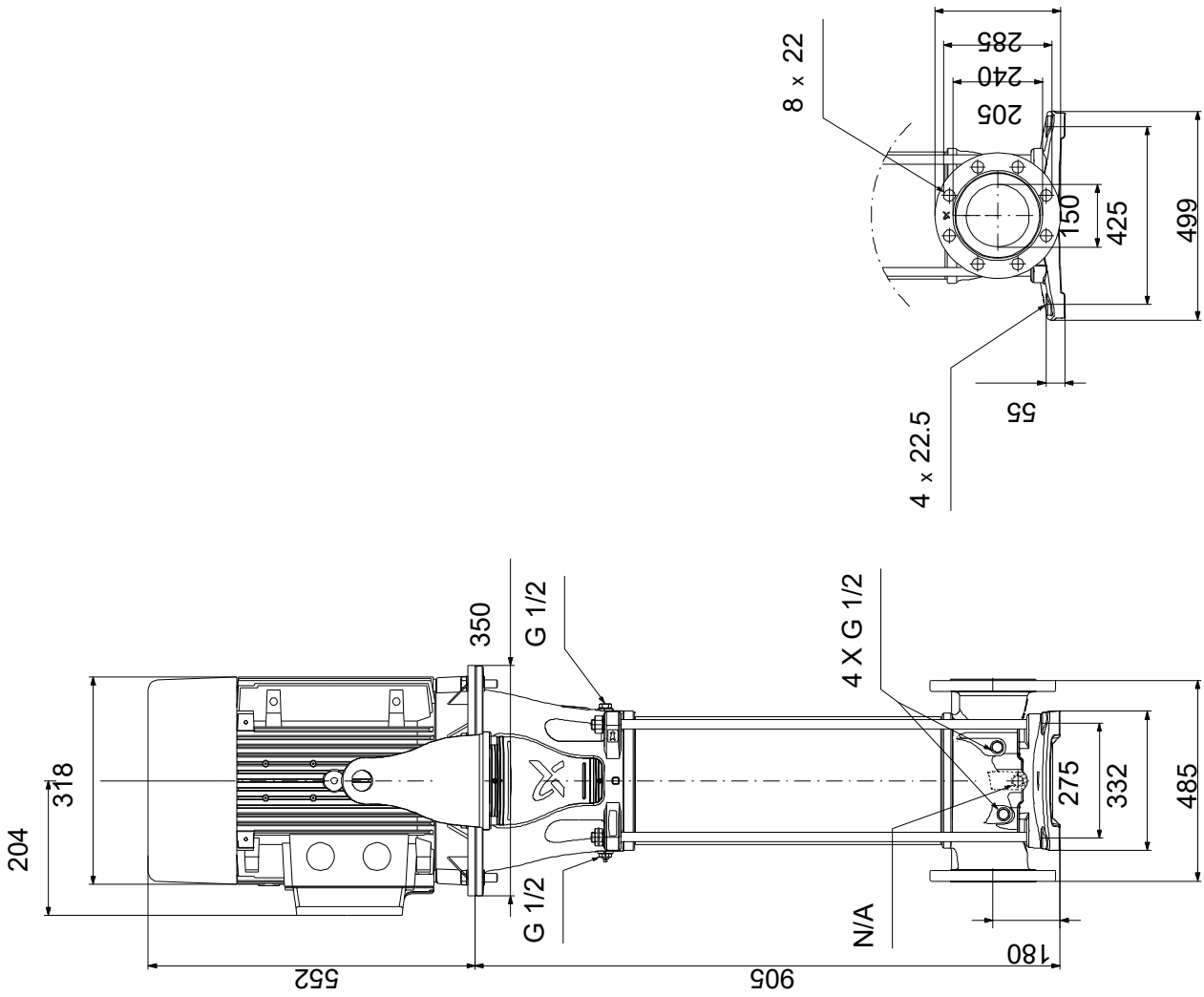

Note! All units are in [mm] unless others are stated.  
 Disclaimer: This simplified dimensional drawing does not show all details.

# 99142634 CR 125-2 A-F-A-V-HQQV 50 Hz

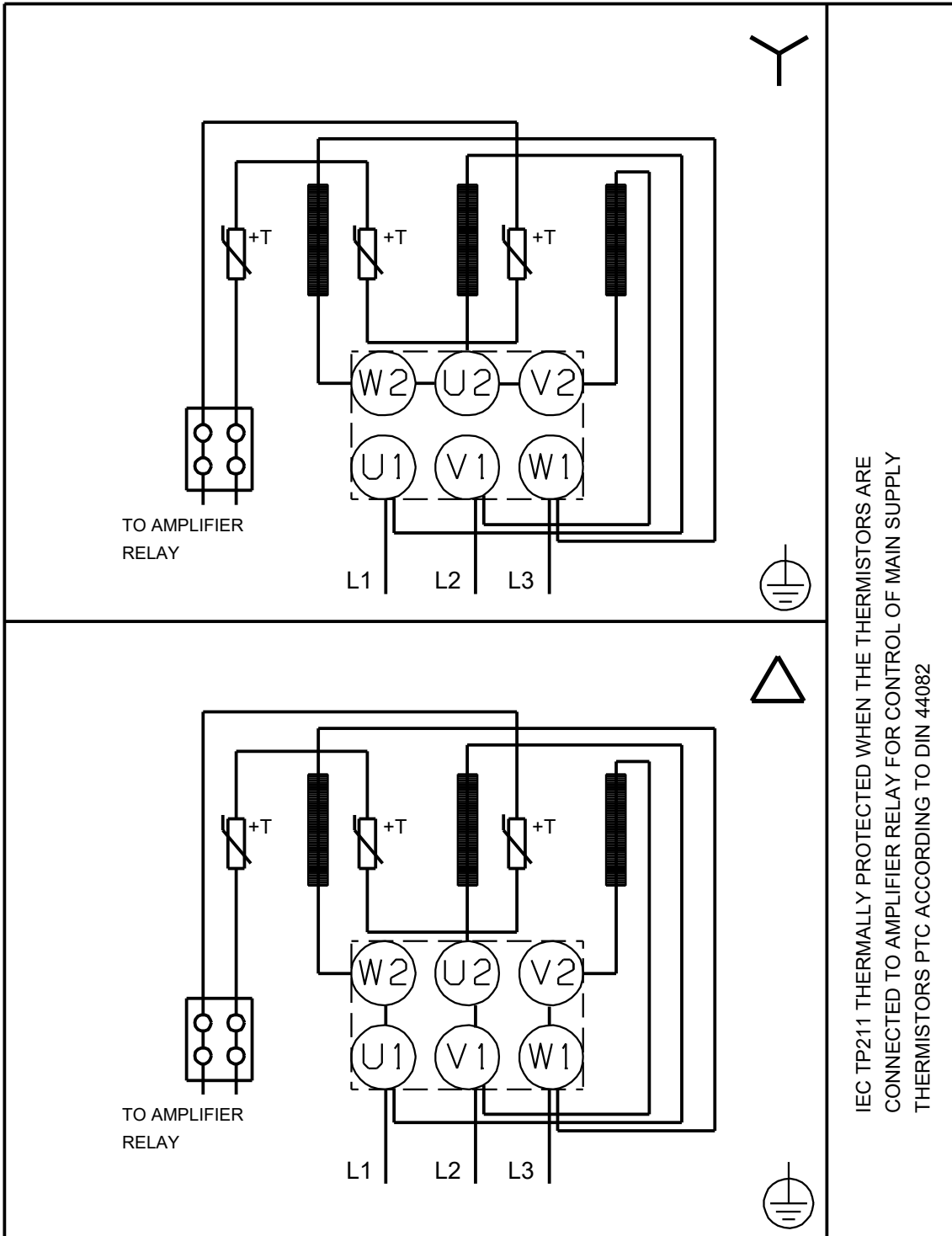

IEC TP211 THERMALLY PROTECTED WHEN THE THERMISTORS ARE  
 CONNECTED TO AMPLIFIER RELAY FOR CONTROL OF MAIN SUPPLY  
 THERMISTORS PTC ACCORDING TO DIN 44082

Note! All units are in [mm] unless others are stated.

