

Qty. Description

1 CRN 185-4-3 A-F-A-E-HQQE



Note! Product picture may differ from actual product

Product No.: [99143741](#)

Vertical, multistage centrifugal pump with inlet and outlet ports on same the level (inline). Pump materials in contact with the liquid are in high-grade stainless steel. A built-in thrust-handling device absorbs hydraulic axial forces which enables the use of a standard motor.

The Grundfos cartridge shaft seal ensures high reliability, safe handling, and easy access and service. Power transmission is via a rigid split coupling. Pipe connection is via DIN flanges.

The pump is fitted with a 3-phase, fan-cooled asynchronous motor.

Further product details

Steel, cast iron and aluminium components have an epoxy-based coating made in a cathodic electro-deposition (CED) process.

CED is a high-quality dip-painting process where an electrical field around the products ensures deposition of paint particles as a thin, well-controlled layer on the surface.

An integral part of the process is a pretreatment.

The entire process consists of these elements:

- 1) Alkaline-based cleaning.
- 2) Zinc phosphating.
- 3) Cathodic electro-deposition.
- 4) Curing to a dry film thickness 18-22 my m.

The colour code for the finished product is NCS 9000/RAL 9005.

Pump

A long split coupling connects the pump and motor shaft. It is enclosed in the motor stool by means of two coupling guards. The long coupling makes it possible to replace the shaft seal without removing the motor from the pump.

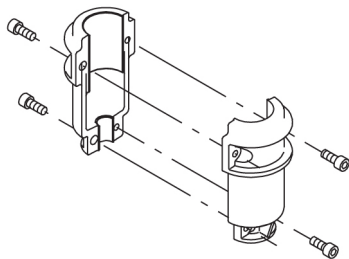

The motor stool connects the pump head and motor. The pump head has a combined 1/2" priming plug and vent screw.

Qty. Description

1

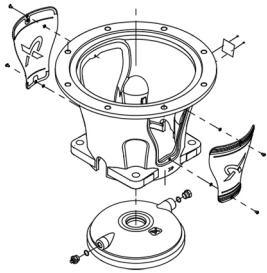

The pump is fitted with a balanced O-ring seal unit with a rigid torque-transmission system.

This seal type is assembled in a cartridge unit which makes replacement safe and easy.

Due to the balancing, this seal type is suitable for high-pressure applications.

The cartridge construction also protects the pump shaft from possible wear from a dynamic O-ring between pump shaft and shaft seal.

Seal faces:

- Rotating seal ring material: silicon carbide (SiC)
- Stationary seat material: silicon carbide (SiC)

This material pairing is used where higher corrosion resistance is required. The high hardness of this material pairing offers good resistance against abrasive particles.

Secondary seal material: EPDM (ethylene-propylene rubber)

EPDM has excellent resistance to hot water. EPDM is not suitable for mineral oils.

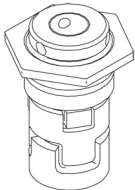

The shaft seal is screwed into the pump head.

The chambers and impellers are made of stainless-steel sheet. The chambers are provided with a PEEK neck ring offering improved sealing and high efficiency. The impellers have smooth surfaces, and the shape of the blades ensure a high efficiency.

The pump has a stainless-steel base mounted on a separate cast-iron base plate.

The base and base plate are kept in position by the tension of the staybolts which hold the pump together.

Both the inlet and the outlet side of the base have two pressure gauge tapings.

The pump is secured to the foundation by four bolts through the base plate.

The flanges are fastened to the base by means of locking rings.

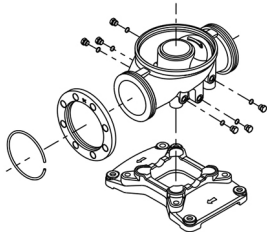
**Motor**

The motor is a totally enclosed, fan-cooled motor with principal dimensions to IEC and DIN standards. The motor is flange-mounted with free-hole flange (FF).

Motor-mounting designation in accordance with IEC 60034-7: IM B 5 (Code I) / IM 3001 (Code II).

Electrical tolerances comply with IEC 60034.

The motor efficiency is classified as IE3 in accordance with IEC 60034-30-1.

The motor has thermistors (PTC sensors) in the windings in accordance with DIN 44081/DIN 44082. The protection reacts to both slow- and quick-rising temperatures, e.g. constant overload and stalled conditions.

Qty.	Description
1	<p>Thermal switches must be connected to an external control circuit in a way which ensures that the automatic reset cannot cause accidents. The motors must be connected to a motor-protective circuit breaker according to local regulations.</p> <p>A variable speed drive makes adjustment of pump performance to any duty point possible. If the motor is to be connected to a variable speed drive, the pump must be ordered with an electrically insulated motor bearing.</p> <p>Technical data</p> <p>Liquid: Pumped liquid: Water Liquid temperature range: -20 .. 120 °C Selected liquid temperature: 20 °C Density: 998.2 kg/m³</p> <p>Technical: Pump speed on which pump data are based: 2975 rpm Rated flow: 185 m³/h Rated head: 121.1 m Pump orientation: Vertical Shaft seal arrangement: Single Code for shaft seal: HQQE Approvals: CE,EAC,UKCA,SEPRO Approvals for drinking water: ACS Curve tolerance: ISO9906:2012 3B</p> <p>Materials: Base: Stainless steel EN 1.4408 ASTM A351 CF8M Impeller: Stainless steel EN 1.4401 AISI 316 Bearing: WC/WC Support bearing: Graflon Thrust handling device: SiC/WC Material certified according to: European standards</p> <p>Installation: t max amb: 55 °C Maximum operating pressure: 25 bar Max pressure at stated temp: 25 bar / 120 °C Type of connection: DIN Size of inlet connection: DN 200 Size of outlet connection: DN 200 Pressure rating for connection: PN 25 Flange size for motor: FF500</p> <p>Electrical data: Motor standard: IEC Motor type: SIEMENS IE Efficiency class: IE3 Rated power - P2: 75 kW Power (P2) required by pump: 75 kW Mains frequency: 50 Hz Rated voltage: 3 x 380-420D/660-725Y V Rated current: 128/74 A Starting current: 680-680 % Cos phi - power factor: 0.89 Rated speed: 2975 rpm</p>



Company name:

Created by:

Phone:

Date:

30/11/2022

Qty. Description

1	Efficiency:	IE3 94,7%
	Motor efficiency at full load:	94.7-94.7 %
	Motor efficiency at 3/4 load:	94.8-94.8 %
	Motor efficiency at 1/2 load:	94.1-94.1 %
	Number of poles:	2
	Enclosure class (IEC 34-5):	IP55
	Insulation class (IEC 85):	F
	Motor No:	83U15240
	Controls:	
	Frequency converter:	NONE
	Others:	
	Minimum efficiency index, MEI \geq :	0.70
	Net weight:	855 kg
	Gross weight:	1020 kg
	Shipping volume:	2.48 m ³
	Thrust handling device:	Y



Company name:

Created by:

Phone:

Date:

30/11/2022

99143741 CRN 185-4-3 A-F-A-E-HQQE 50 Hz

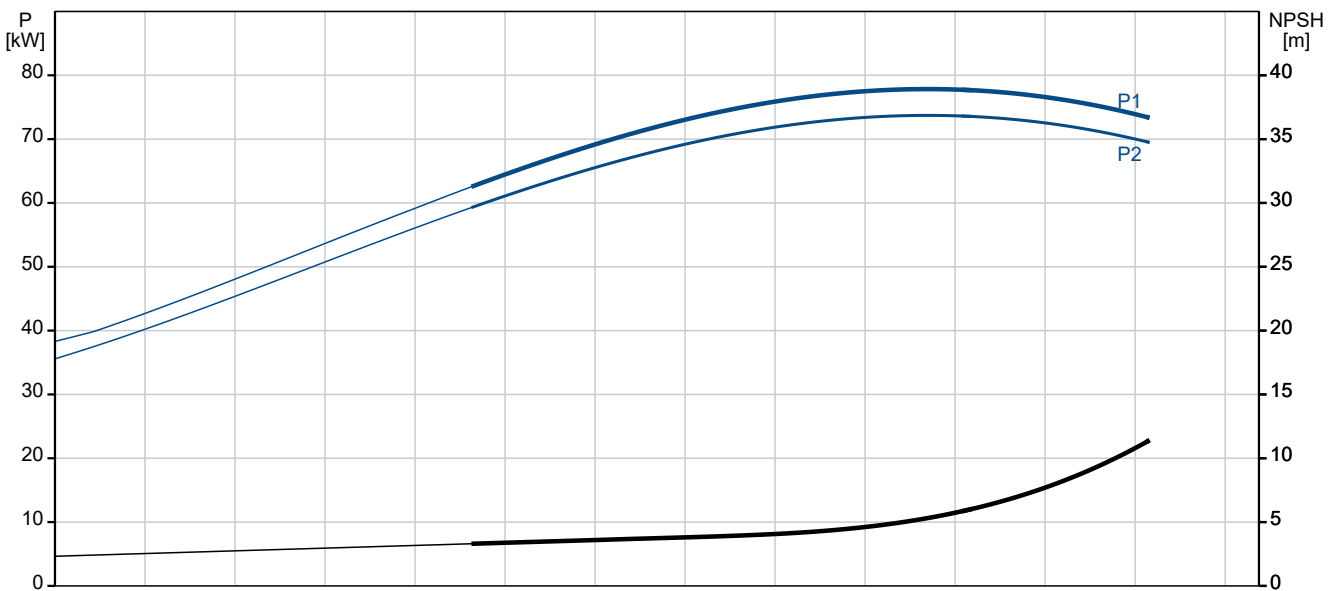
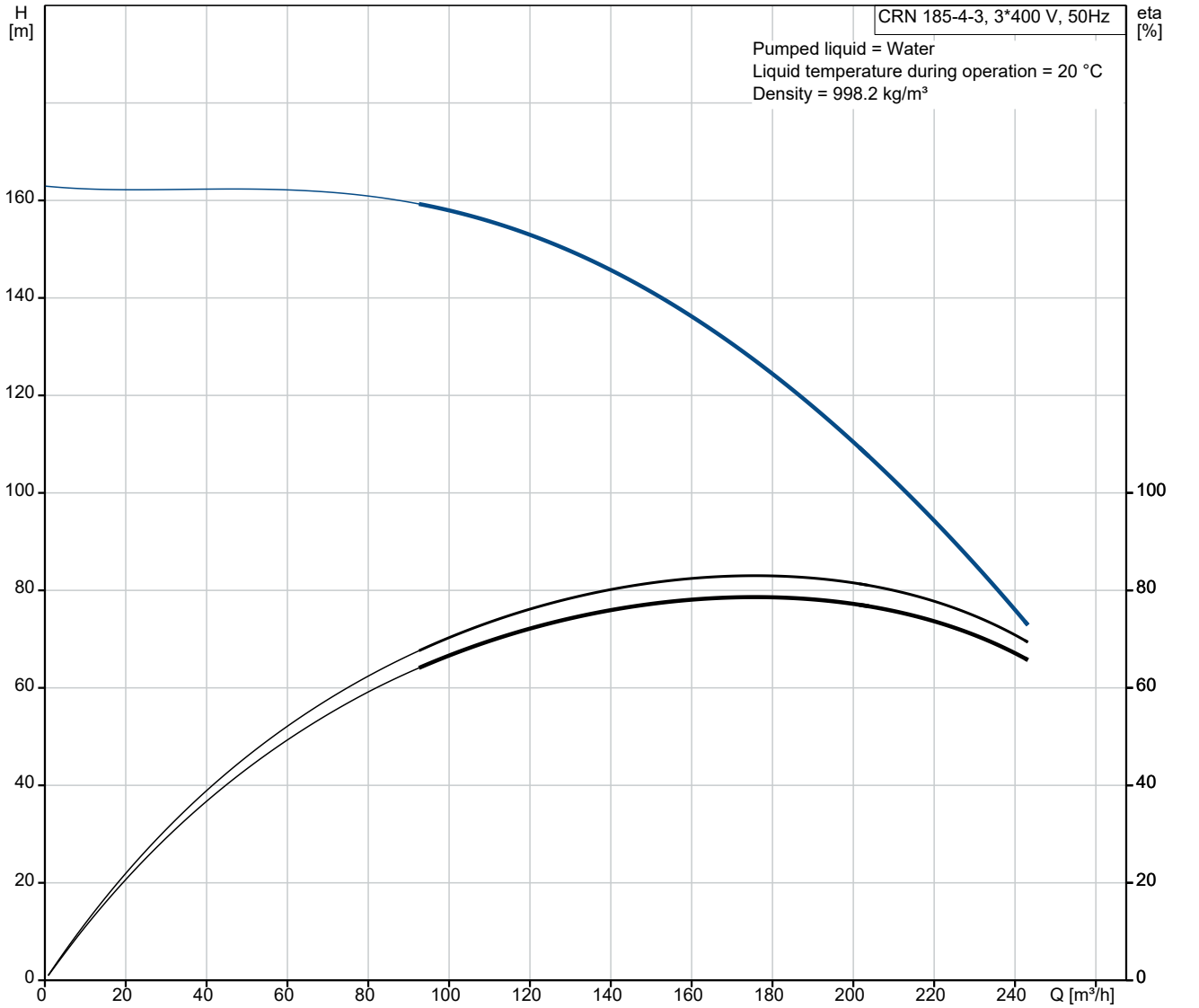

Description	Value
General information:	
Product name:	CRN 185-4-3 A-F-A-E-HQQE
Product No:	99143741
EAN number:	5712607562106
Technical:	
Pump speed on which pump data are based:	2975 rpm
Rated flow:	185 m ³ /h
Rated head:	121.1 m
Maximum head:	163 m
Stages:	4
Impellers:	4
Number of reduced-diameter impellers:	3
Low NPSH:	N
Pump orientation:	Vertical
Shaft seal arrangement:	Single
Code for shaft seal:	HQQE
Approvals:	CE,EAC,UKCA,SEPRO
Approvals for drinking water:	ACS
Curve tolerance:	ISO9906:2012 3B
Pump version:	A
Model:	A
Cooling:	IC 411
Materials:	
Base:	Stainless steel
Base:	EN 1.4408
Base:	ASTM A351 CF8M
Impeller:	Stainless steel
Impeller:	EN 1.4401
Impeller:	AISI 316
Material code:	A
Code for rubber:	E
Bearing:	WC/WC
Support bearing:	Graflon
Thrust handling device:	SiC/WC
Material certified according to:	European standards
Installation:	
t max amb:	55 °C
Maximum operating pressure:	25 bar
Max pressure at stated temp:	25 bar / 120 °C
Type of connection:	DIN
Size of inlet connection:	DN 200
Size of outlet connection:	DN 200
Pressure rating for connection:	PN 25
Flange size for motor:	FF500
Connect code:	F
Liquid:	
Pumped liquid:	Water
Liquid temperature range:	-20 .. 120 °C
Selected liquid temperature:	20 °C
Density:	998.2 kg/m ³
Electrical data:	
Motor standard:	IEC
Motor type:	SIEMENS
IE Efficiency class:	IE3
Rated power - P2:	75 kW
Power (P2) required by pump:	75 kW
Mains frequency:	50 Hz

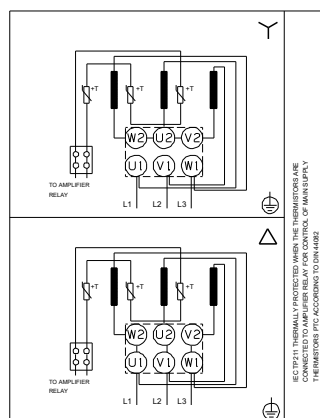
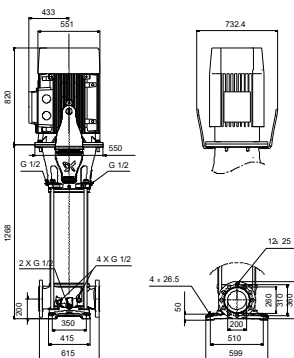
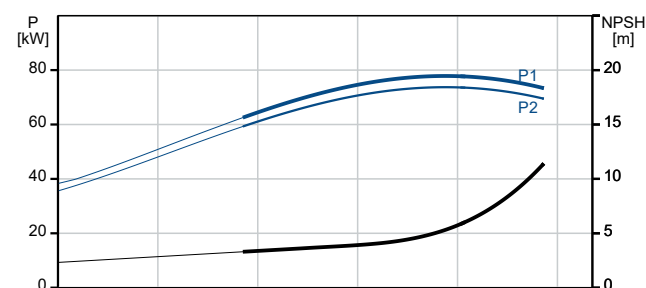
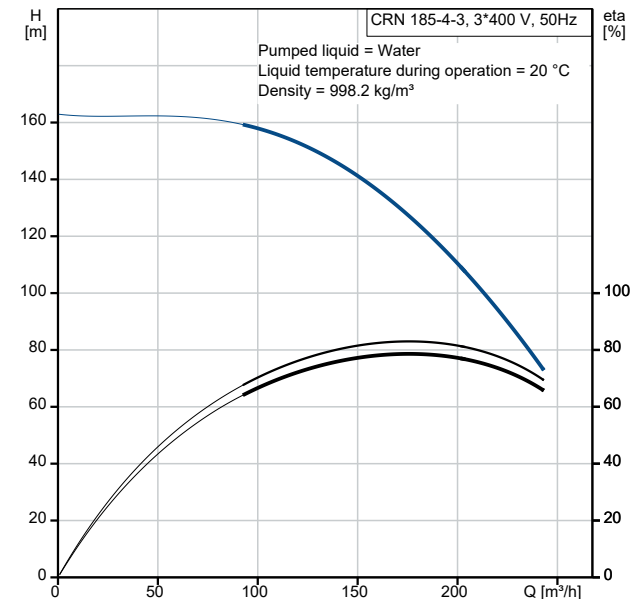



Company name:

Created by:

Phone:

Date:

30/11/2022

Description	Value
Rated voltage:	3 x 380-420D/660-725Y V
Rated current:	128/74 A
Starting current:	680-680 %
Cos phi - power factor:	0.89
Rated speed:	2975 rpm
Efficiency:	IE3 94,7%
Motor efficiency at full load:	94.7-94.7 %
Motor efficiency at 3/4 load:	94.8-94.8 %
Motor efficiency at 1/2 load:	94.1-94.1 %
Number of poles:	2
Enclosure class (IEC 34-5):	IP55
Insulation class (IEC 85):	F
Built-in motor protection:	PTC
Motor No:	83U15240
Controls:	
Frequency converter:	NONE
Others:	
Minimum efficiency index, MEI \geq :	0.70
Net weight:	855 kg
Gross weight:	1020 kg
Shipping volume:	2.48 m ³
Thrust handling device:	Y

99143741 CRN 185-4-3 A-F-A-E-HQQE 50 Hz

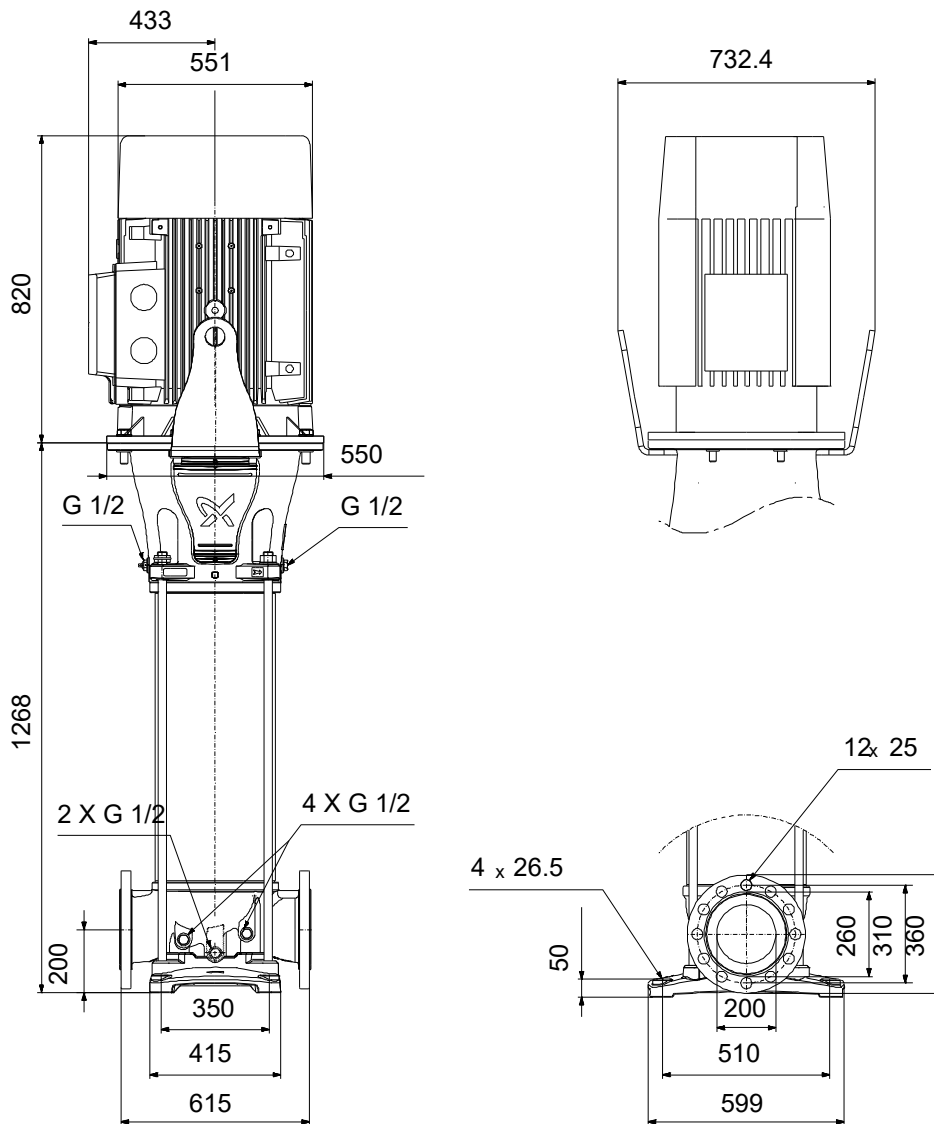

Note! All units are in [mm] unless others are stated.
Disclaimer: This simplified dimensional drawing does not show all details.

99143741 CRN 185-4-3 A-F-A-E-HQQE 50 Hz



IEC TP211 THERMALLY PROTECTED WHEN THE THERMISTORS ARE
CONNECTED TO AMPLIFIER RELAY FOR CONTROL OF MAIN SUPPLY
THERMISTORS PTC ACCORDING TO DIN 44082

Note! All units are in [mm] unless others are stated.

