

Qty.	Description
------	-------------

1	COMFORT 15-14 B PM GB
---	-----------------------



Note! Product picture may differ from actual product

Product No.: On request

The Grundfos Comfort B PM and BX PM pumps are designed for recirculation of domestic hot water in single-family and two-family houses securing hot water instantly to all faucets.

The pumps have a corrosion-resistant pump housing suitable for drinking water and are powered by a single-phase, high-efficiency ECM with permanent-magnet rotor.

COMFORT B PM and BX PM meet homeowner requirements for continuous operation.

COMFORT BX PM has a built-in isolating valve and a non-return valve (fitting). This ensures that maintenance can be carried out without draining the system. The non-return valve also prevents reversed flow during operation.

On request COMFORT 15-14 B PM GB

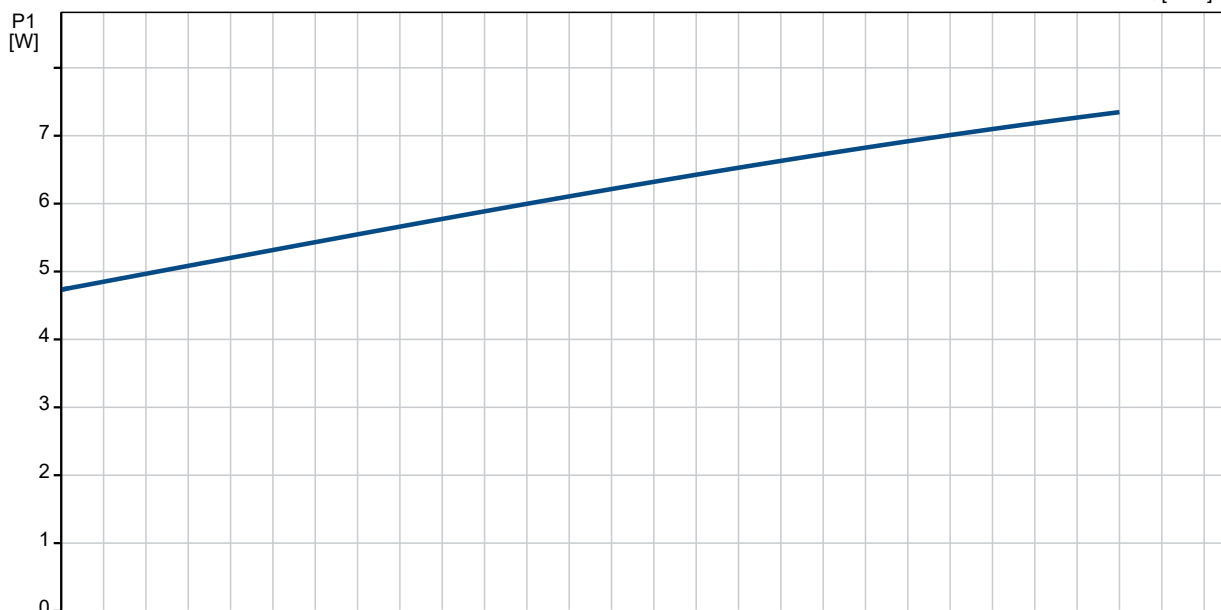
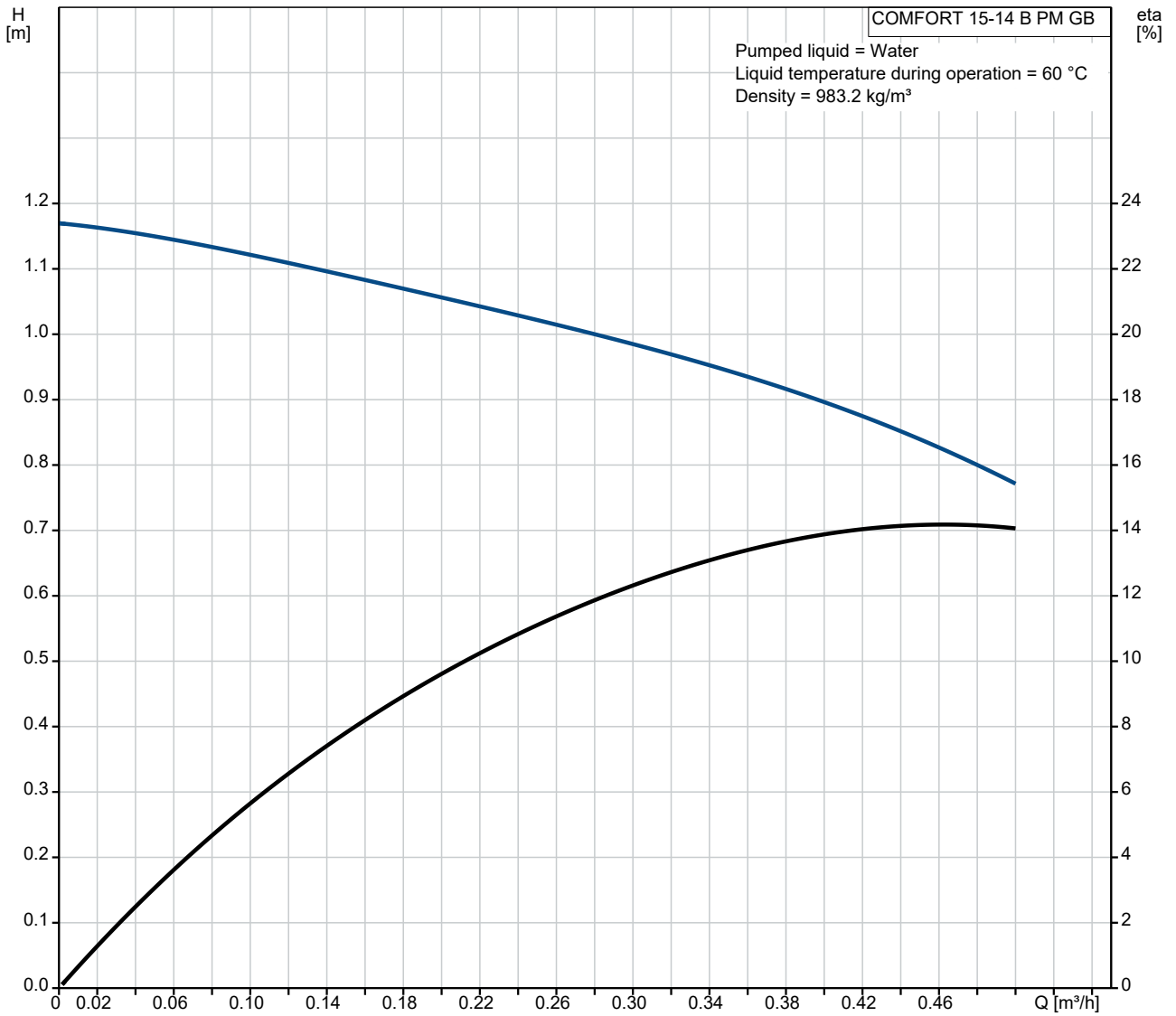

Description	Value
General information:	
Product name:	COMFORT 15-14 B PM GB
Product No:	On request
EAN number:	On request
Technical:	
Speed no:	1
Head max:	14 dm
TF class:	95
Approvals on nameplate:	CE,VDE,WEEE
Materials:	
Pump housing:	Brass
Impeller:	Composite
Installation:	
Maximum operating pressure:	10 bar
Type of connection:	Rp
Pipe connection:	1/2
Port-to-port length:	80 mm
Liquid:	
Pumped liquid:	Water
Liquid temperature range:	2 .. 95 °C
Selected liquid temperature:	60 °C
Density:	983.2 kg/m ³
Electrical data:	
Max. power input:	7 W
Mains frequency:	50 / 60 Hz
Rated voltage:	230 V
Current in speed 3:	0.07 A
Capacitor size - run:	0.6 µF
Enclosure class (IEC 34-5):	IP44
Insulation class (IEC 85):	F
Built-in motor protection:	ELECT.
Thermal protec:	Impedance protected
Others:	
Net weight:	0.86 kg
Gross weight:	0.96 kg
Shipping volume:	0.003 m ³
Country code:	GB
Country of origin:	DE
Custom tariff no.:	84137030

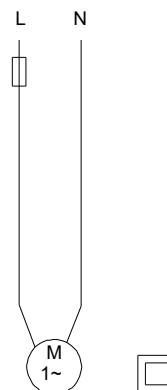
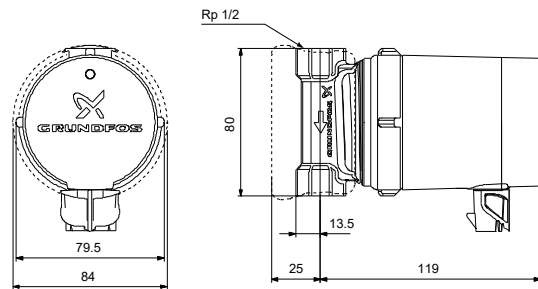
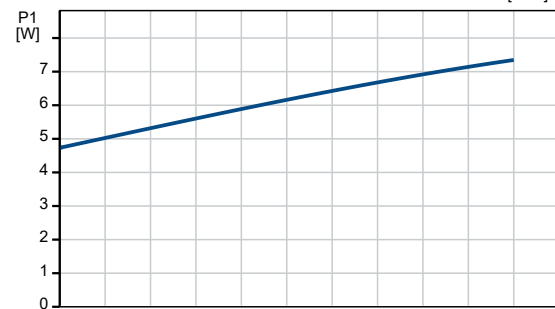
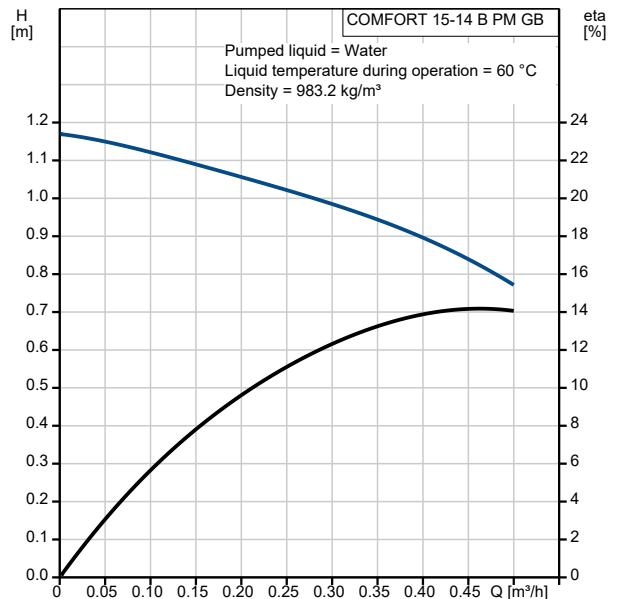

On request COMFORT 15-14 B PM GB

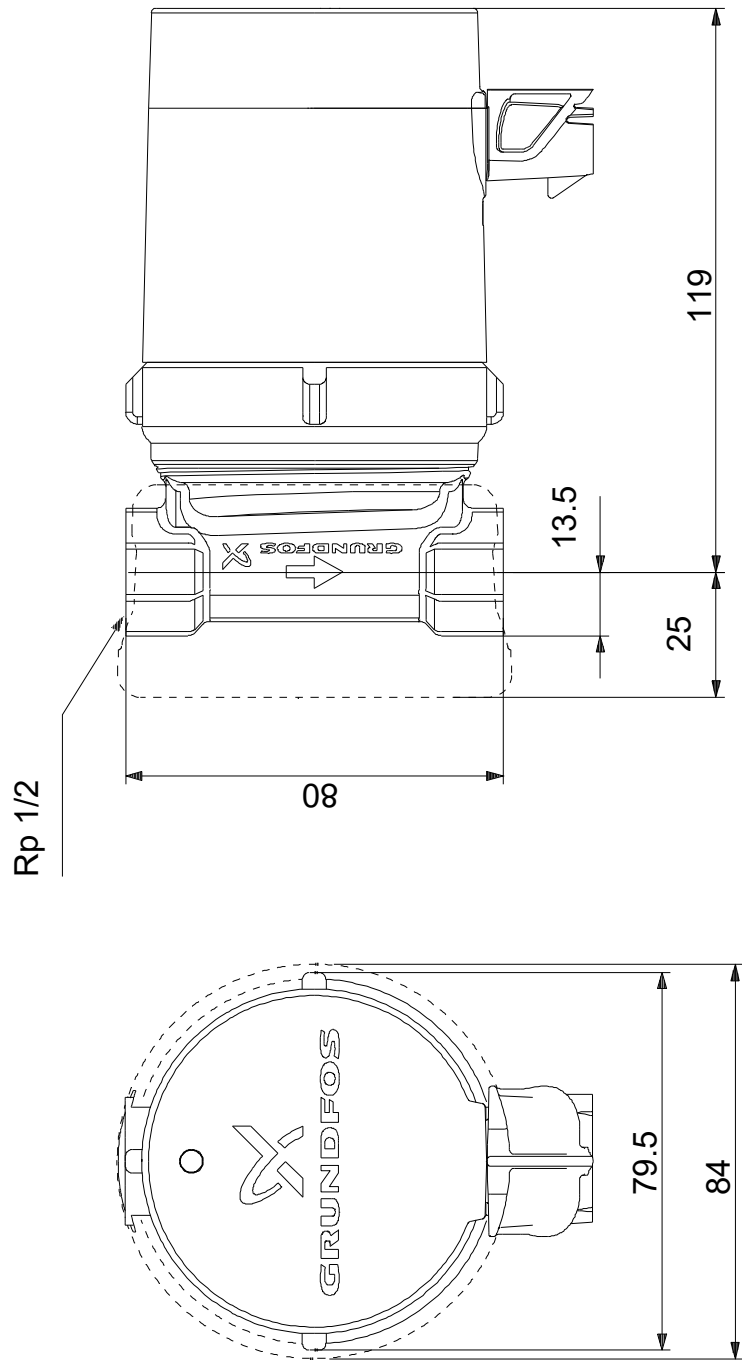

Note! All units are in [mm] unless others are stated.
Disclaimer: This simplified dimensional drawing does not show all details.

On request COMFORT 15-14 B PM GB



Note! All units are in [mm] unless others are stated.



Company name:

Created by:

Phone:

Date: 27/10/2021

Order Data:

Product name: COMFORT 15-14 B PM GB

Amount: 1

Product No: On request

Total: Price on request
