

Qty.	Description
------	-------------

1	MAGNA1 65-120 F N
---	-------------------



Note! Product picture may differ from actual product

Product No.: On request

The Grundfos MAGNA1 circulator pump is the simple option for a job well done.

With its high energy efficiency the product lives up to the EuP 2015 regulations ensuring substantial savings on electricity, and with its intuitive, user-friendly interface and maintenance-free design, MAGNA1 is the ideal circulator pump for basic performance needs in applications where basic system control and monitoring are desired.

With this range of circulator pumps, everything from setup to basic control and monitoring are made easy. The pump is maintenance-free due to the canned-rotor type design.

MAGNA1 offers the possibility of monitoring the pump via the fault relay output. The digital start/stop input remotely controls the pump.

The pump communicates wirelessly with the Grundfos GO Remote app.

MAGNA1 can work as main pump in both heating and cooling applications, including:

- Mixing loops
- Heating surfaces
- Air-conditioning surfaces
- Ground-source heat pump systems
- Smaller chiller applications.

MAGNA1 is a single-phase pump and characterised by having the controller and operating panel integrated in the control box.

The pump housing is available in both cast-iron and stainless-steel versions.

The composite rotor can is carbon-fibre reinforced, the bearing plate and rotor cladding are made of stainless steel and the stator housing is made of aluminium.

The power electronics are air-cooled.

The pump incorporates a 4-pole synchronous, permanent-magnet motor (PM motor). This motor type is characterised by higher efficiency than a conventional asynchronous squirrel-cage motor. The pump speed is controlled by an integrated frequency converter.

On request MAGNA1 65-120 F N

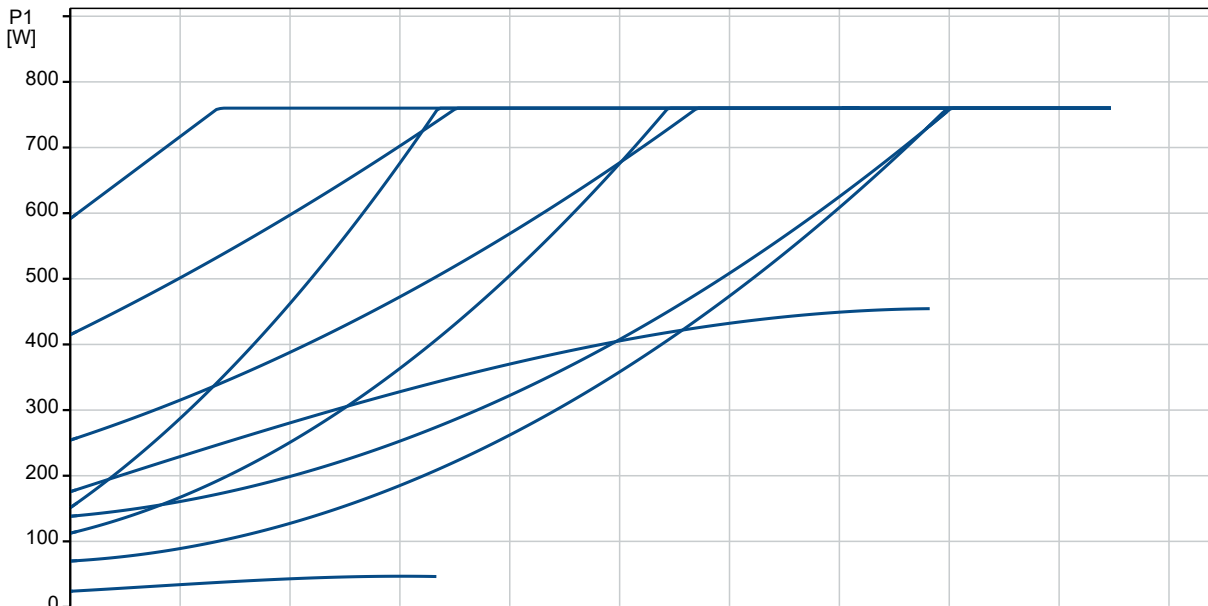
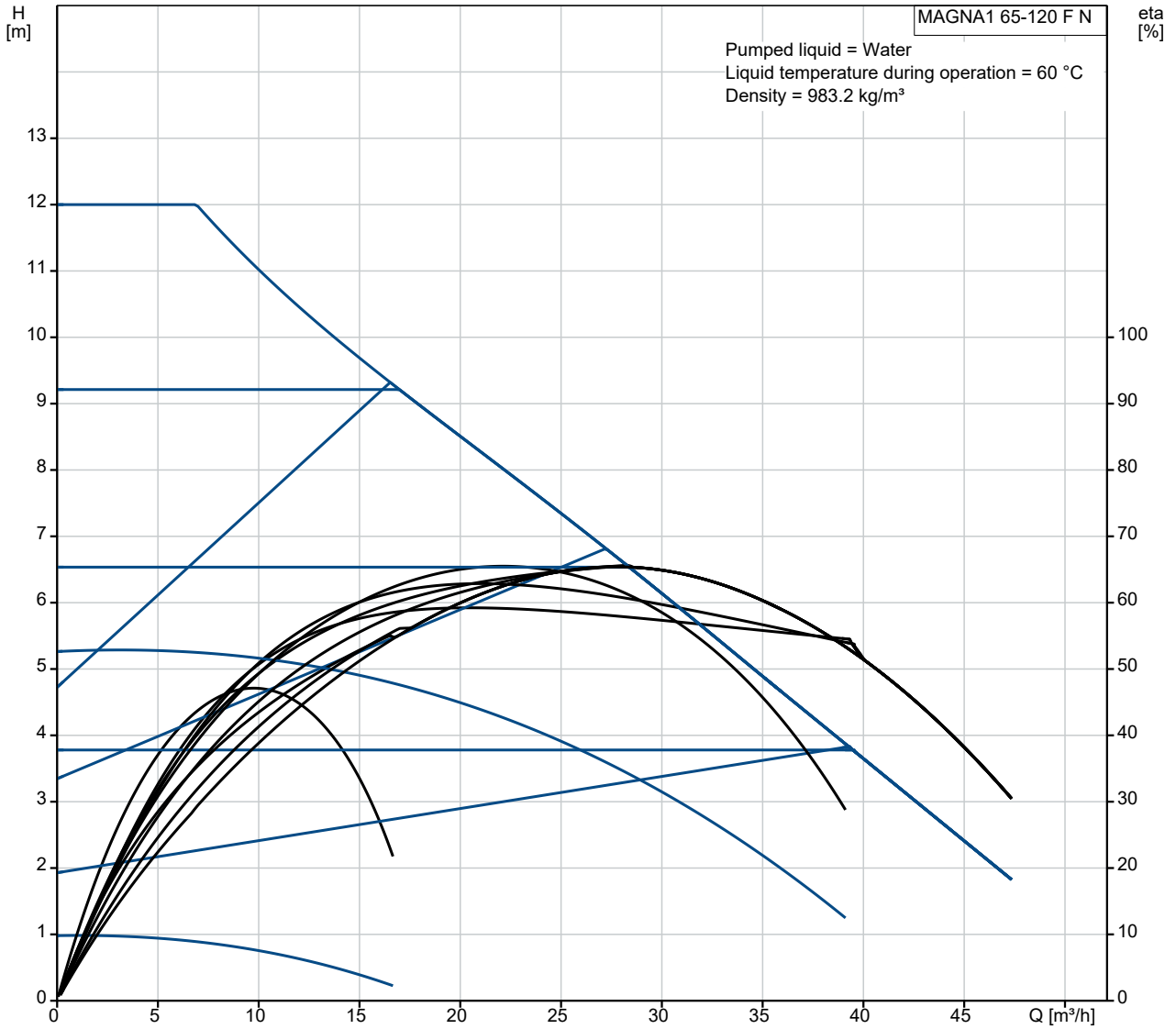

Description	Value
General information:	
Product name:	MAGNA1 65-120 F N
Product No:	On request
EAN number:	On request
Technical:	
Head max:	120 dm
TF class:	110
Approvals on nameplate:	CE,VDE,EAC,CN ROHS,WEEE
Model:	C
Materials:	
Pump housing:	Stainless steel
Pump housing:	EN 1.4308
Pump housing:	ASTM 351 CF8
Impeller:	PES 30%GF
Installation:	
Range of ambient temperature:	0 .. 40 °C
Maximum operating pressure:	10 bar
Flange standard:	DIN
Pipe connection:	DN 65
Pressure rating:	PN 6/10
Port-to-port length:	340 mm
Liquid:	
Pumped liquid:	Water
Liquid temperature range:	-10 .. 110 °C
Selected liquid temperature:	60 °C
Density:	983.2 kg/m ³
Electrical data:	
Power input - P1:	24.38 .. 774 W
Mains frequency:	50 / 60 Hz
Rated voltage:	1 x 230 V
Maximum current consumption:	0.26 .. 3.42 A
Enclosure class (IEC 34-5):	X4D
Insulation class (IEC 85):	F
Others:	
Energy (EEI):	0.18
Net weight:	22.3 kg
Gross weight:	24.6 kg
Shipping volume:	0.057 m ³

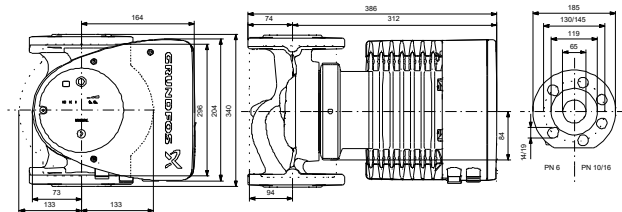
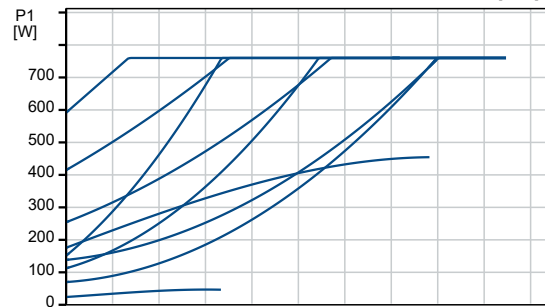
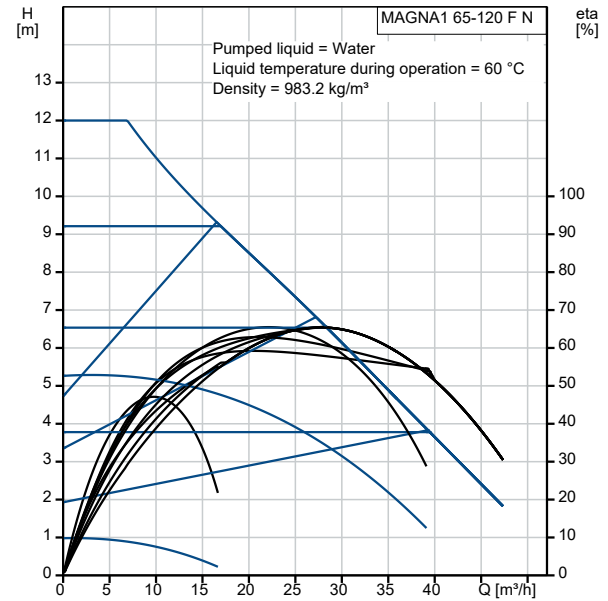

Example of mains-connected motor with mains switch, backup fuse and additional protection

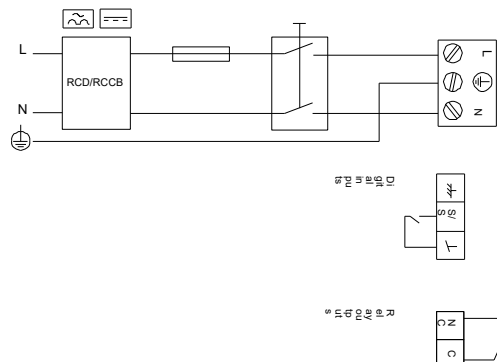

On request MAGNA1 65-120 F N

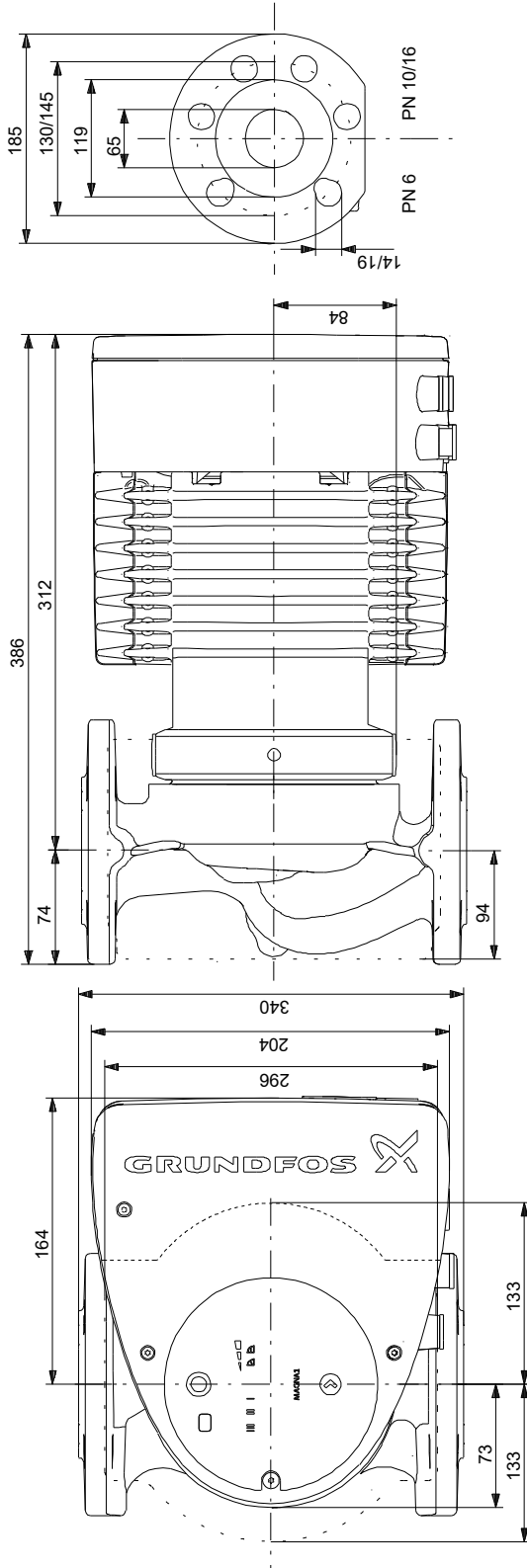

Note! All units are in [mm] unless others are stated.

Disclaimer: This simplified dimensional drawing does not show all details.

On request MAGNA1 65-120 F N

Example of mains-connected motor with mains switch, backup fuse and additional protection

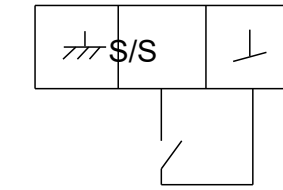

Digital inputs

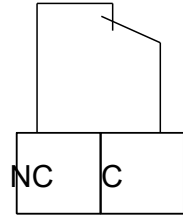

Relay outputs

Note! All units are in [mm] unless others are stated.