

Qty.	Description
1	<p data-bbox="193 159 606 190">TPE3 D 32-120 S-A-F-A-BQQE-CDB</p>  <p data-bbox="592 506 1062 533">Note! Product picture may differ from actual product</p> <p data-bbox="193 539 478 566">Product No.: On request</p> <p data-bbox="193 600 1458 651">Single-stage, close-coupled, volute twin-head pump with in-line suction and discharge ports of identical diameter. The twin-head pump is designed with two parallel power-heads.</p> <p data-bbox="193 658 1401 710">The pump is of the top-pull-out design, i.e. the power head (motor, pump head and impeller) can be removed for maintenance or service while the pump housing remains in the pipework.</p> <p data-bbox="193 716 909 743">Each power head is fitted with an unbalanced rubber bellows seal.</p> <p data-bbox="193 750 1382 801">The shaft seal is according to EN 12756. Pipework connection is via PN 6/10 DIN flanges (EN 1092-2 and ISO 7005-2).</p> <p data-bbox="193 808 1390 860">Each power head is fitted with a fan-cooled, permanent-magnet synchronous motor of identical size. The motor efficiency is classified as IE5 in accordance with IEC 60034-30-2.</p> <p data-bbox="193 866 1398 916">The motor includes a frequency converter and PI controller in the motor terminal box. This enables continuously variable control of the motor speed, which again enables adaptation of the performance to a given requirement.</p> <p data-bbox="193 922 1070 949">The pump is fitted with a combined temperature- and differential pressure sensor.</p> <p data-bbox="193 981 300 1008">Controls:</p> <p data-bbox="193 1014 641 1041">Frequency converter: Built-in</p> <p data-bbox="193 1072 276 1099">Liquid:</p> <p data-bbox="193 1106 633 1133">Pumped liquid: Water</p> <p data-bbox="193 1140 702 1167">Liquid temperature range: -25 .. 120 °C</p> <p data-bbox="193 1173 628 1200">Selected liquid temperature: 20 °C</p> <p data-bbox="193 1207 695 1234">Density: 998.2 kg/m³</p> <p data-bbox="193 1265 316 1292">Technical:</p> <p data-bbox="193 1299 820 1326">Pump speed on which pump data are based: 3600 rpm</p> <p data-bbox="193 1332 655 1359">Rated flow: 9.5 m³/h</p> <p data-bbox="193 1366 628 1393">Rated head: 6.1 m</p> <p data-bbox="193 1400 641 1426">Actual impeller diameter: 62 mm</p> <p data-bbox="193 1433 638 1460">Code for shaft seal: BQQE</p> <p data-bbox="193 1467 772 1494">Curve tolerance: ISO9906:2012 3B2</p> <p data-bbox="193 1525 309 1552">Materials:</p> <p data-bbox="193 1559 730 1610">Pump housing: Cast iron EN-GJL-250 ASTM class 35</p> <p data-bbox="193 1617 718 1668">Impeller: Composite PES+30% GF</p> <p data-bbox="193 1700 327 1727">Installation:</p> <p data-bbox="193 1733 691 1760">Range of ambient temperature: -20 .. 50 °C</p> <p data-bbox="193 1767 636 1794">Maximum operating pressure: 10 bar</p> <p data-bbox="193 1800 730 1827">Max pressure at stated temp: 10 bar / 120 °C</p> <p data-bbox="193 1834 608 1861">Type of connection: DIN</p> <p data-bbox="193 1868 636 1895">Size of connection: DN 32</p> <p data-bbox="193 1901 655 1928">Pressure rating for connection: PN 6/10</p> <p data-bbox="193 1935 655 1962">Port-to-port length: 220 mm</p> <p data-bbox="193 1968 611 1995">Flange size for motor: 56C</p> <p data-bbox="193 2027 363 2054">Electrical data:</p> <p data-bbox="193 2060 611 2087">Motor type: 71A</p> <p data-bbox="193 2094 604 2121">IE Efficiency class: IE5</p> <p data-bbox="193 2128 655 2154">Rated power - P2: 0.25 kW</p>

Qty.	Description																																		
1	<table> <tr> <td>Mains frequency:</td> <td>50 Hz</td> </tr> <tr> <td>Rated voltage:</td> <td>3 x 380-500 V</td> </tr> <tr> <td>Rated current:</td> <td>0.90-0.75 A</td> </tr> <tr> <td>Cos phi - power factor:</td> <td>0.58-0.50</td> </tr> <tr> <td>Rated speed:</td> <td>360-4000 rpm</td> </tr> <tr> <td>Efficiency:</td> <td>81.2%</td> </tr> <tr> <td>Motor efficiency at full load:</td> <td>81.2 %</td> </tr> <tr> <td>Enclosure class (IEC 34-5):</td> <td>IP55</td> </tr> <tr> <td>Insulation class (IEC 85):</td> <td>F</td> </tr> <tr> <td>Motor No:</td> <td>99137997</td> </tr> <tr> <td colspan="2">Others:</td> </tr> <tr> <td>Minimum efficiency index, MEI ≥:</td> <td>0.70</td> </tr> <tr> <td>Net weight:</td> <td>46.8 kg</td> </tr> <tr> <td>Gross weight:</td> <td>60.1 kg</td> </tr> <tr> <td>Shipping volume:</td> <td>0.252 m³</td> </tr> <tr> <td>Country of origin:</td> <td>HU</td> </tr> <tr> <td>Custom tariff no.:</td> <td>84137065</td> </tr> </table>	Mains frequency:	50 Hz	Rated voltage:	3 x 380-500 V	Rated current:	0.90-0.75 A	Cos phi - power factor:	0.58-0.50	Rated speed:	360-4000 rpm	Efficiency:	81.2%	Motor efficiency at full load:	81.2 %	Enclosure class (IEC 34-5):	IP55	Insulation class (IEC 85):	F	Motor No:	99137997	Others:		Minimum efficiency index, MEI ≥:	0.70	Net weight:	46.8 kg	Gross weight:	60.1 kg	Shipping volume:	0.252 m ³	Country of origin:	HU	Custom tariff no.:	84137065
Mains frequency:	50 Hz																																		
Rated voltage:	3 x 380-500 V																																		
Rated current:	0.90-0.75 A																																		
Cos phi - power factor:	0.58-0.50																																		
Rated speed:	360-4000 rpm																																		
Efficiency:	81.2%																																		
Motor efficiency at full load:	81.2 %																																		
Enclosure class (IEC 34-5):	IP55																																		
Insulation class (IEC 85):	F																																		
Motor No:	99137997																																		
Others:																																			
Minimum efficiency index, MEI ≥:	0.70																																		
Net weight:	46.8 kg																																		
Gross weight:	60.1 kg																																		
Shipping volume:	0.252 m ³																																		
Country of origin:	HU																																		
Custom tariff no.:	84137065																																		

Description	Value
General information:	
Product name:	TPE3 D 32-120 S-A-F-A-BQQE-CDB
Product No:	On request
EAN number:	On request
Technical:	
Pump speed on which pump data are based:	3600 rpm
Rated flow:	9.5 m³/h
Rated head:	6.1 m
Maximum head:	120 dm
Actual impeller diameter:	62 mm
Code for shaft seal:	BQQE
Curve tolerance:	ISO9906:2012 3B2
Pump version:	A
Materials:	
Pump housing:	Cast iron
Pump housing:	EN-GJL-250
Pump housing:	ASTM class 35
Impeller:	Composite
Impeller:	PES+30% GF
Material code:	A
Installation:	
Range of ambient temperature:	-20 .. 50 °C
Maximum operating pressure:	10 bar
Max pressure at stated temp:	10 bar / 120 °C
Type of connection:	DIN
Size of connection:	DN 32
Pressure rating for connection:	PN 6/10
Port-to-port length:	220 mm
Flange size for motor:	56C
Connect code:	F
Liquid:	
Pumped liquid:	Water
Liquid temperature range:	-25 .. 120 °C
Selected liquid temperature:	20 °C
Density:	998.2 kg/m³
Electrical data:	
Motor type:	71A
IE Efficiency class:	IE5
Rated power - P2:	0.25 kW
Mains frequency:	50 Hz
Rated voltage:	3 x 380-500 V
Rated current:	0.90-0.75 A
Cos phi - power factor:	0.58-0.50
Rated speed:	360-4000 rpm
Efficiency:	81.2%
Motor efficiency at full load:	81.2 %
Enclosure class (IEC 34-5):	IP55
Insulation class (IEC 85):	F
Built-in motor protection:	ELEC
Motor No:	99137997
Controls:	
Control panel:	HMI300 - Graphical
Function Module:	FM300 - Advanced
Frequency converter:	Built-in
Others:	
Minimum efficiency index, MEI ≥:	0.70
Net weight:	46.8 kg
Gross weight:	60.1 kg
Shipping volume:	0.252 m³
Config. file no:	98484634
Country of origin:	HU
Custom tariff no.:	84137065

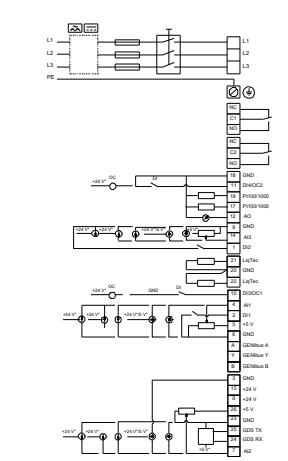
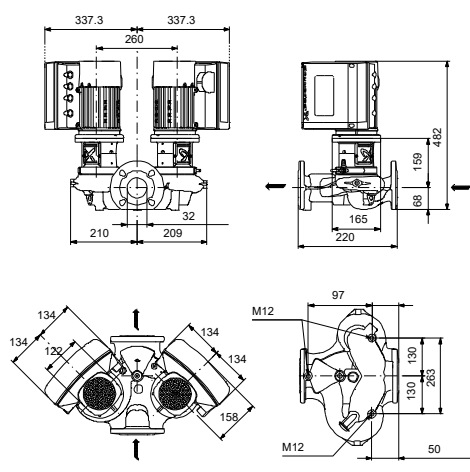
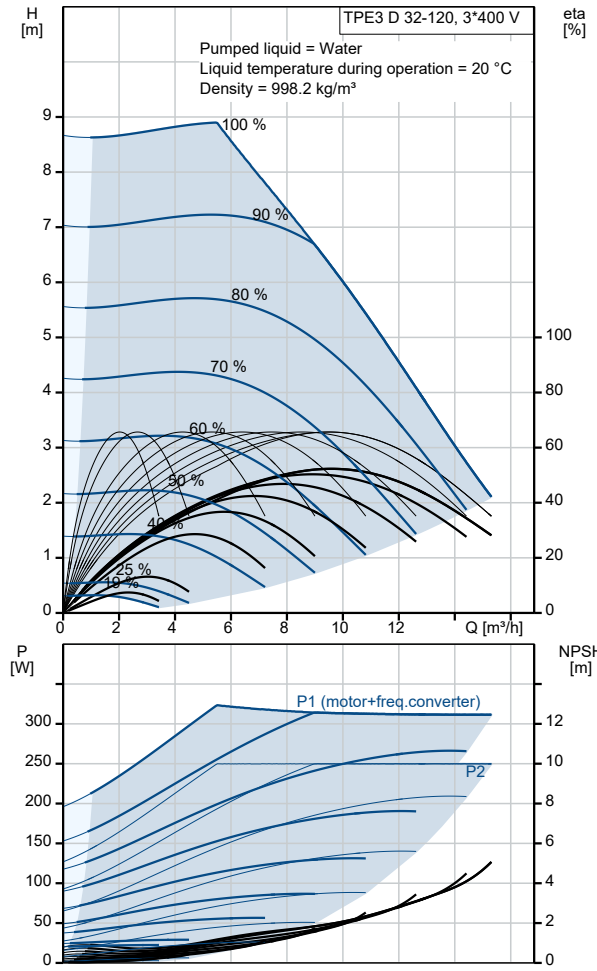

On request TPE3 D 32-120 S-A-F-A-BQQE-CDB 50 Hz

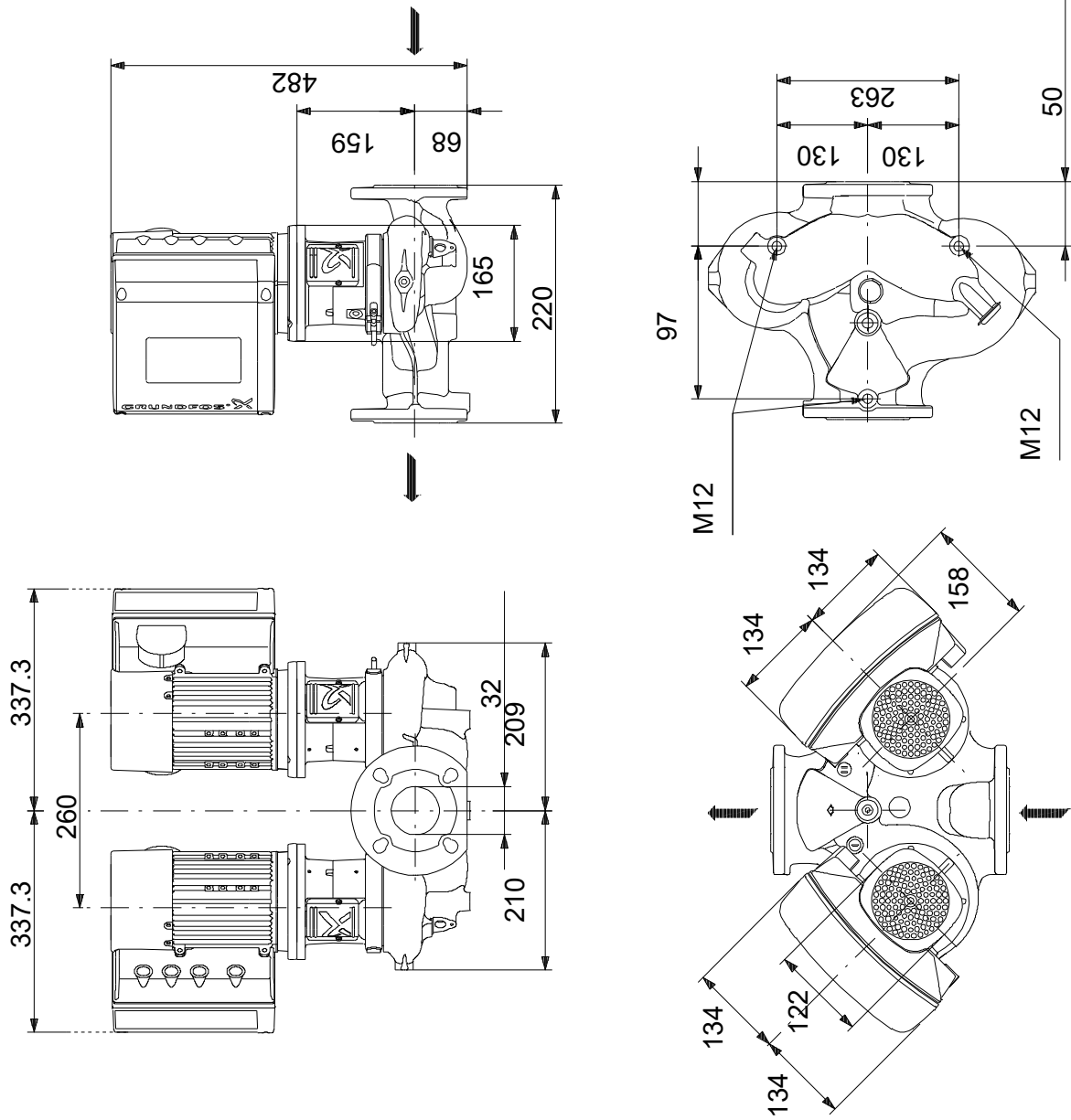

Note! All units are in [mm] unless others are stated.
 Disclaimer: This simplified dimensional drawing does not show all details.

