

Qty.	Description
1	<p><b>CUE 1X200-240V IP21 1,5KW</b></p>  <p><b>Note! Product picture may differ from actual product</b></p> <p>Product No.: <a href="#">99616602</a></p> <p>CUE is a complete range of external frequency converters designed for speed control of a wide range of Grundfos pumps. CUE has a built-in PI controller and offers the same functionality and user-interface as Grundfos E-pumps. CUE solutions can thus be seen as an extension to the E-pump range.</p> <p>By choosing a CUE-solution, you will get the following benefits:</p> <ul style="list-style-type: none"><li>- Grundfos E-pump functionality and user-interface</li><li>- application- and pump-family-related functions</li><li>- increased comfort compared to fixed-speed pumps</li><li>- very easy installation and commissioning compared to standard frequency converters</li><li>- speed control of pumps up to 250 kW</li><li>- speed control of pumps installed in potentially explosive environments.</li></ul> <p>CUE offers the following inputs and output:</p> <ul style="list-style-type: none"><li>- RS-485 GENIbus</li><li>- an analog 0-10 V input for external setpoint</li><li>- an analog 0/4-20 mA input for sensor</li><li>- four digital inputs for various functions, for instance external start/stop</li><li>- two signal relays (C/NO/NC).</li></ul> <p>Accessories:</p> <p>Input/output add-on board</p> <p>Provides additional input:</p> <ul style="list-style-type: none"><li>- one 0/4-20 mA analog input for an additional sensor</li><li>- one 0-20 mA analog output</li><li>- two inputs for Pt100/Pt1000 temperature sensors, for instance for bearing monitoring.</li></ul> <p>Motor filters:</p> <p>For reduction of dU/dt and peak voltages to the motor windings and for reduction of the acoustic noise generated in the motor, a number of motor filters are offered:</p> <ul style="list-style-type: none"><li>- dU/dt filters , 11-250 kW</li><li>- Sine wave filters, 0.55-250 kW.</li></ul> <p>Technical:</p> <p>Approvals on nameplate: CE, CULUS, C-TICK</p> <p>Installation:</p> <p>Range of ambient temperature: 0 .. 45 °C Relative humidity: 5-95 %</p> <p>Electrical data:</p> <p>Rated power - P2: 1.5 kW Mains frequency: 50 / 60 Hz Rated voltage [V]: 1 x 200-240 V Rated current: 7.5 A Maximum current consumption: 7.5 A Efficiency at full load: 96 % Enclosure class (IEC 34-5): IP21</p>



Company name: Pump Sales Direct

Created by:

Phone:

Date: 20/06/2022

Qty.	Description
------	-------------

	Others: Net weight: 23 kg Danish VVS No.: 382994215
--	---

Description	Value
<b>General information:</b>	
Product name:	CUE 1X200-240V IP21 1,5KW
Product No:	99616602
EAN number:	5713831973072
<b>Technical:</b>	
Approvals on nameplate:	CE, CULUS, C-TICK
<b>Installation:</b>	
Range of ambient temperature:	0 .. 45 °C
Relative humidity:	5-95 %
Mounted on:	Wall
<b>Electrical data:</b>	
Rated power - P2:	1.5 kW
Mains frequency:	50 / 60 Hz
Rated voltage [V]:	1 x 200-240 V
Rated current:	7.5 A
Maximum current consumption:	7.5 A
Efficiency at full load:	96 %
Enclosure class (IEC 34-5):	IP21
Built-in motor protection:	YES
Thermal protec:	external
Cable length:	150/300 m
<b>Others:</b>	
Net weight:	23 kg
Danish VVS No.:	382994215

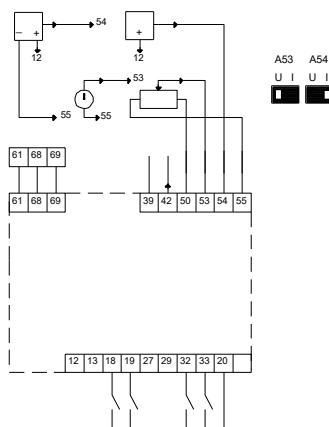
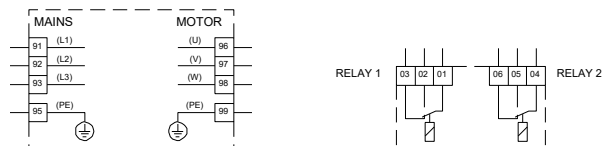
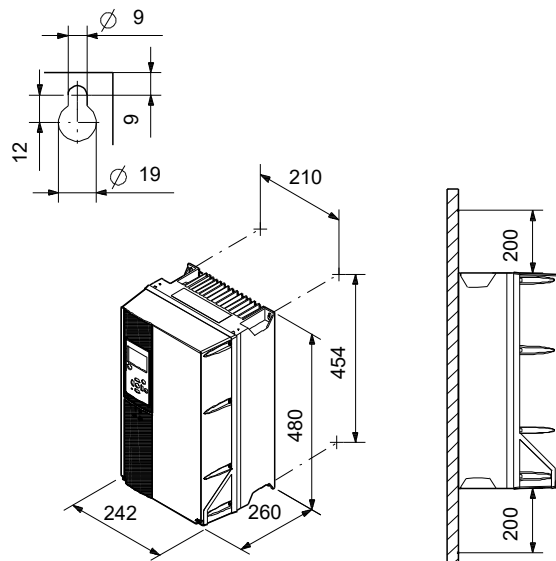

## 99616602 CUE 1X200-240V IP21 1,5KW

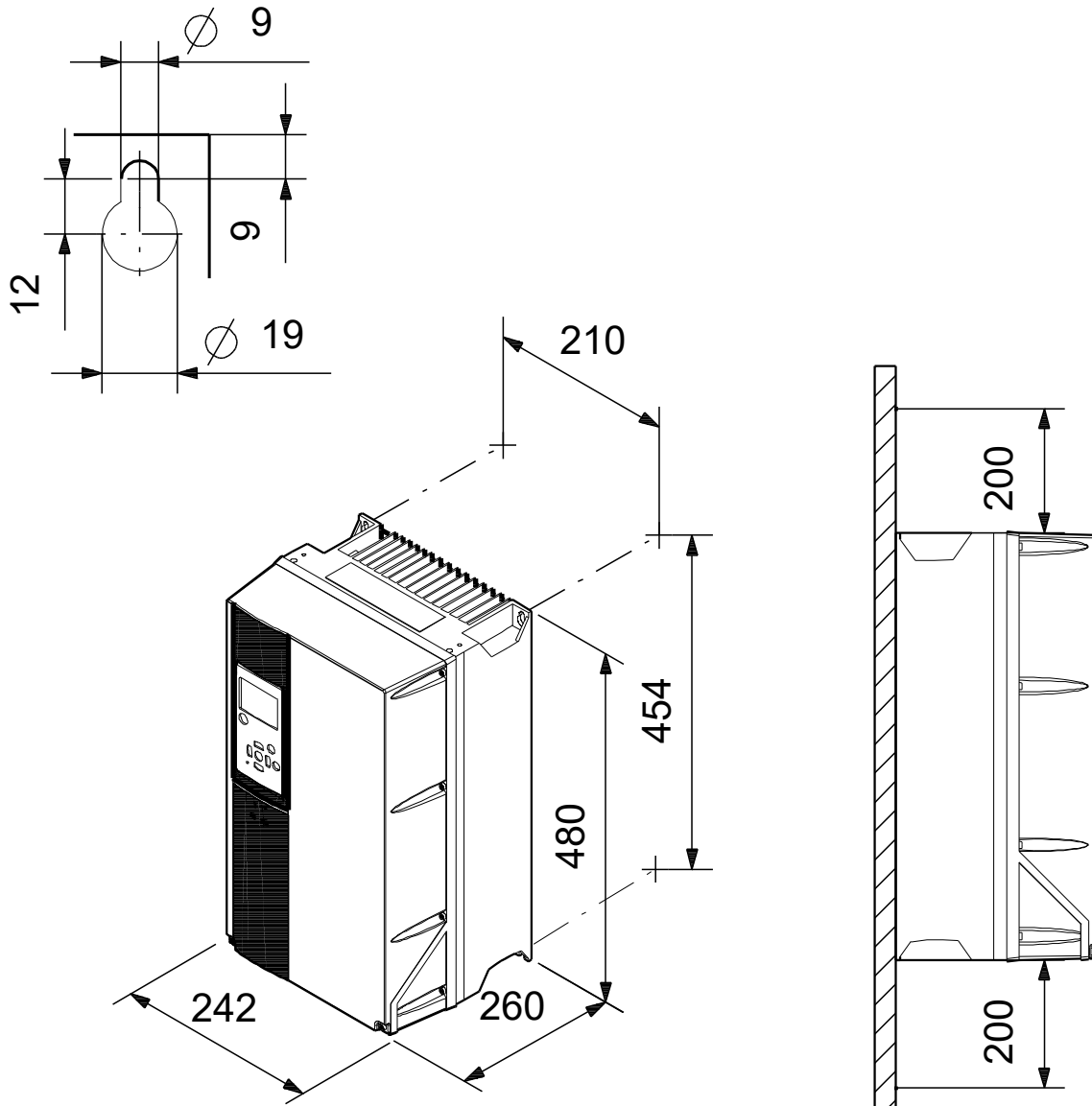

Note! All units are in [mm] unless others are stated.  
Disclaimer: This simplified dimensional drawing does not show all details.

## 99616602 CUE 1X200-240V IP21 1,5KW

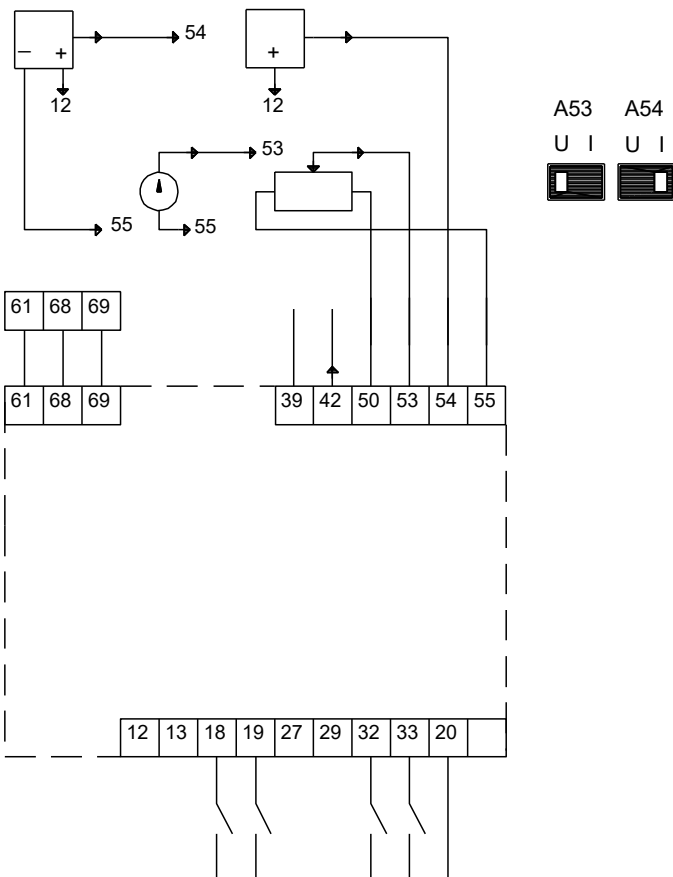
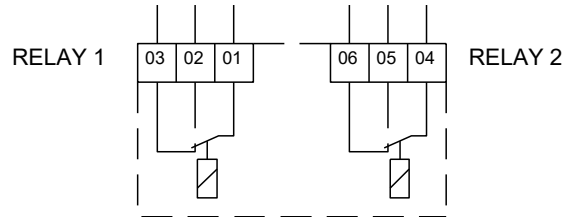
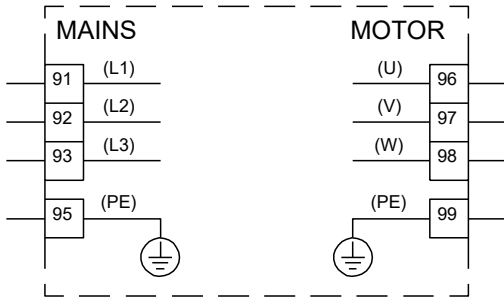

Note! All units are in [mm] unless others are stated.



**Company name:** Pump Sales Direct

**Created by:**

**Phone:**

**Date:** 20/06/2022

---

**Order Data:**

Product name: CUE 1X200-240V IP21 1,5KW

Amount: 1

Product No: 99616602

Total: Price on request

---