

Qty.	Description
1	<p data-bbox="201 338 533 365"><b>CUE 1X200-240V IP55 7,5KW</b></p> <div data-bbox="320 416 459 674" style="text-align: center;">  </div> <p data-bbox="592 685 1062 707" style="text-align: center;"><b>Note! Product picture may differ from actual product</b></p> <p data-bbox="201 719 464 741">Product No.: <a href="#">99616624</a></p> <p data-bbox="201 775 1422 853">CUE is a complete range of external frequency converters designed for speed control of a wide range of Grundfos pumps. CUE has a built-in PI controller and offers the same functionality and user-interface as Grundfos E-pumps. CUE solutions can thus be seen as an extension to the E-pump range.</p> <p data-bbox="201 864 874 887">By choosing a CUE-solution, you will get the following benefits:</p> <ul data-bbox="240 898 1190 1066" style="list-style-type: none"> <li>- Grundfos E-pump functionality and user-interface</li> <li>- application- and pump-family-related functions</li> <li>- increased comfort compared to fixed-speed pumps</li> <li>- very easy installation and commissioning compared to standard frequency converters</li> <li>- speed control of pumps up to 250 kW</li> <li>- speed control of pumps installed in potentially explosive environments.</li> </ul> <p data-bbox="201 1077 663 1099">CUE offers the following inputs and output:</p> <ul data-bbox="240 1111 1023 1245" style="list-style-type: none"> <li>- RS-485 GENIbus</li> <li>- an analog 0-10 V input for external setpoint</li> <li>- an analog 0/4-20 mA input for sensor</li> <li>- four digital inputs for various functions, for instance external start/stop</li> <li>- two signal relays (C/NO/NC).</li> </ul> <p data-bbox="201 1279 336 1301">Accessories:</p> <p data-bbox="201 1312 480 1335">Input/output add-on board</p> <p data-bbox="201 1346 472 1368">Provides additional input:</p> <ul data-bbox="240 1379 1190 1458" style="list-style-type: none"> <li>- one 0/4-20 mA analog input for an additional sensor</li> <li>- one 0-20 mA analog output</li> <li>- two inputs for Pt100/Pt1000 temperature sensors, for instance for bearing monitoring.</li> </ul> <p data-bbox="201 1491 336 1514">Motor filters:</p> <p data-bbox="201 1525 1430 1570">For reduction of dU/dt and peak voltages to the motor windings and for reduction of the acoustic noise generated in the motor, a number of motor filters are offered:</p> <ul data-bbox="240 1581 616 1637" style="list-style-type: none"> <li>- dU/dt filters , 11-250 kW</li> <li>- Sine wave filters, 0.55-250 kW.</li> </ul> <p data-bbox="201 1671 312 1693">Technical:</p> <p data-bbox="201 1704 791 1727">Approvals on nameplate: CE, CULUS, C-TICK</p> <p data-bbox="201 1760 320 1783">Installation:</p> <p data-bbox="201 1794 663 1816">Range of ambient temperature: 0 .. 45 °C</p> <p data-bbox="201 1827 639 1850">Relative humidity: 5-95 %</p> <p data-bbox="201 1883 360 1906">Electrical data:</p> <p data-bbox="201 1917 639 1939">Rated power - P2: 7.5 kW</p> <p data-bbox="201 1951 679 1973">Mains frequency: 50 / 60 Hz</p> <p data-bbox="201 1984 711 2007">Rated voltage [V]: 1 x 200-240 V</p> <p data-bbox="201 2018 632 2040">Rated current: 30.8 A</p> <p data-bbox="201 2051 632 2074">Maximum current consumption: 30.8 A</p> <p data-bbox="201 2085 632 2107">Efficiency at full load: 98 %</p> <p data-bbox="201 2119 616 2141">Enclosure class (IEC 34-5): IP55</p>



Company name: Pump Sales Direct

Created by:

Phone:

Date: 20/06/2022

Qty.	Description
------	-------------

	Others: Net weight: 27 kg Danish VVS No.: 382994575
--	---

Description	Value
<b>General information:</b>	
Product name:	CUE 1X200-240V IP55 7,5KW
Product No:	99616624
EAN number:	5713831973294
<b>Technical:</b>	
Approvals on nameplate:	CE, CULUS, C-TICK
<b>Installation:</b>	
Range of ambient temperature:	0 .. 45 °C
Relative humidity:	5-95 %
Mounted on:	Wall
<b>Electrical data:</b>	
Rated power - P2:	7.5 kW
Mains frequency:	50 / 60 Hz
Rated voltage [V]:	1 x 200-240 V
Rated current:	30.8 A
Maximum current consumption:	30.8 A
Efficiency at full load:	98 %
Enclosure class (IEC 34-5):	IP55
Built-in motor protection:	YES
Thermal protec:	external
Cable length:	150/300 m
<b>Others:</b>	
Net weight:	27 kg
Danish VVS No.:	382994575

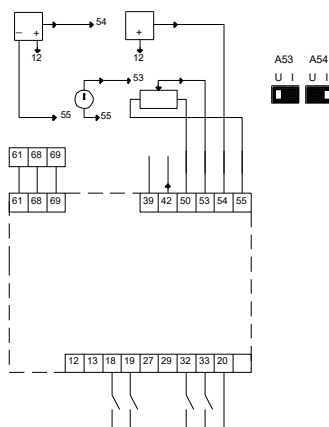
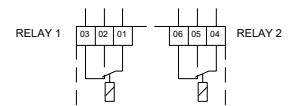
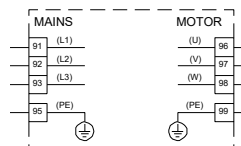
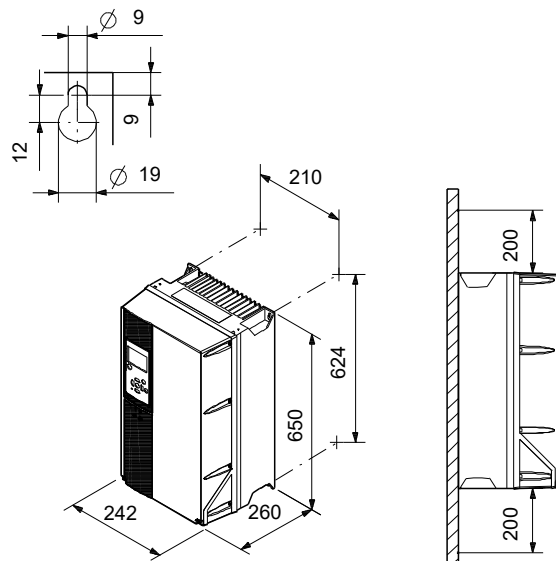

## 99616624 CUE 1X200-240V IP55 7,5KW

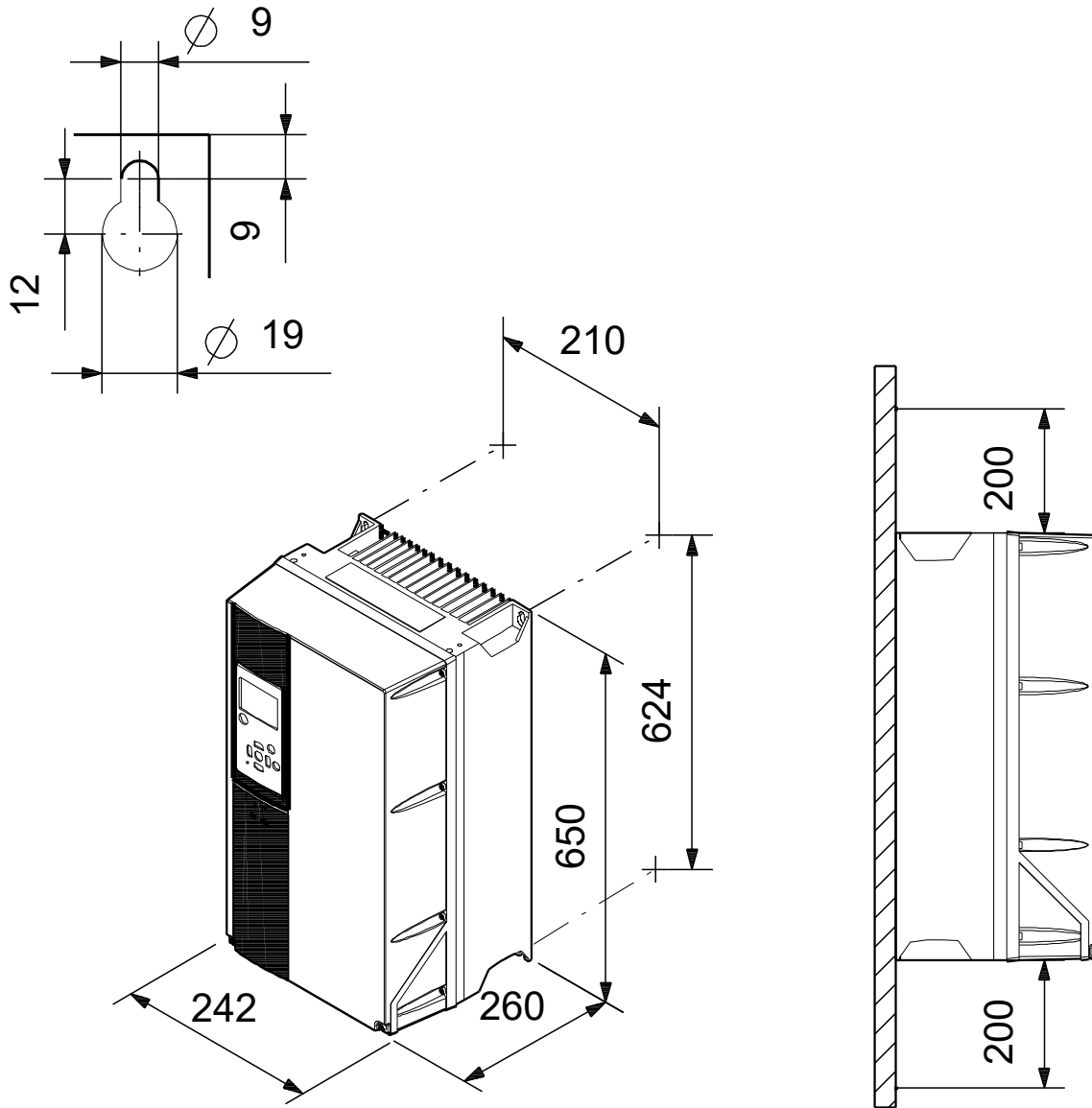

Note! All units are in [mm] unless others are stated.  
Disclaimer: This simplified dimensional drawing does not show all details.

## 99616624 CUE 1X200-240V IP55 7,5KW

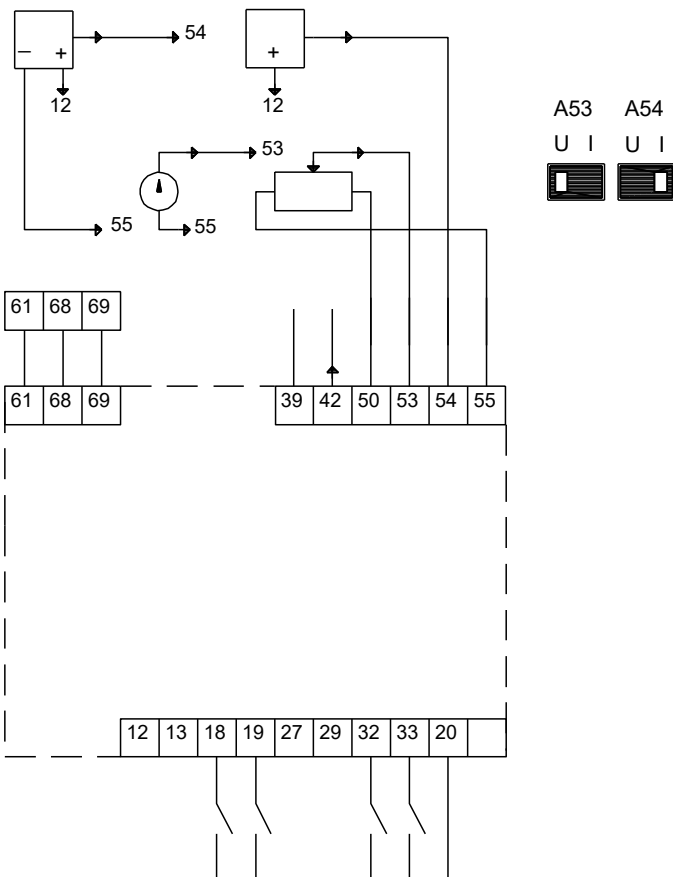
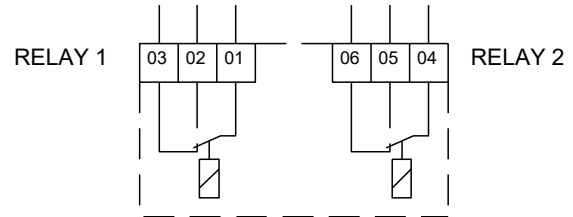
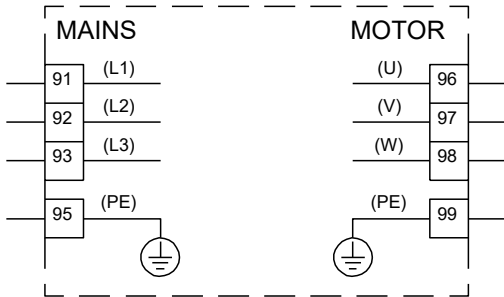

Note! All units are in [mm] unless others are stated.



**Company name:** Pump Sales Direct

**Created by:**

**Phone:**

**Date:** 20/06/2022

---

**Order Data:**

Product name: CUE 1X200-240V IP55 7,5KW

Amount: 1

Product No: 99616624

Total: Price on request

---