

Qty.	Description
------	-------------

1	LC 241
---	--------



Note! Product picture may differ from actual product

Product No.: [99877202](#)

The LC 241 level controllers offer a comprehensive range of features for control and monitoring of pumps in waste water and drainage systems or tank filling in water supply. The LC241 is a metal or plastic cabinet solution offering modularity and customization according to your needs.

The LC 241 pump controllers are designed for level control, monitoring and protection of Grundfos pumping systems one pumps

or two pumps starting direct-on-line, star delta or as soft starter.

The LC 241 pump controllers can be used in various type of empty application e.g. waste water transport, drainage or tank filling in water supply.

The set-up of the control is easily done either by the predefined application settings or via the step-by-step start-up wizard in the intuitive Grundfos GO app, using Bluetooth Smart technology.

With the Grundfos GO app, all detailed pump settings can be easily being configured, monitored and commissioned.

The controller is equipped with configurable input/output terminals, giving full flexibility for all applications.

However, as option the IO 241 module with more input/output options can be build-in.

Additional options like manual ON/OFF/AUTO switch, current transformer, Ex barrier for digital and analog sensor input,

fault light, can also be part of your customized solution.

Daily control, supervision and commissioning is straightforward with the intuitive and easy- to-use user interface.

This saves you valuable time when getting started, and in your daily interaction with pumps and the controller.

The controller integrates seamlessly into the Grundfos range of communication modules, ensuring an easy fit into any supervisory system such as SCADA or Grundfos CLOUD.

The controller maintains a detailed alarm and warning log with the last 20 alerts.

The alarm log can be accessed remotely via SCADA or Grundfos CLOUD.

You can also use Grundfos GO to inspect the logs in localized, translated text for easy troubleshooting and remedial measures at the pumping station.

The LC 241 controller enable:

- Control of 1 or 2 pumps based on signals from sensor input (analog, 0-5 V, 0.5-3.5V, 0-10 V, 0-20 mA, 4-20 mA or digital, float switch)
- Support up to five control levels for both analogue level transmitter or float switch operation
- Supports simple application where only one float switch is present - single float switch operation
- Configurable input/output terminals that can be used as digital input/output, analogue input and Pt 100/1000 inputs for flexible use in the actual application.
- Prevent the pumps with anti-seizing from choking or seizing due to limestone build-up or other deposits
- Prevent the mains load when several pumping stations are started up at the same time with power-on delay.
- Protection against water hammer as quick restart/simultaneous start is blocked and delayed
- Selection of automatic alarm resetting
- Setting of stop delays matching the actual operating conditions

Qty. Description

- 1
- Shows the actual liquid level
 - Alarm indication via build in buzzer

Alarm indication of:

- Power/current measurement (Optional)
- Dry running
- High water level
- Incorrect phase sequences or missing phase
- Sensor inconsistency or failure
- Intrusion detection
- Water on floor
- Too many restarts
- Pump overheating and moisture detection

As standard, the LC 241 controller has two alarm relays that can be configured using Grundfos GO to show a variety of status information on a supervisory system or PLC.

Controls:

- Fault light for system (Yes/No): N
- Communication interface module (Yes/No): N
- Hand/Off/Auto switch (Yes/No): N
- Ex barrier analog (Yes/No): N
- Ex barrier digital (Yes/No): N
- Current measurement (Yes/No): Y
- IO 241 (Yes/No): N
- Battery back-up (Yes/No): N
- Mains switch (Yes/No): N
- Electrode-relay (Yes/No): N
- RCD panel (Yes/No): N
- RCD per pump (Yes/No): N
- Circuit breaker per pump (Yes/No): N

Technical:

- Approvals: CE,EAC,UKCA,MOROCCO
- Number of pumps: 2

Materials:

- Cabinet: Metal, painted

Installation:

- Range of ambient temperature: -20 .. 45 °C
- Cabinet mounting: Wall mounting
- Earth connection: N, PE

Electrical data:

- Mains frequency: 50 / 60 Hz
- Rated voltage: 3 x 220-240/380-415 V
- Rated current: 16-44 A
- Capacitor size - run capacitor: N/A µF
- Capacitor size - starting capacitor: N/A µF
- Method of start: Star-delta (YD)
- Enclosure class (IEC 34-5): IP54
- Back-up fuse required: 100 A

Others:

- Net weight: 21.5 kg



Company name:

Created by:

Phone:

Date:

03/01/2023

Qty.	Description
------	-------------

1	Gross weight: 61.6 kg Shipping volume: 0.075 m ³ Country of origin: DK Custom tariff no.: 85371098
---	--

Description	Value
-------------	-------

General information:

Product name: LC 241 2 x 16-44 SD 3X230/400 MI OPT

Product No: 99877202

EAN number: 5713835591463

Technical:

Approvals: CE, EAC, UKCA, MOROCCO

Number of pumps: 2

Materials:

Cabinet: Metal, painted

Installation:

Range of ambient temperature: -20 .. 45 °C

Cabinet mounting: Wall mounting

Earth connection: N, PE

Electrical data:

Mains frequency: 50 / 60 Hz

Rated voltage: 3 x 220-240/380-415 V

Rated current: 16-44 A

Capacitor size - run capacitor: N/A µF

Capacitor size - starting capacitor: N/A µF

Method of start: Star-delta (YD)

Enclosure class (IEC 34-5): IP54

Back-up fuse required: 100 A

Controls:

Fault light for system (Yes/No): N

Communication interface module (Yes/No): N

Hand/Off/Auto switch (Yes/No): N

Ex barrier analog (Yes/No): N

Ex barrier digital (Yes/No): N

Current measurement (Yes/No): Y

IO 241 (Yes/No): N

Battery back-up (Yes/No): N

Mains switch (Yes/No): N

Electrode-relay (Yes/No): N

RCD panel (Yes/No): N

RCD per pump (Yes/No): N

Circuit breaker per pump (Yes/No): N

Others:

Net weight: 21.5 kg

Gross weight: 61.6 kg

Shipping volume: 0.075 m³

Sales region: Europe

Country of origin: DK

Custom tariff no.: 85371098

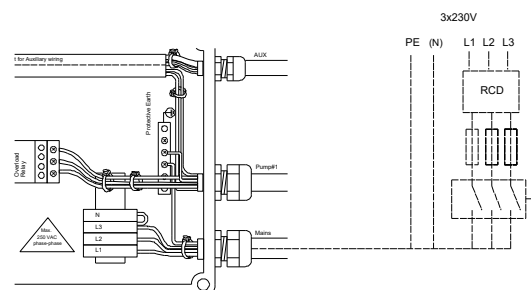
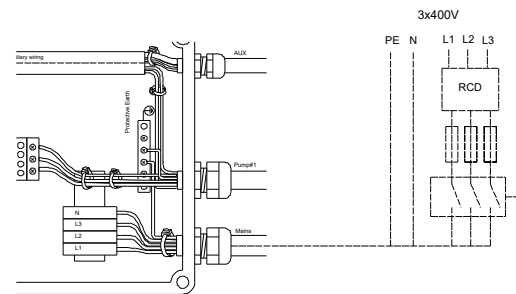
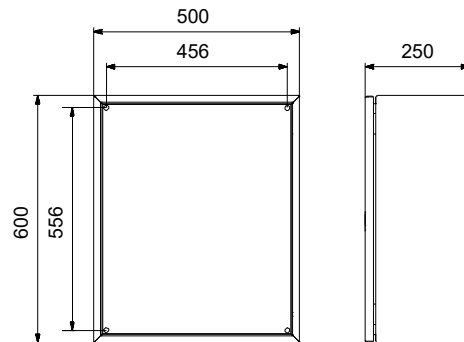

99877202 LC 241 2 x 16-44 SD 3X230/400 MI OPT

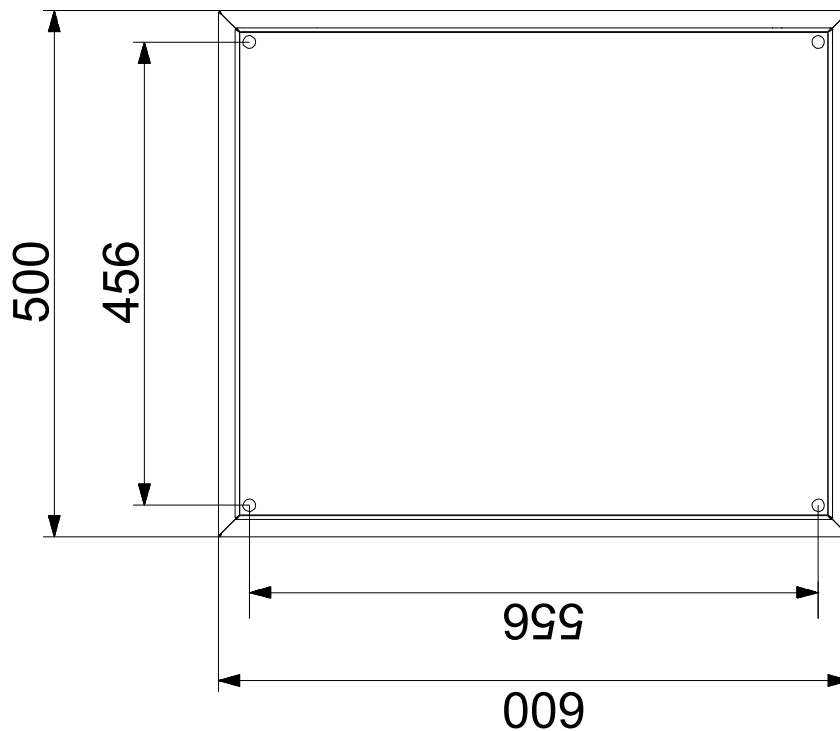
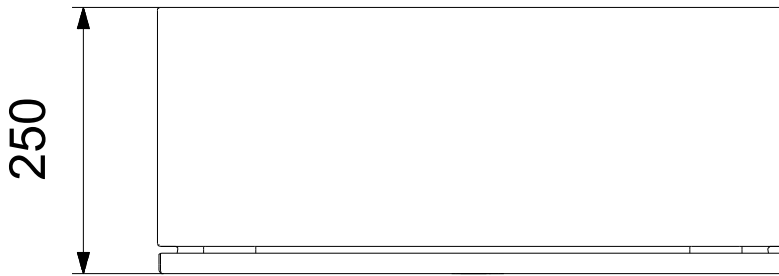

Note! All units are in [mm] unless others are stated.
Disclaimer: This simplified dimensional drawing does not show all details.

99877202 LC 241 2 x 16-44 SD 3X230/400 MI OPT

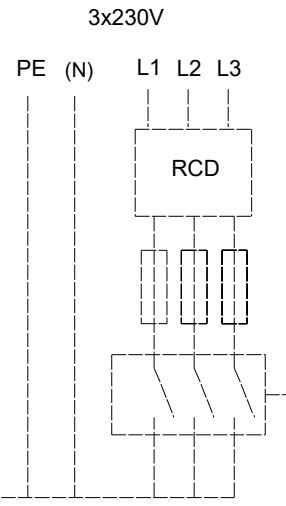
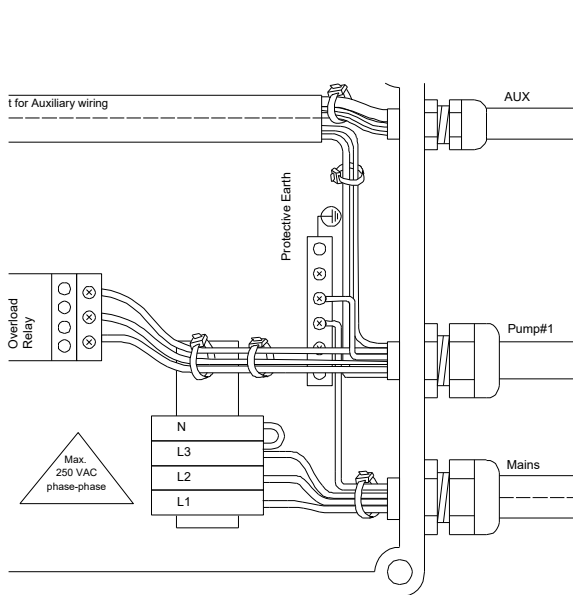
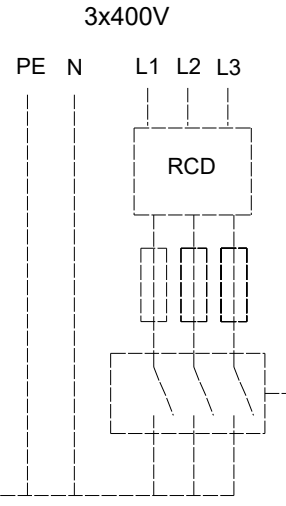
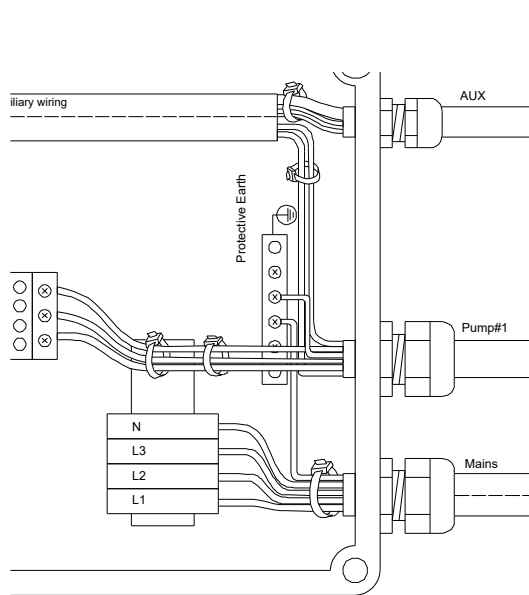

Note! All units are in [mm] unless others are stated.

