

ECO-BOOST+

COLD WATER BOOSTER SET

Trebles ECO-BOOST+ combines energy efficiency and performance whilst minimising space requirements. Manufactured with over 50 years of experience, this unit is a high quality, fully featured solution to your water boosting requirements.

Once installed the system pressure will constantly be monitored via a pressure transducer. When an outlet has been opened and a pressure drop is detected, the unit will automatically start and maintain the desired set point. Variable speed drives will only run the pump at the speed required thus saving huge amounts of energy compared to traditional methods of pump control. The touchscreen HMI combines intuitive navigation and monitoring whilst also providing BMS communication including MODBUS.

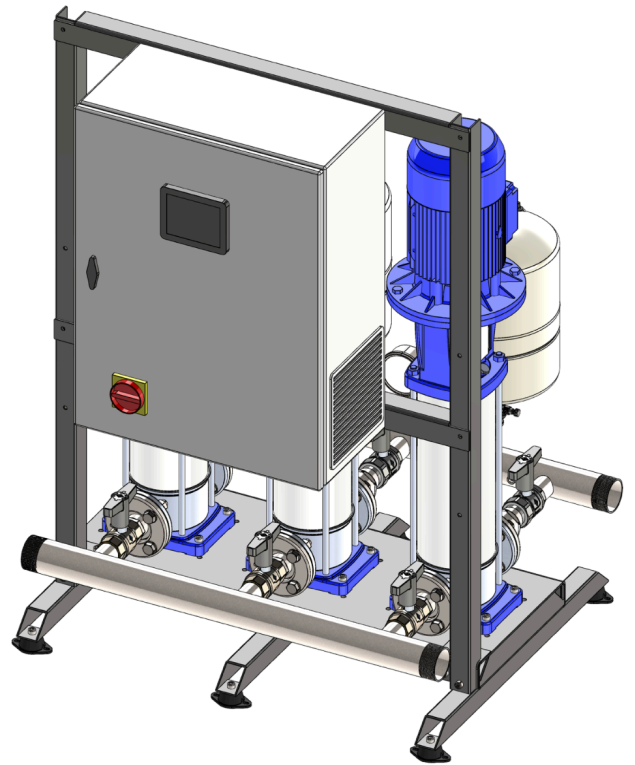

The ECO-BOOST+ range uses the latest vertical multi-stage, stainless steel pumps equipped with IE3 motors in accordance with EN standards to ensure comfort, reliability and maximum energy efficiency.

- ✓ 2 Pump / 3 Pump / 4 Pump
- ✓ Duty/Standby with Assist
- ✓ 230V* / 400V
- ✓ Auto-Changeover
- ✓ Variable Speed
- ✓ Touch Screen UI
- ✓ 2 x 24L Pressure Vessels
- ✓ Anti-Vibration Mounts
- ✓ Dry Run Protection
- ✓ Volt Free Contacts for BMS
- ✓ Hand/Off/Auto Facility
- ✓ Initial System Fill Operation
- ✓ Hours Run Indication
- ✓ Door Interlocked Isolator
- ✓ Overload Protection
- ✓ 2 Year Guarantee

* up to 2.2kW only

GENERAL CHARACTERISTICS

		5240	5241	5242
General	Pumps	2	3	4
	Mounting	Floor Mounted		
	Potable Water	Yes		
Operating Conditions	Pressure Rating	PN16		
	Ambient Temperature	-15°C / 50°C		
	Water Temperature	-10°C / 60°C		
	Relative Humidity	95% non-condensing		
Materials	Manifolds	AISI 304		
	Check Valves	AISI 304		
	Isolation Valves	CW617N UNI EN 12165		
	FlowThru Valve	CW617N UNI EN 12165		
	Fittings	AISI 304 / AISI 316		
	Transducer	AISI 304		
	Pressure Gauge	Brass Connection		
	Base / Frame	Mild Steel, Powder Coated (RAL 7016)		

CONNECTIONS

		3SV	5SV	10SV	15SV	22SV		
5240	Inlet	1-1/4" Male BSP	1-1/2" Male BSP	2" Male BSP	DN80 PN16			
	Outlet							
5241	Inlet	1-1/2" Male BSP	2" Male BSP	DN65 PN16			DN100 PN16	
	Outlet							
5242	Inlet	2" Male BSP	DN65 PN16	DN80 PN16	DN100 PN16			
	Outlet							
Vessel		1" Female BSP						
Spare Ports		1/4" Female BSP						
Notes	Male BSP	Supplied with 2 End Caps						
	DN65-DN80	Supplied with 1 End Cap and 1 Screwed Flange						
	DN100	Supplied with 2 Blind Flanges						

Example Model Code: **5241-10SV06F-INV/3**

5241	-	10	SV	06	F	-	INV	/	3
5240 2-Pump		Nominal Flow Rate (m ³ /hr) Per Pump	S Horizontal	Number of Impellers	Pump Type F Flanged R Discharge Over Suction		Control Method INV Variable Speed FS Fixed Speed		Supply Voltage 1 = 230V Single Phase 3 = 400V Three Phase
5241 3-Pump			V Multi-stage						
5242 4-Pump									

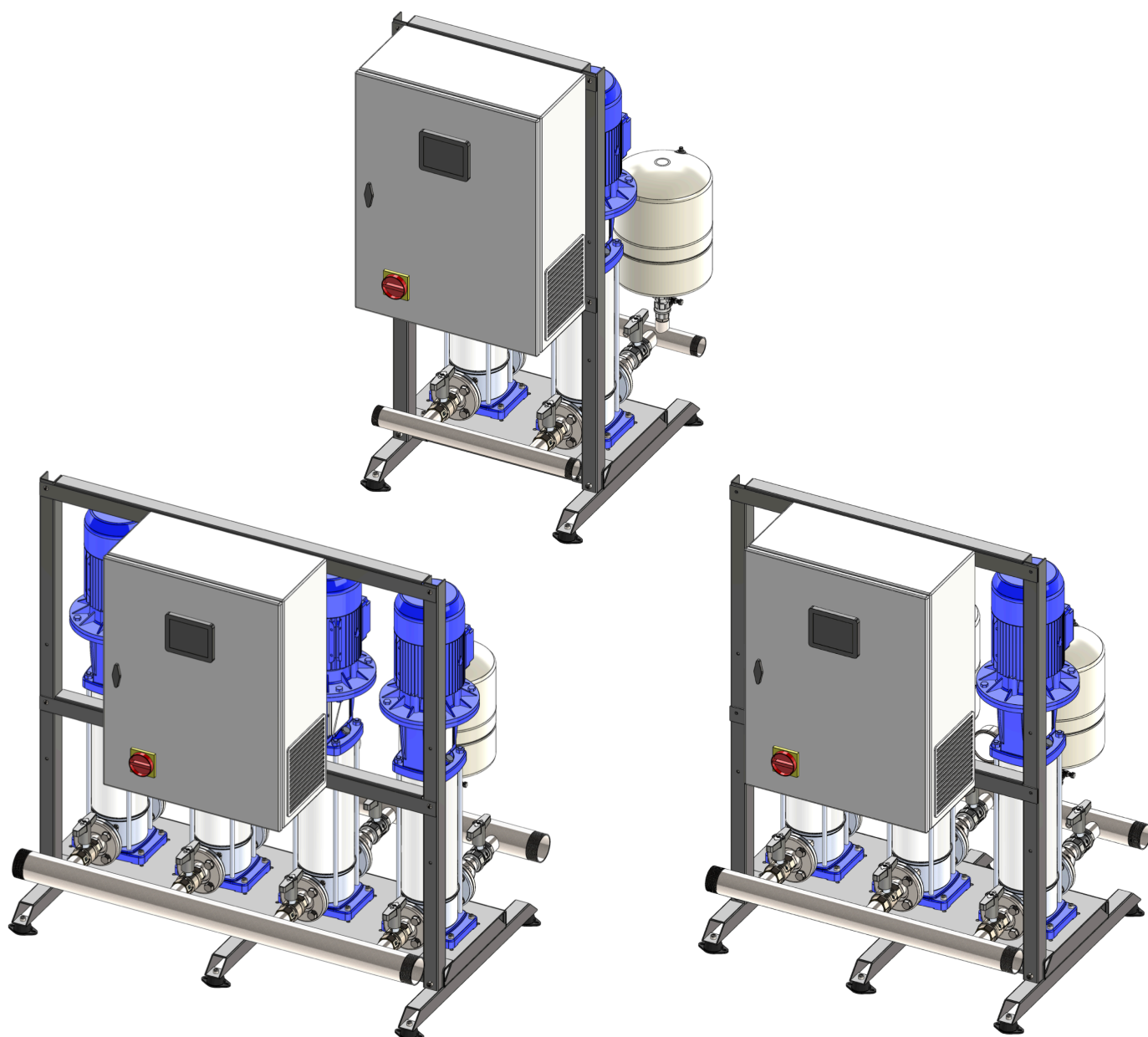

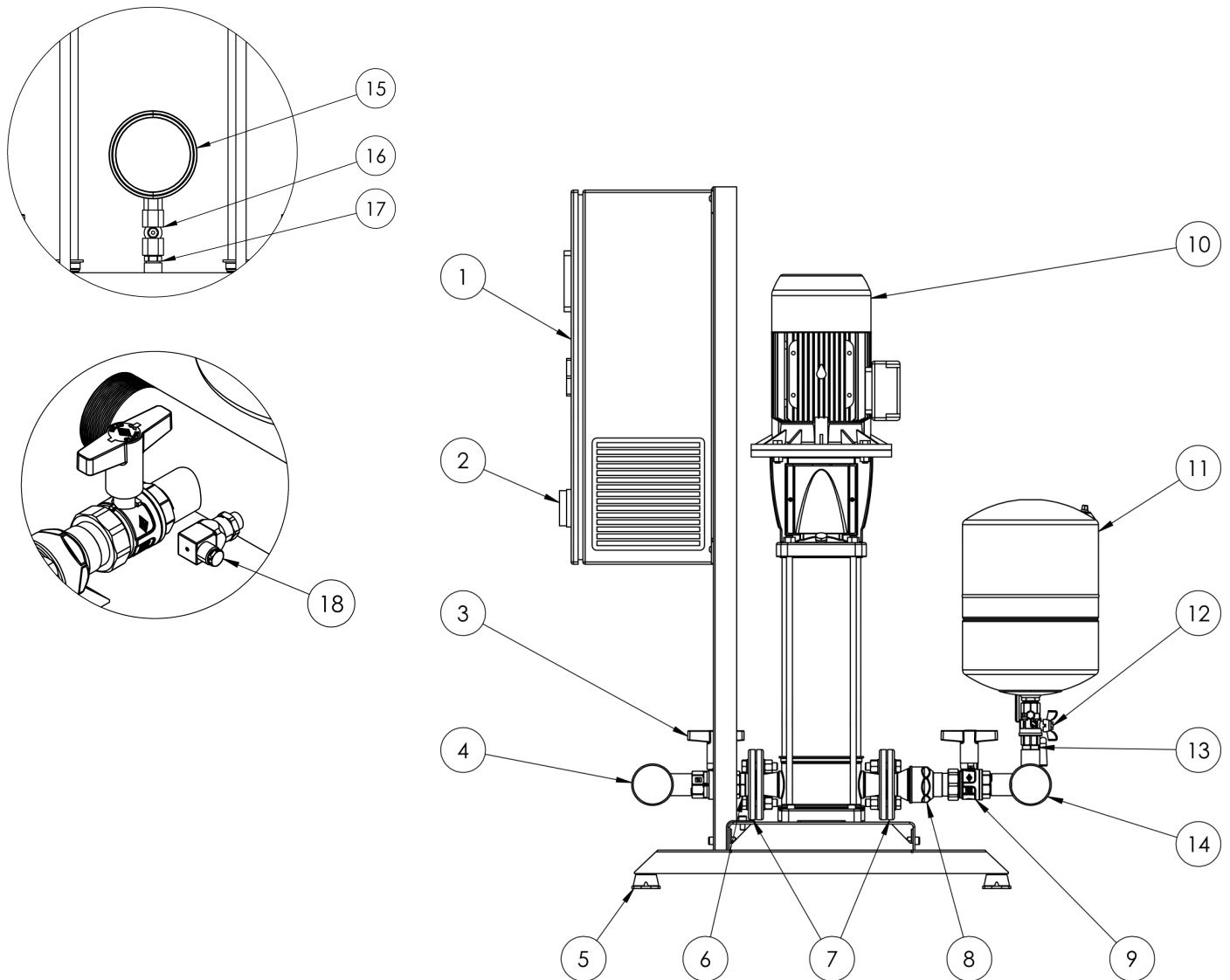

1	Control Panel	10	Vertical Multi-Stage Pump
2	Door Inter-Locked Isolator	11	Pressure Vessel (24L / 16 bar)
3	Isolation Valve	12	Vessel Isolation / Drain Valve
4	Inlet Manifold	13	Hex Nipple
5	Anti-Vibration Mounts	14	Outlet Manifold
6	Hex Nipple	15	Pressure Gauge
7	Screwed Flanges	16	Gauge Isolation Valve
8	Check Valve	17	Hex Nipple
9	Union Isolation Valve	18	Pressure Transducer

3SV04

— 1-PUMP — 2-PUMP — 3-PUMP — 4-PUMP

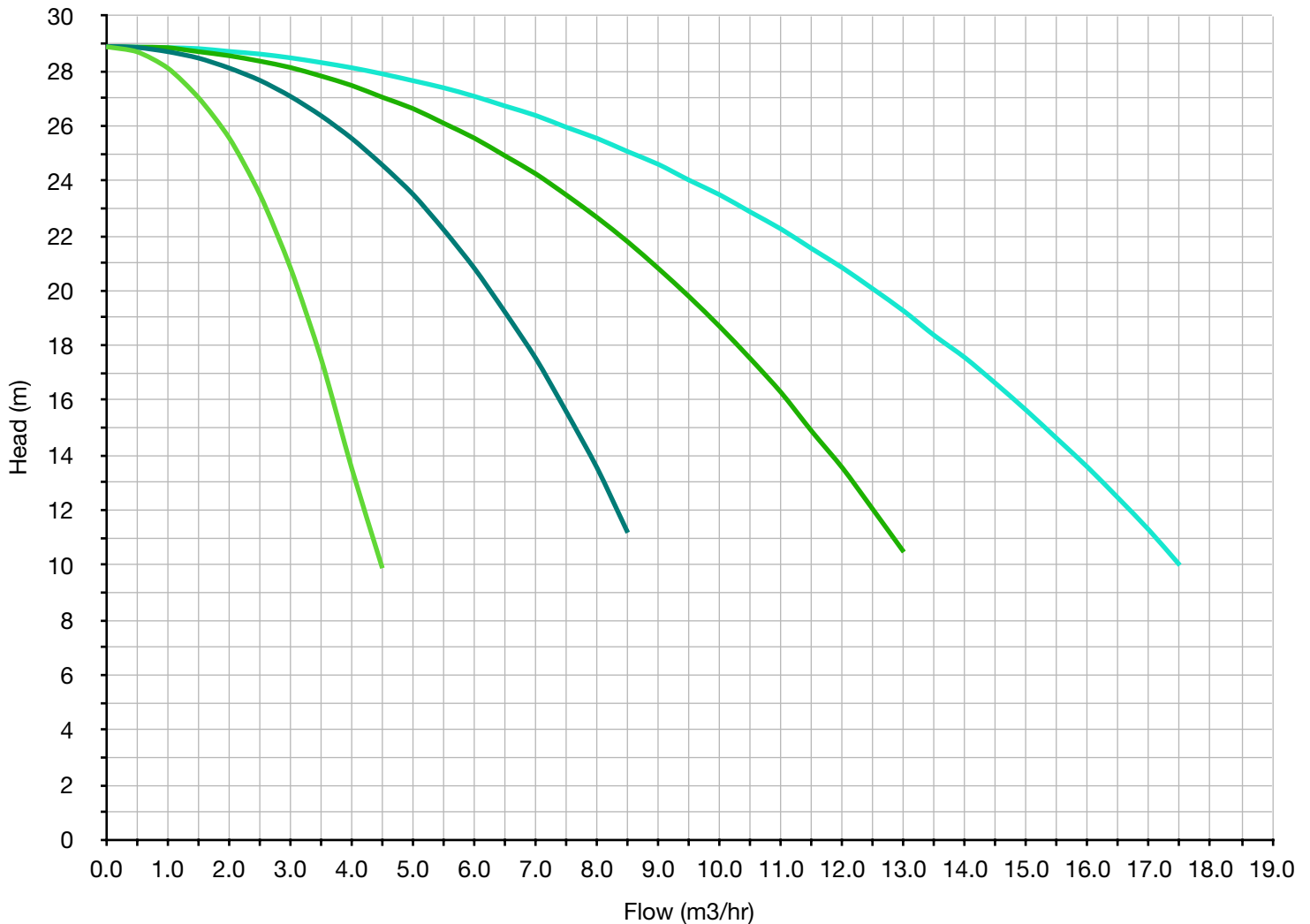

		(5240) 2-PUMP	(5241) 3-PUMP	(5242) 4-PUMP
Performance	Flow (max)	8.8 m ³ /hr	13.2 m ³ /hr	17.6 m ³ /hr
	Head (Q=0)	29m		
	Head (Qmax)	10m		
	Head (Qmin)	19m		
Electrical 230V	Supply	230/1/50		
	Power (kW)	0.37		
	Full Load Current (A)	9.0	13.1	17.1
Electrical 400V	Supply	400/3/50		
	Power (kW)	0.37		
	Full Load Current (A)	3.7	5.0	6.4

3SV06

— 1-PUMP — 2-PUMP — 3-PUMP — 4-PUMP

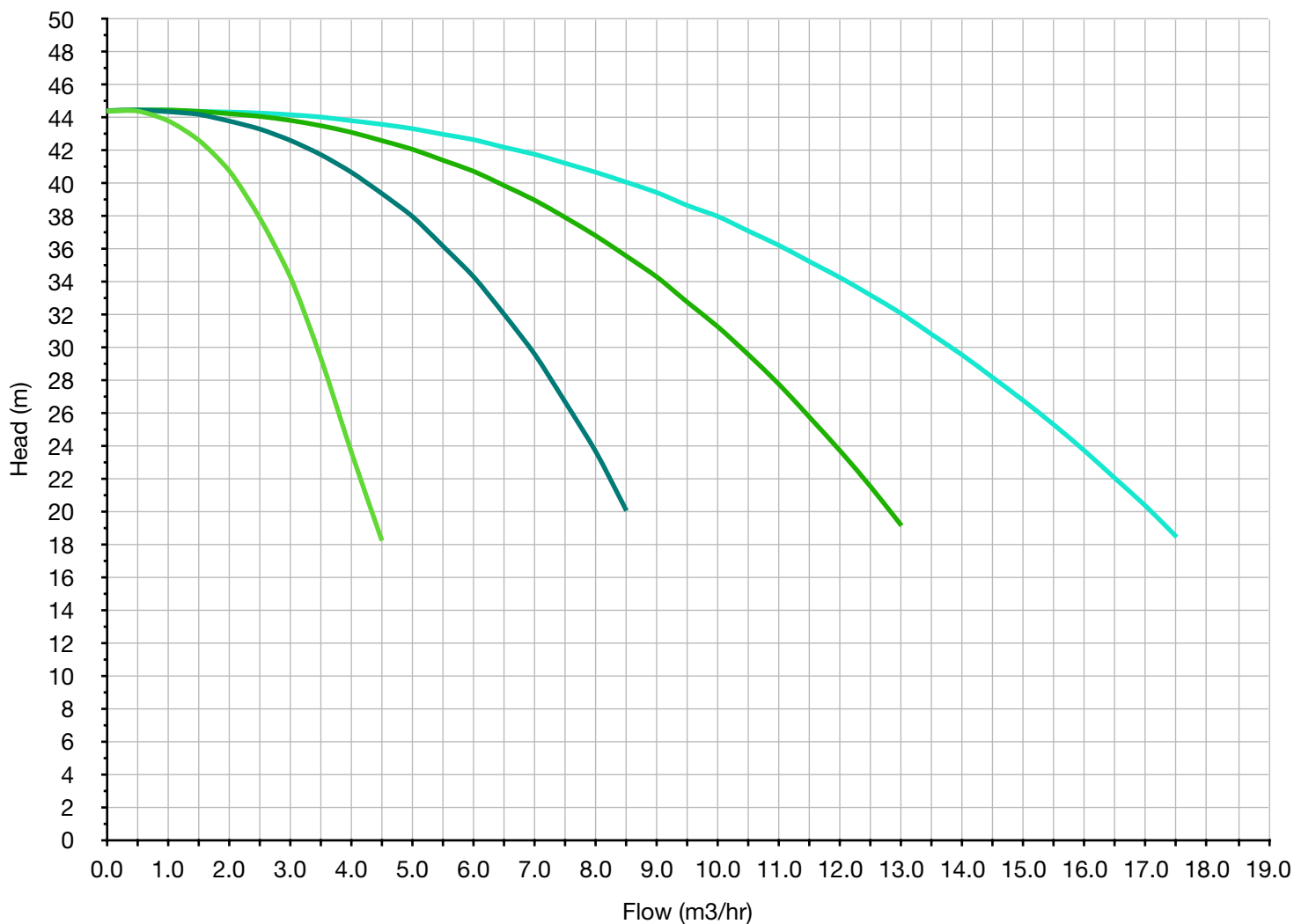

		(5240) 2-PUMP	(5241) 3-PUMP	(5242) 4-PUMP
Performance	Flow (max)	8.8 m ³ /hr	13.2 m ³ /hr	17.6 m ³ /hr
	Head (Q=0)	44m		
	Head (Qmax)	18m		
	Head (Qmin)	34m		
Electrical 230V	Supply	230/1/50		
	Power (kW)	0.55		
	Full Load Current (A)	10.1	14.6	19.2
Electrical 400V	Supply	400/3/50		
	Power (kW)	0.55		
	Full Load Current (A)	4.0	5.5	7.0

3SV08

— 1-PUMP — 2-PUMP — 3-PUMP — 4-PUMP

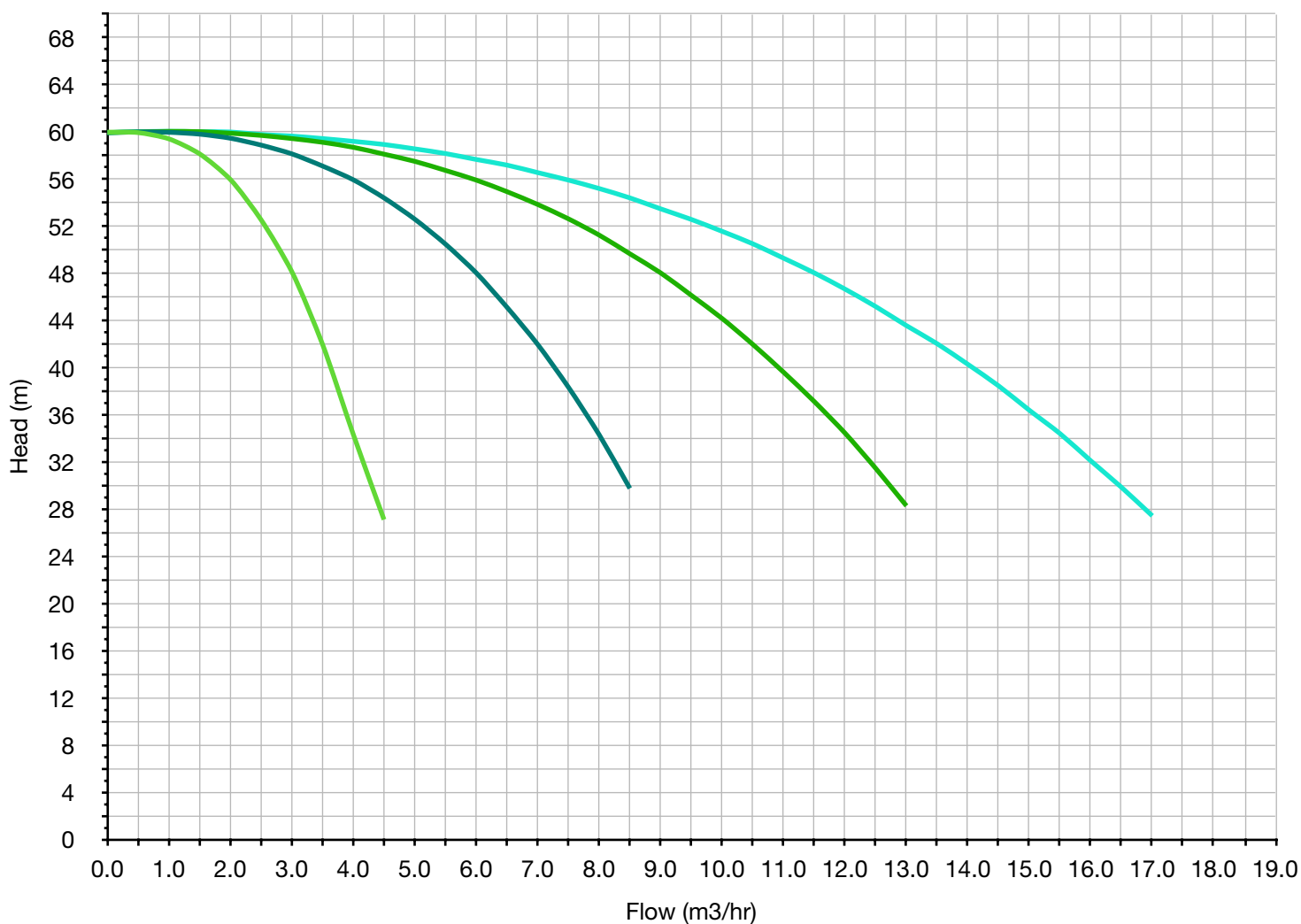

		(5240) 2-PUMP	(5241) 3-PUMP	(5242) 4-PUMP
Performance	Flow (max)	8.8 m³/hr	13.2 m³/hr	17.6 m³/hr
	Head (Q=0)	60m		
	Head (Qmax)	27m		
	Head (Qmin)	50m		
Electrical 230V	Supply	230/1/50		
	Power (kW)	0.75		
	Full Load Current (A)	11.3	16.4	21.5
Electrical 400V	Supply	400/3/50		
	Power (kW)	0.75		
	Full Load Current (A)	4.4	6.1	7.8

3SV10

— 1-PUMP — 2-PUMP — 3-PUMP — 4-PUMP

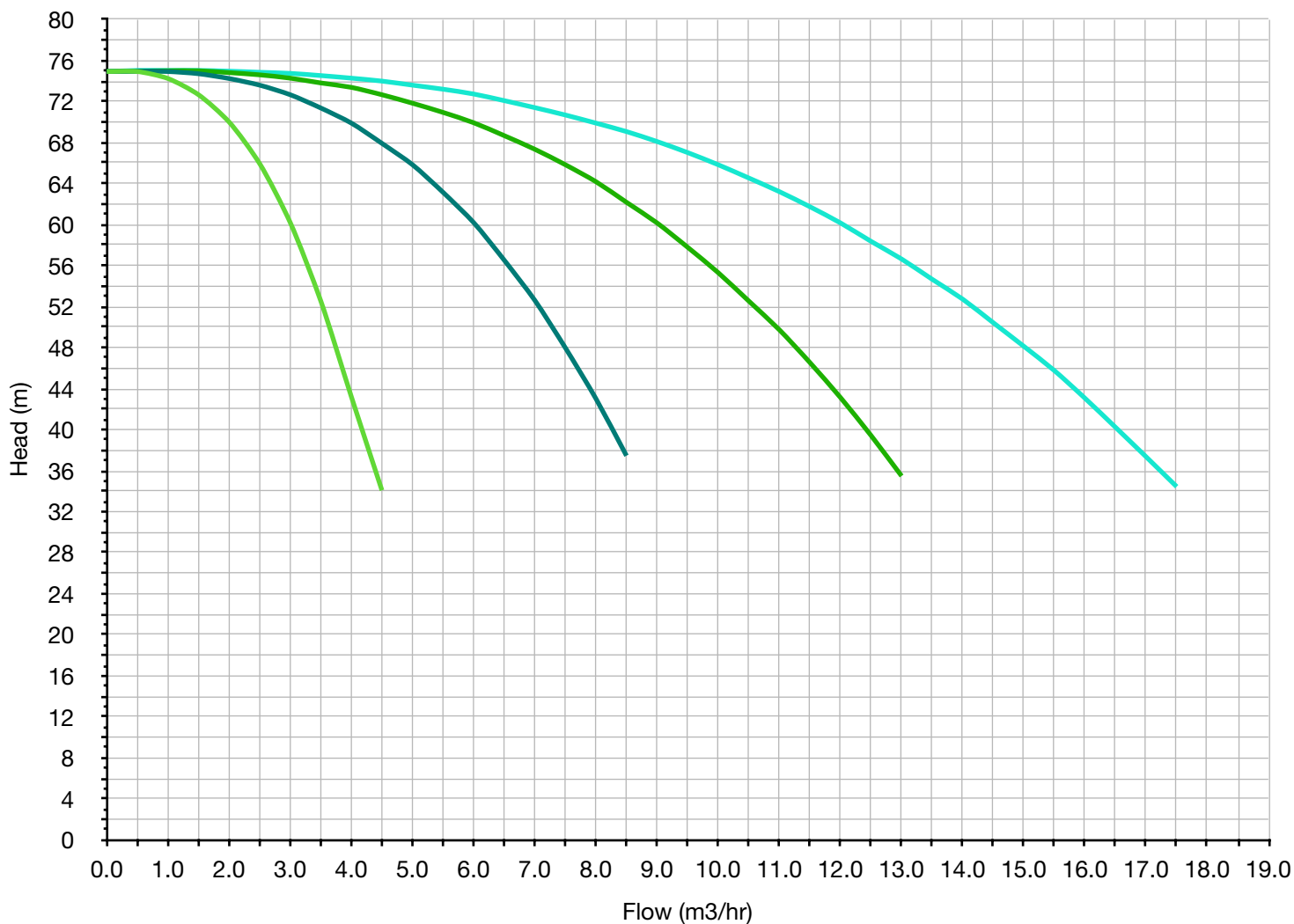

		(5240) 2-PUMP	(5241) 3-PUMP	(5242) 4-PUMP
Performance	Flow (max)	8.8 m ³ /hr	13.2 m ³ /hr	17.6 m ³ /hr
	Head (Q=0)	75m		
	Head (Qmax)	34m		
	Head (Qmin)	65m		
Electrical 230V	Supply	230/1/50		
	Power (kW)	1.1		
	Full Load Current (A)	15.4	22.6	29.8
Electrical 400V	Supply	400/3/50		
	Power (kW)	1.1		
	Full Load Current (A)	5.8	8.2	10.6

3SV12

— 1-PUMP — 2-PUMP — 3-PUMP — 4-PUMP

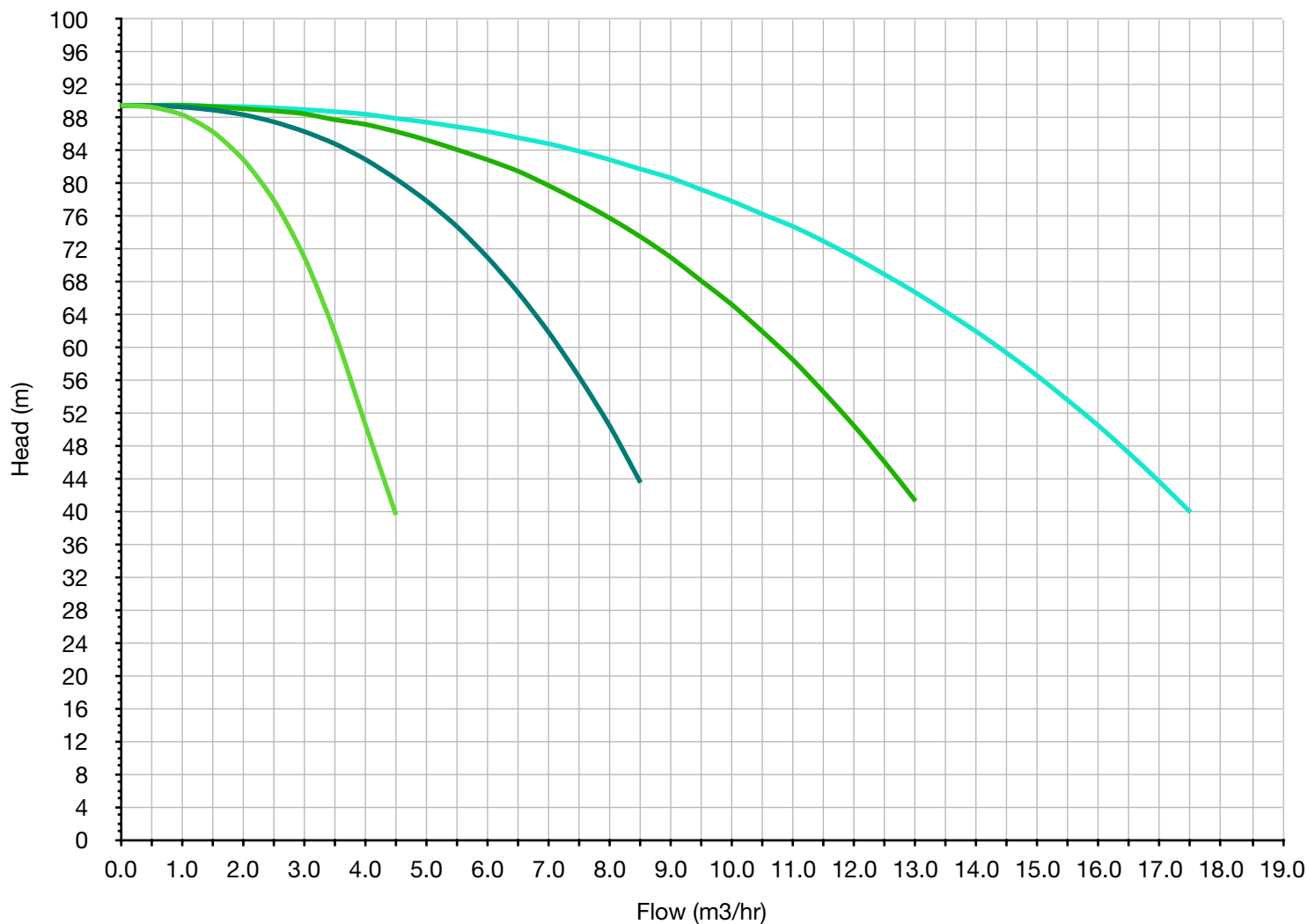

		(5240) 2-PUMP	(5241) 3-PUMP	(5242) 4-PUMP
Performance	Flow (max)	8.8 m³/hr	13.2 m³/hr	17.6 m³/hr
	Head (Q=0)	90m		
	Head (Qmax)	39m		
	Head (Qmin)	80m		
Electrical 230V	Supply	230/1/50		
	Power (kW)	1.1		
	Full Load Current (A)	15.4	22.6	29.8
Electrical 400V	Supply	400/3/50		
	Power (kW)	1.1		
	Full Load Current (A)	5.8	8.2	10.6

3SV14

— 1-PUMP — 2-PUMP — 3-PUMP — 4-PUMP

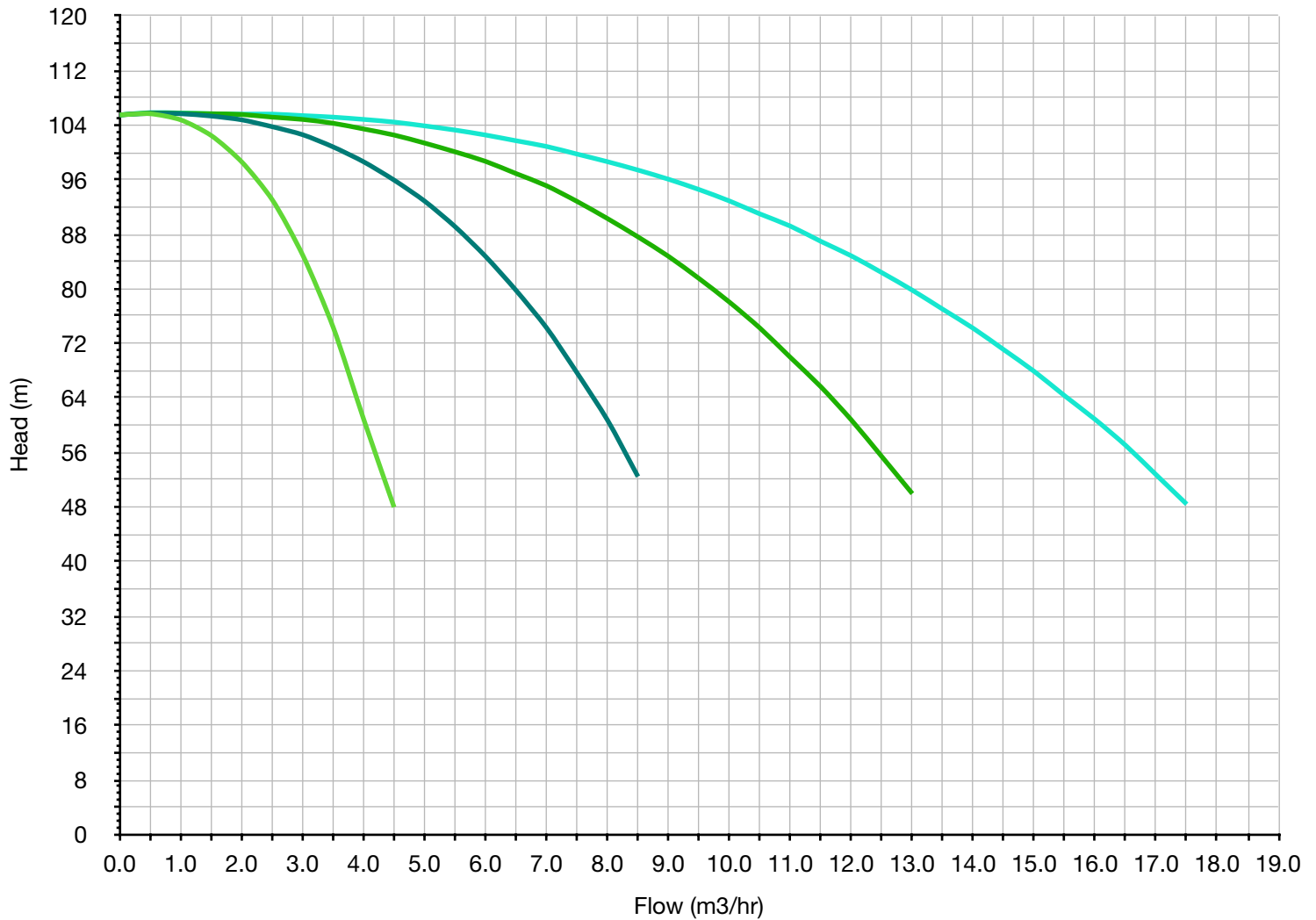

		(5240) 2-PUMP	(5241) 3-PUMP	(5242) 4-PUMP
Performance	Flow (max)	8.8 m ³ /hr	13.2 m ³ /hr	17.6 m ³ /hr
	Head (Q=0)	110m		
	Head (Qmax)	48m		
	Head (Qmin)	100m		
Electrical 230V	Supply	230/1/50		
	Power (kW)	1.5		
	Full Load Current (A)	20.1	29.6	39.2
Electrical 400V	Supply	400/3/50		
	Power (kW)	1.5		
	Full Load Current (A)	7.4	10.5	13.7

3SV16

— 1-PUMP — 2-PUMP — 3-PUMP — 4-PUMP

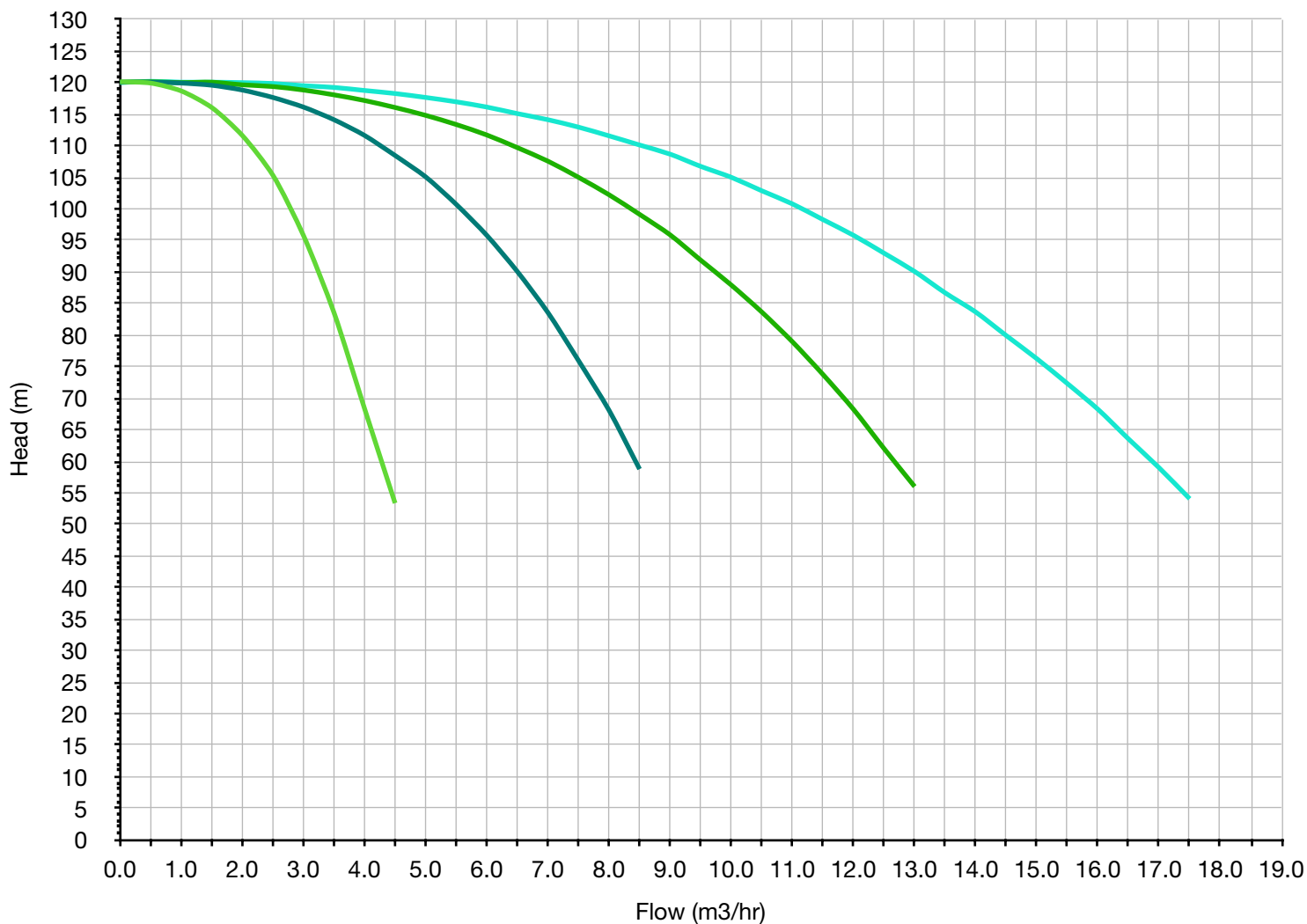

		(5240) 2-PUMP	(5241) 3-PUMP	(5242) 4-PUMP
Performance	Flow (max)	8.8 m ³ /hr	13.2 m ³ /hr	17.6 m ³ /hr
	Head (Q=0)	120m		
	Head (Qmax)	53m		
	Head (Qmin)	110m		
Electrical 230V	Supply	230/1/50		
	Power (kW)	1.5		
	Full Load Current (A)	20.1	29.6	39.2
Electrical 400V	Supply	400/3/50		
	Power (kW)	1.5		
	Full Load Current (A)	7.4	10.5	13.7

3SV19

— 1-PUMP — 2-PUMP — 3-PUMP — 4-PUMP

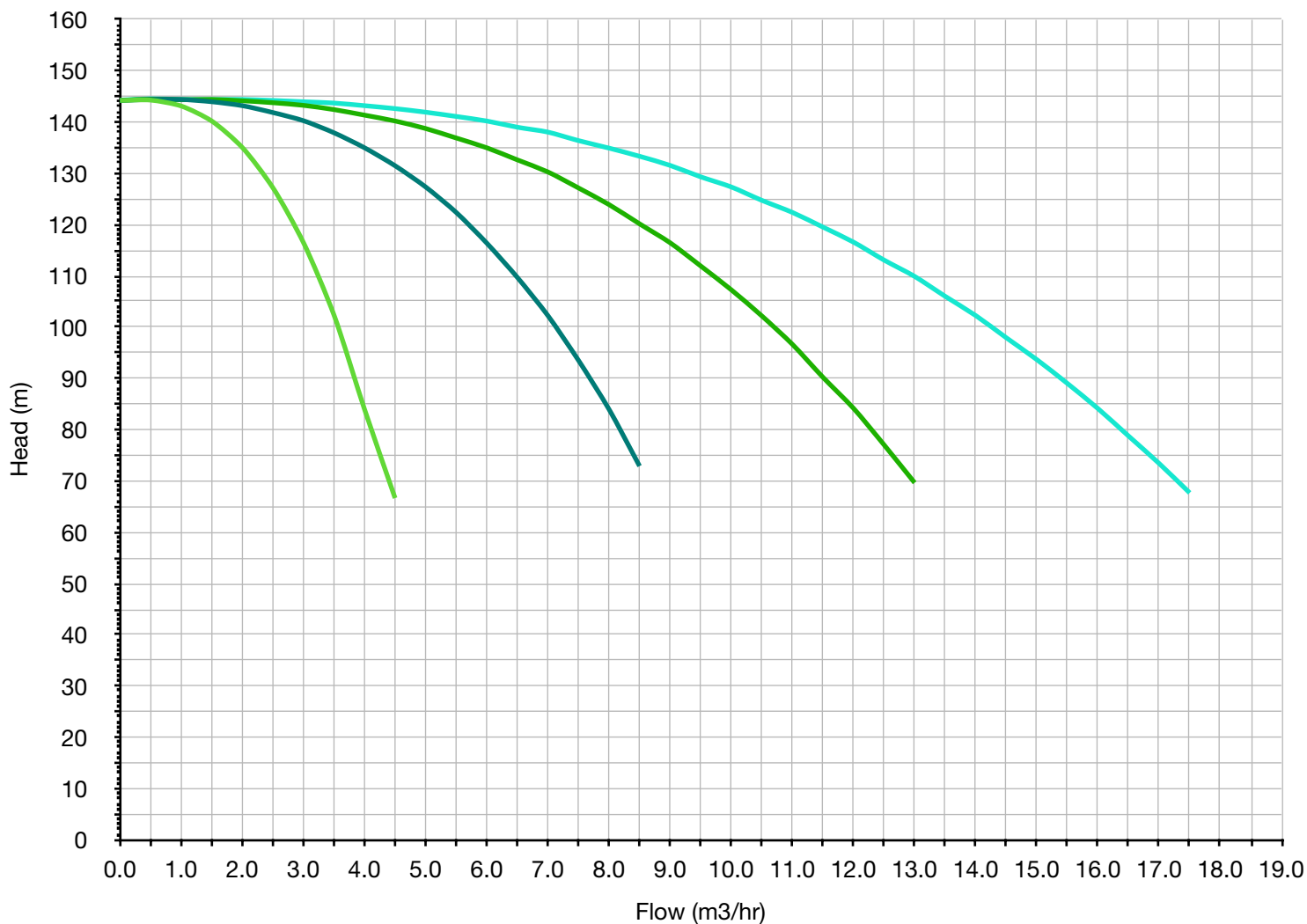

		(5240) 2-PUMP	(5241) 3-PUMP	(5242) 4-PUMP
Performance	Flow (max)	8.8 m ³ /hr	13.2 m ³ /hr	17.6 m ³ /hr
	Head (Q=0)	140m		
	Head (Qmax)	67m		
	Head (Qmin)	130m		
Electrical 230V	Supply	230/1/50		
	Power (kW)	2.2		
	Full Load Current (A)	28.6	42.5	56.3
Electrical 400V	Supply	400/3/50		
	Power (kW)	2.2		
	Full Load Current (A)	10.2	14.8	19.4

3SV21

— 1-PUMP — 2-PUMP — 3-PUMP — 4-PUMP

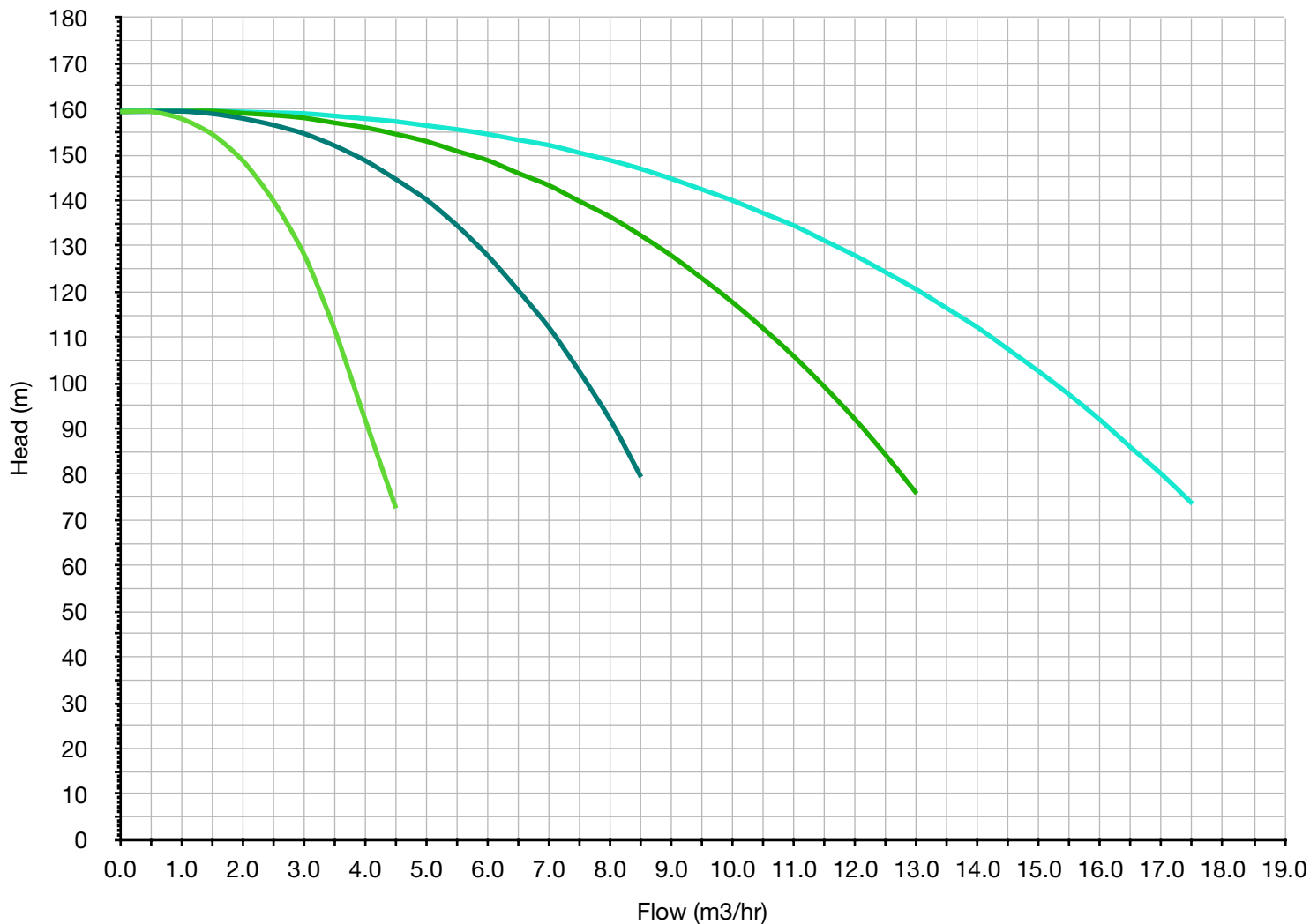

		(5240) 2-PUMP	(5241) 3-PUMP	(5242) 4-PUMP
Performance	Flow (max)	8.8 m ³ /hr	13.2 m ³ /hr	17.6 m ³ /hr
	Head (Q=0)	160m		
	Head (Qmax)	72m		
	Head (Qmin)	150m		
Electrical 230V	Supply	230/1/50		
	Power (kW)	2.2		
	Full Load Current (A)	28.6	42.5	56.3
Electrical 400V	Supply	400/3/50		
	Power (kW)	2.2		
	Full Load Current (A)	10.2	14.8	19.4

5SV04

— 1-PUMP — 2-PUMP — 3-PUMP — 4-PUMP

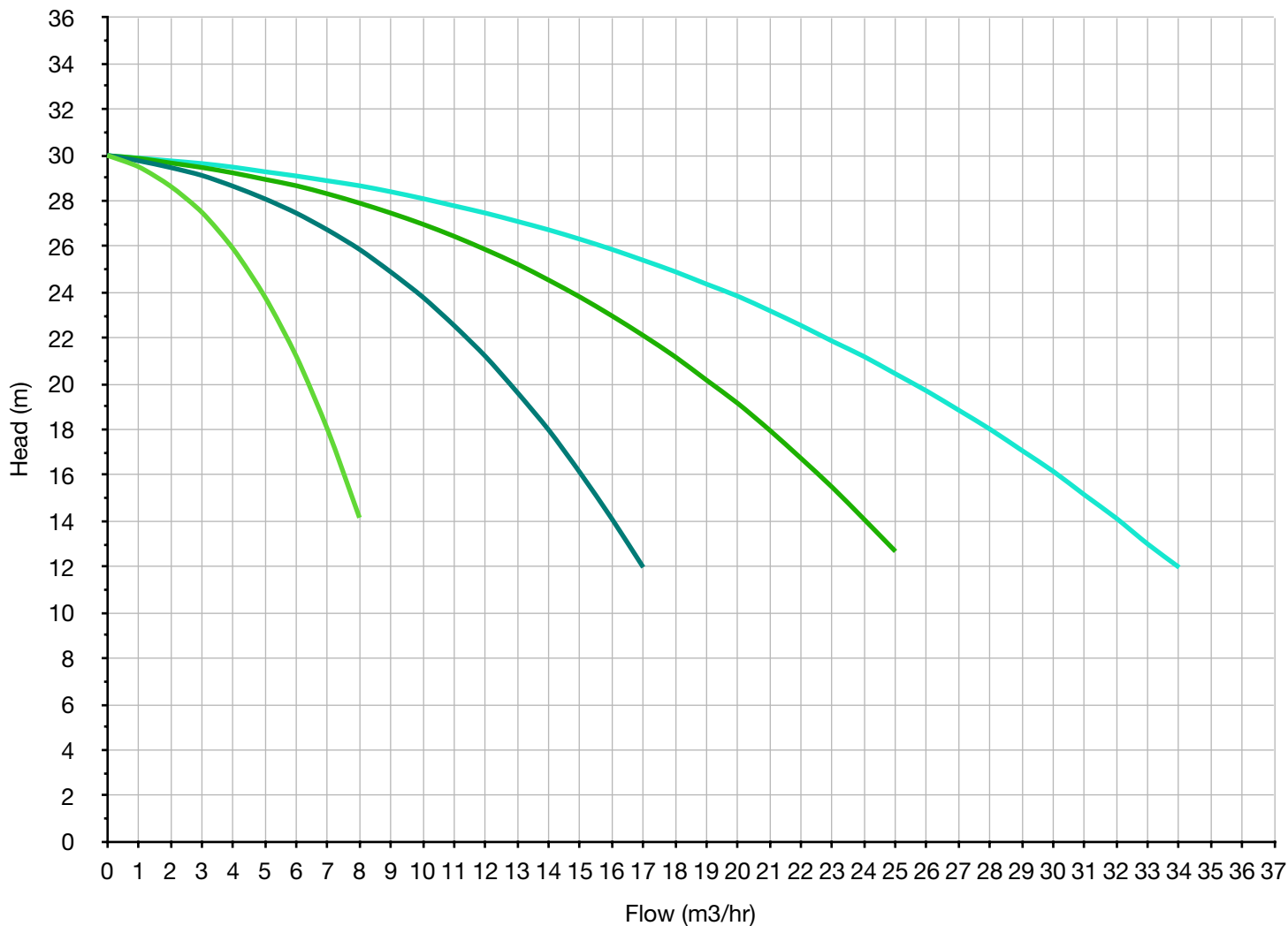

		(5240) 2-PUMP	(5241) 3-PUMP	(5242) 4-PUMP
Performance	Flow (max)	17.0 m ³ /hr	25.5 m ³ /hr	34.0 m ³ /hr
	Head (Q=0)	30m		
	Head (Qmax)	12m		
	Head (Qmin)	20m		
Electrical 230V	Supply	230/1/50		
	Power (kW)	0.55		
	Full Load Current (A)	10.1	14.6	19.2
Electrical 400V	Supply	400/3/50		
	Power (kW)	0.55		
	Full Load Current (A)	4.0	5.5	7.0

5SV06

— 1-PUMP — 2-PUMP — 3-PUMP — 4-PUMP

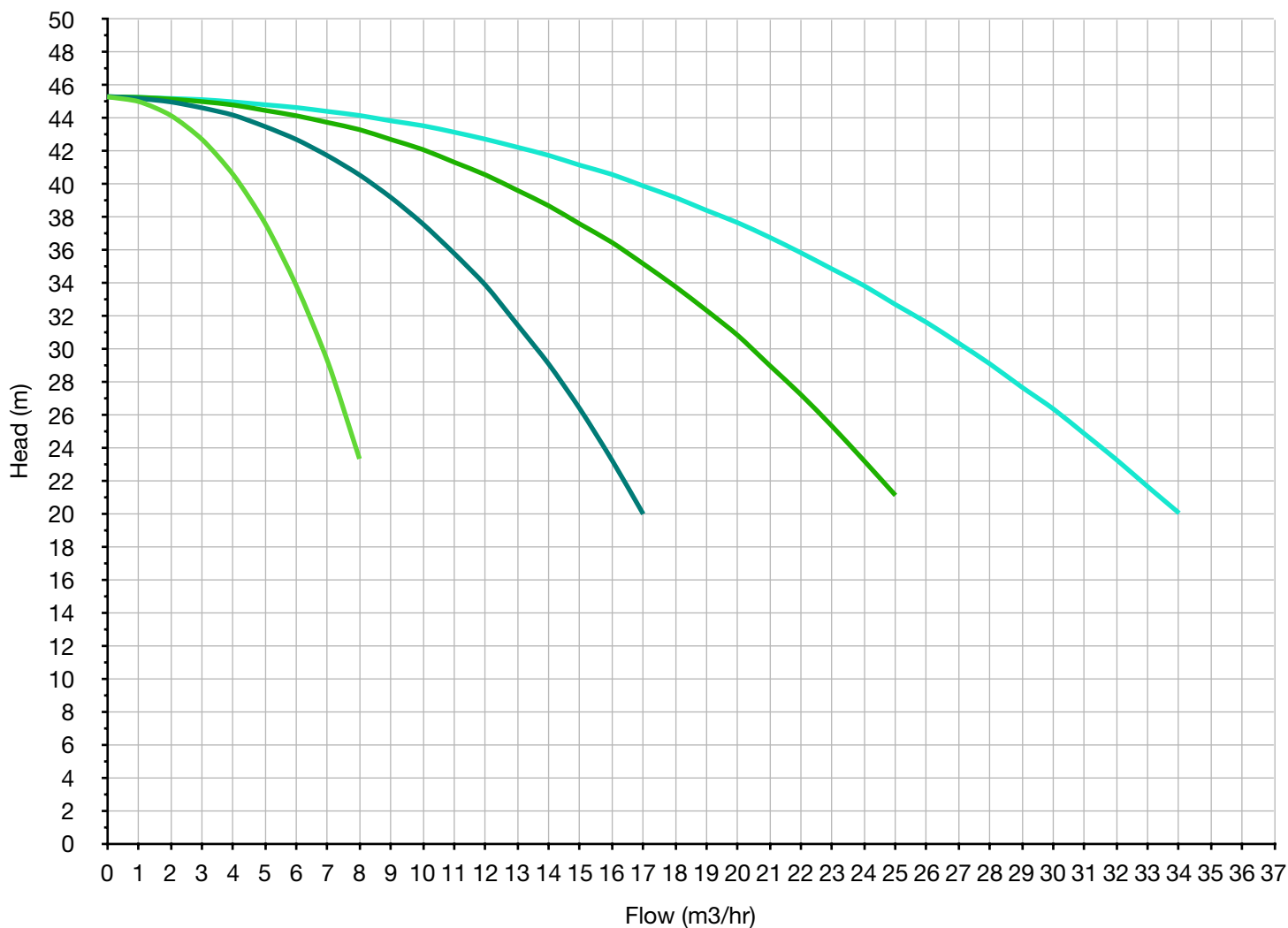

		(5240) 2-PUMP	(5241) 3-PUMP	(5242) 4-PUMP
Performance	Flow (max)	17.0 m³/hr	25.5 m³/hr	34.0 m³/hr
	Head (Q=0)	45m		
	Head (Qmax)	20m		
	Head (Qmin)	35m		
Electrical 230V	Supply	230/1/50		
	Power (kW)	1.1		
	Full Load Current (A)	15.4	22.6	29.8
Electrical 400V	Supply	400/3/50		
	Power (kW)	1.1		
	Full Load Current (A)	5.8	8.2	10.6

5SV08

— 1-PUMP — 2-PUMP — 3-PUMP — 4-PUMP

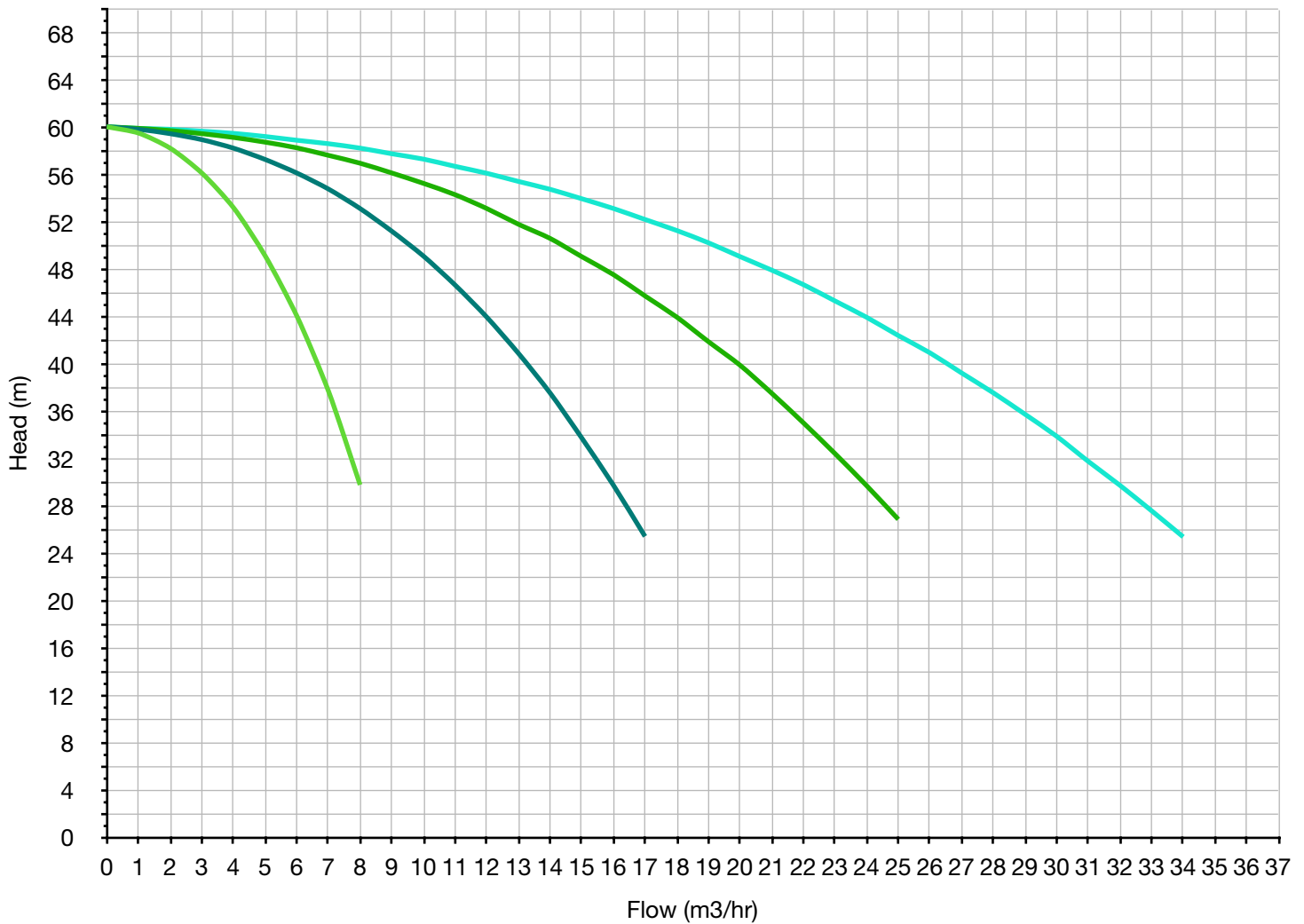

		(5240) 2-PUMP	(5241) 3-PUMP	(5242) 4-PUMP
Performance	Flow (max)	17.0 m ³ /hr	25.5 m ³ /hr	34.0 m ³ /hr
	Head (Q=0)	60m		
	Head (Qmax)	25m		
	Head (Qmin)	50m		
Electrical 230V	Supply	230/1/50		
	Power (kW)	1.1		
	Full Load Current (A)	15.4	22.6	29.8
Electrical 400V	Supply	400/3/50		
	Power (kW)	1.1		
	Full Load Current (A)	5.8	8.2	10.6

5SV10

— 1-PUMP — 2-PUMP — 3-PUMP — 4-PUMP

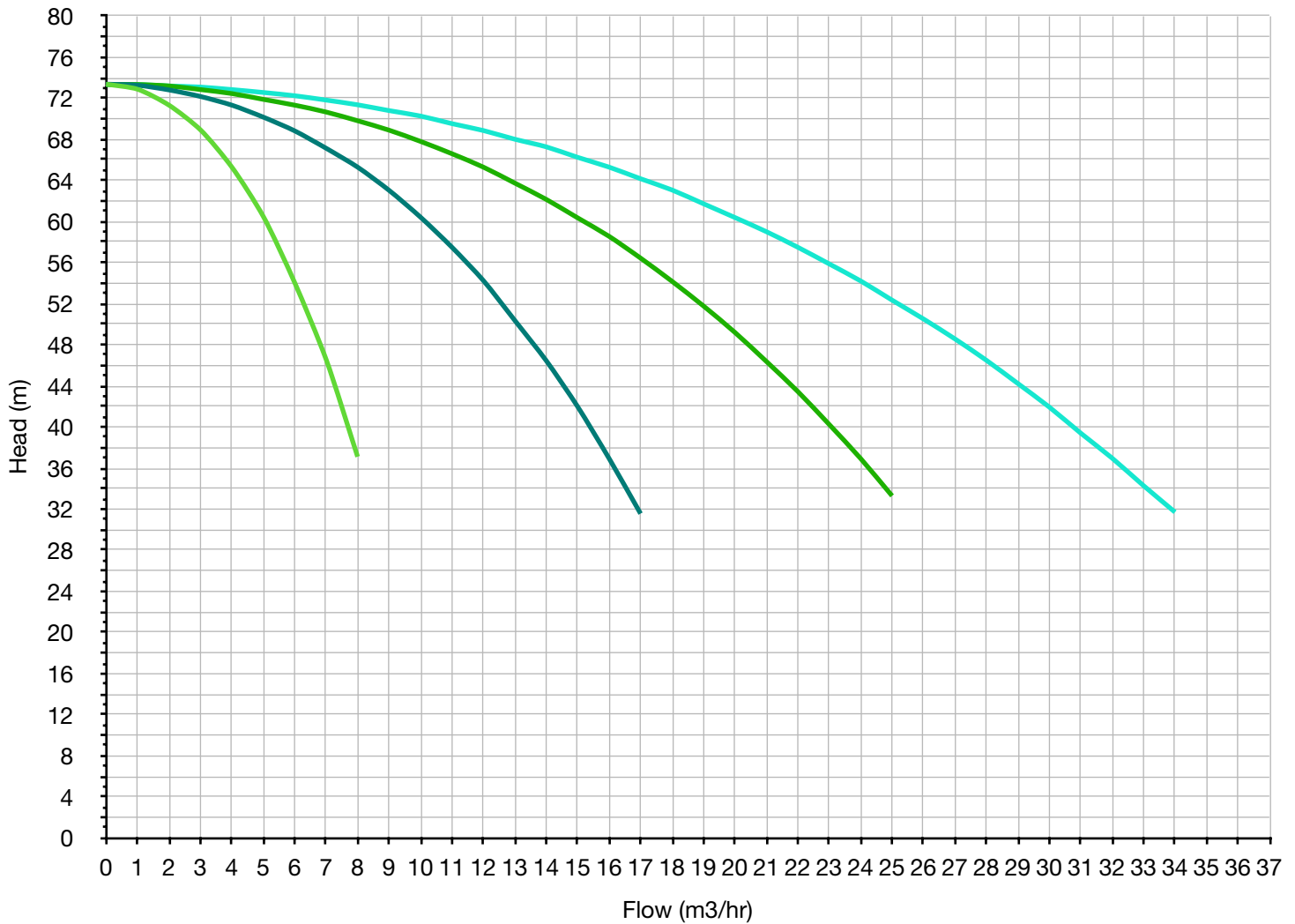

		(5240) 2-PUMP	(5241) 3-PUMP	(5242) 4-PUMP
Performance	Flow (max)	17.0 m³/hr	25.5 m³/hr	34.0 m³/hr
	Head (Q=0)	75m		
	Head (Qmax)	33m		
	Head (Qmin)	65m		
Electrical 230V	Supply	230/1/50		
	Power (kW)	1.5		
	Full Load Current (A)	20.1	29.6	39.2
Electrical 400V	Supply	400/3/50		
	Power (kW)	1.5		
	Full Load Current (A)	7.4	10.5	13.7

5SV12

— 1-PUMP — 2-PUMP — 3-PUMP — 4-PUMP

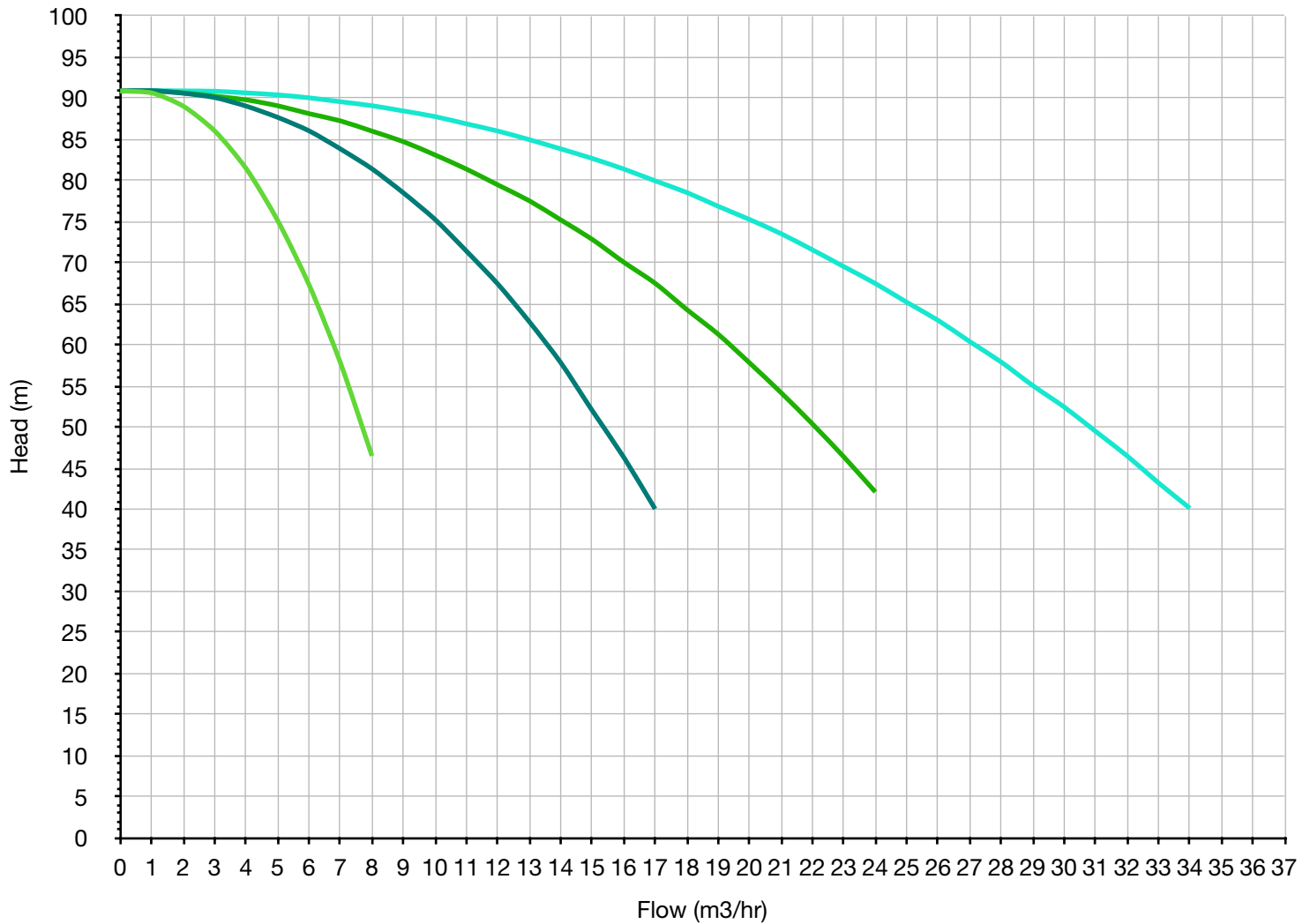

		(5240) 2-PUMP	(5241) 3-PUMP	(5242) 4-PUMP
Performance	Flow (max)	17.0 m ³ /hr	25.5 m ³ /hr	34.0 m ³ /hr
	Head (Q=0)	91m		
	Head (Qmax)	40m		
	Head (Qmin)	81m		
Electrical 230V	Supply	230/1/50		
	Power (kW)	2.2		
	Full Load Current (A)	28.6	42.5	56.3
Electrical 400V	Supply	400/3/50		
	Power (kW)	2.2		
	Full Load Current (A)	10.2	14.8	19.4

5SV14

— 1-PUMP — 2-PUMP — 3-PUMP — 4-PUMP

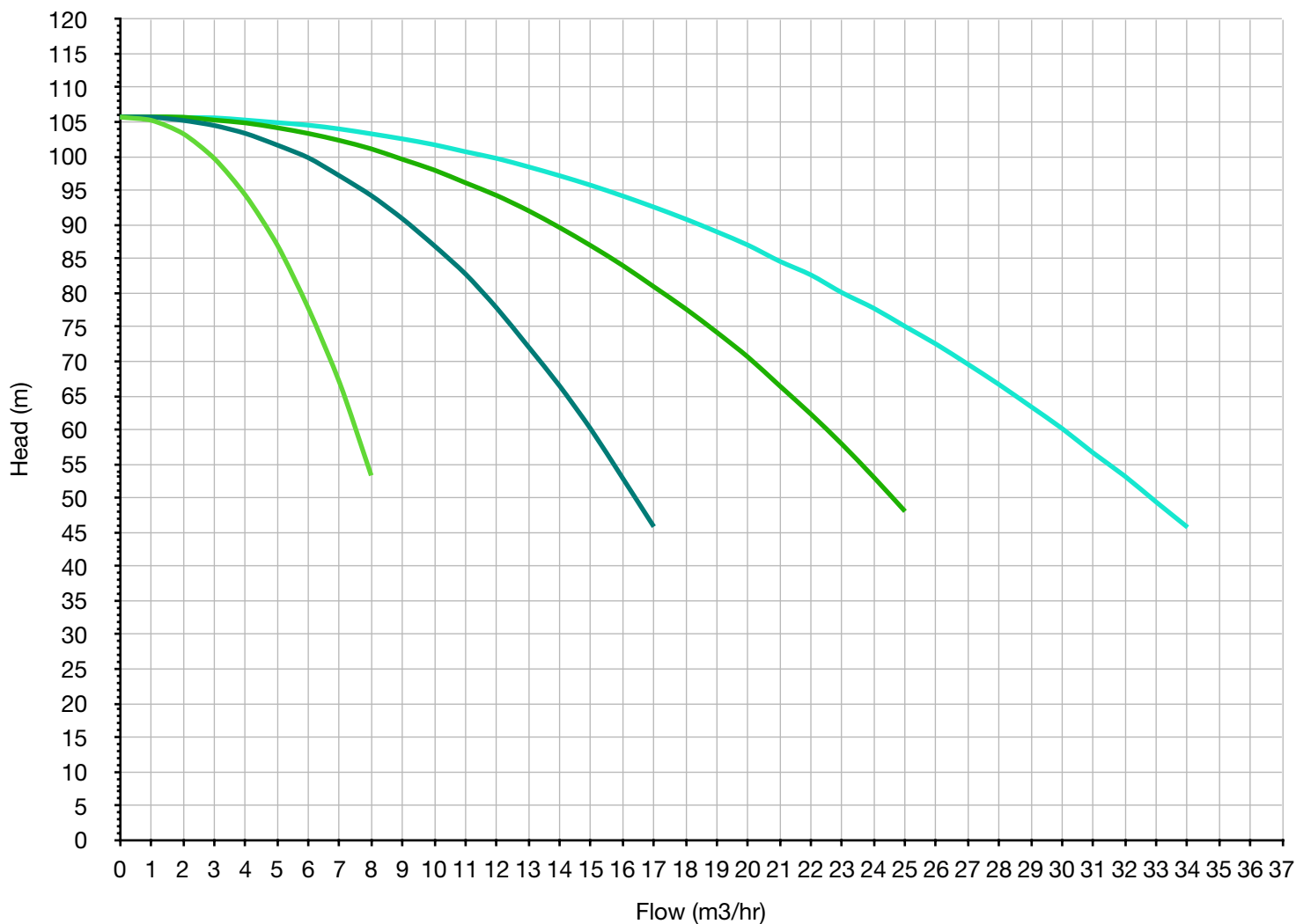

		(5240) 2-PUMP	(5241) 3-PUMP	(5242) 4-PUMP
Performance	Flow (max)	17.0 m ³ /hr	25.5 m ³ /hr	34.0 m ³ /hr
	Head (Q=0)	106m		
	Head (Qmax)	46m		
	Head (Qmin)	96m		
Electrical 230V	Supply	230/1/50		
	Power (kW)	2.2		
	Full Load Current (A)	28.6	42.5	56.3
Electrical 400V	Supply	400/3/50		
	Power (kW)	2.2		
	Full Load Current (A)	10.2	14.8	19.4

5SV16

— 1-PUMP — 2-PUMP — 3-PUMP — 4-PUMP

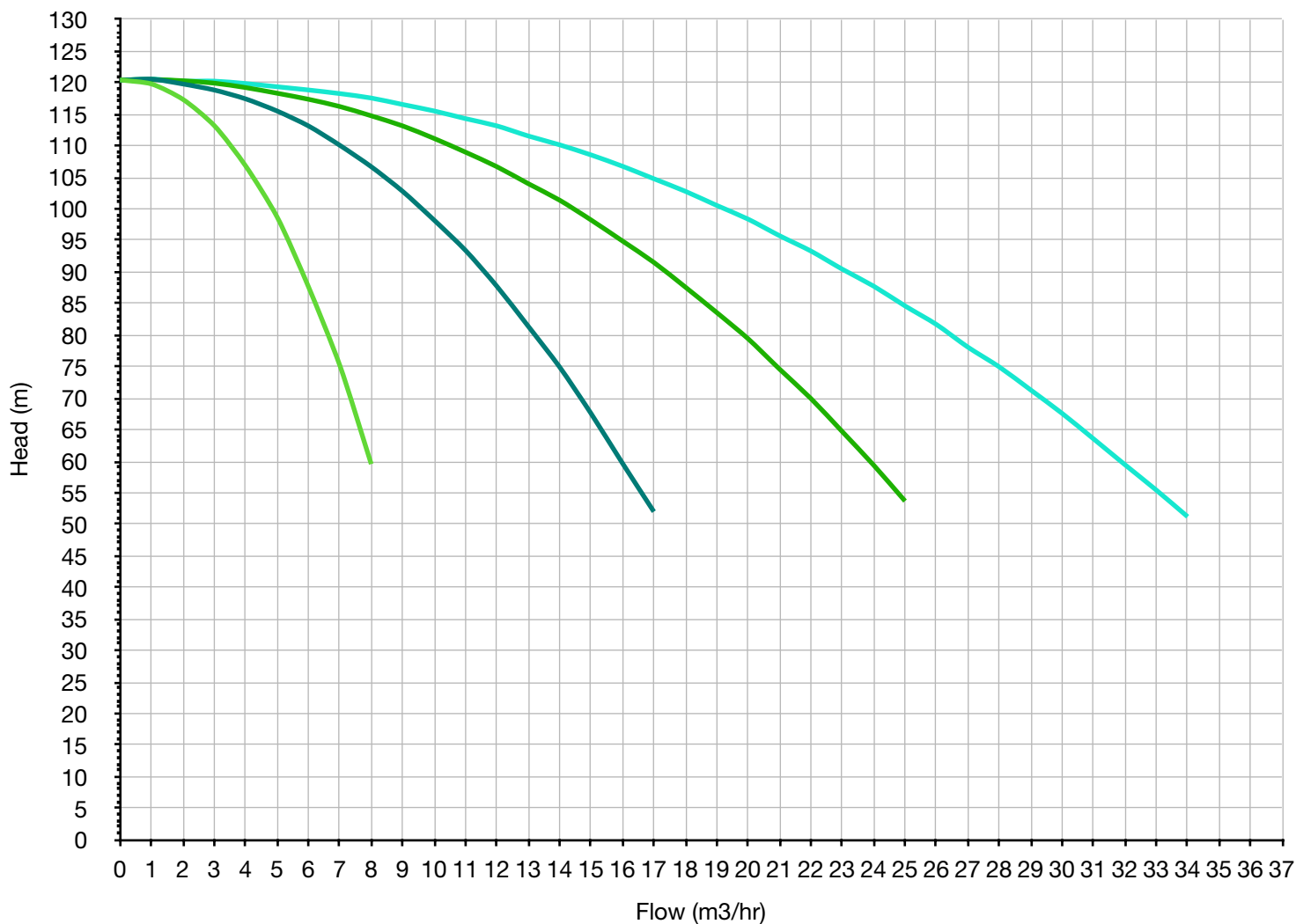

		(5240) 2-PUMP	(5241) 3-PUMP	(5242) 4-PUMP
Performance	Flow (max)	17.0 m ³ /hr	25.5 m ³ /hr	34.0 m ³ /hr
	Head (Q=0)	120m		
	Head (Qmax)	51m		
	Head (Qmin)	110m		
Electrical 230V	Supply	230/1/50		
	Power (kW)	2.2		
	Full Load Current (A)	28.6	42.5	56.3
Electrical 400V	Supply	400/3/50		
	Power (kW)	2.2		
	Full Load Current (A)	10.2	14.8	19.4

5SV18

— 1-PUMP — 2-PUMP — 3-PUMP — 4-PUMP

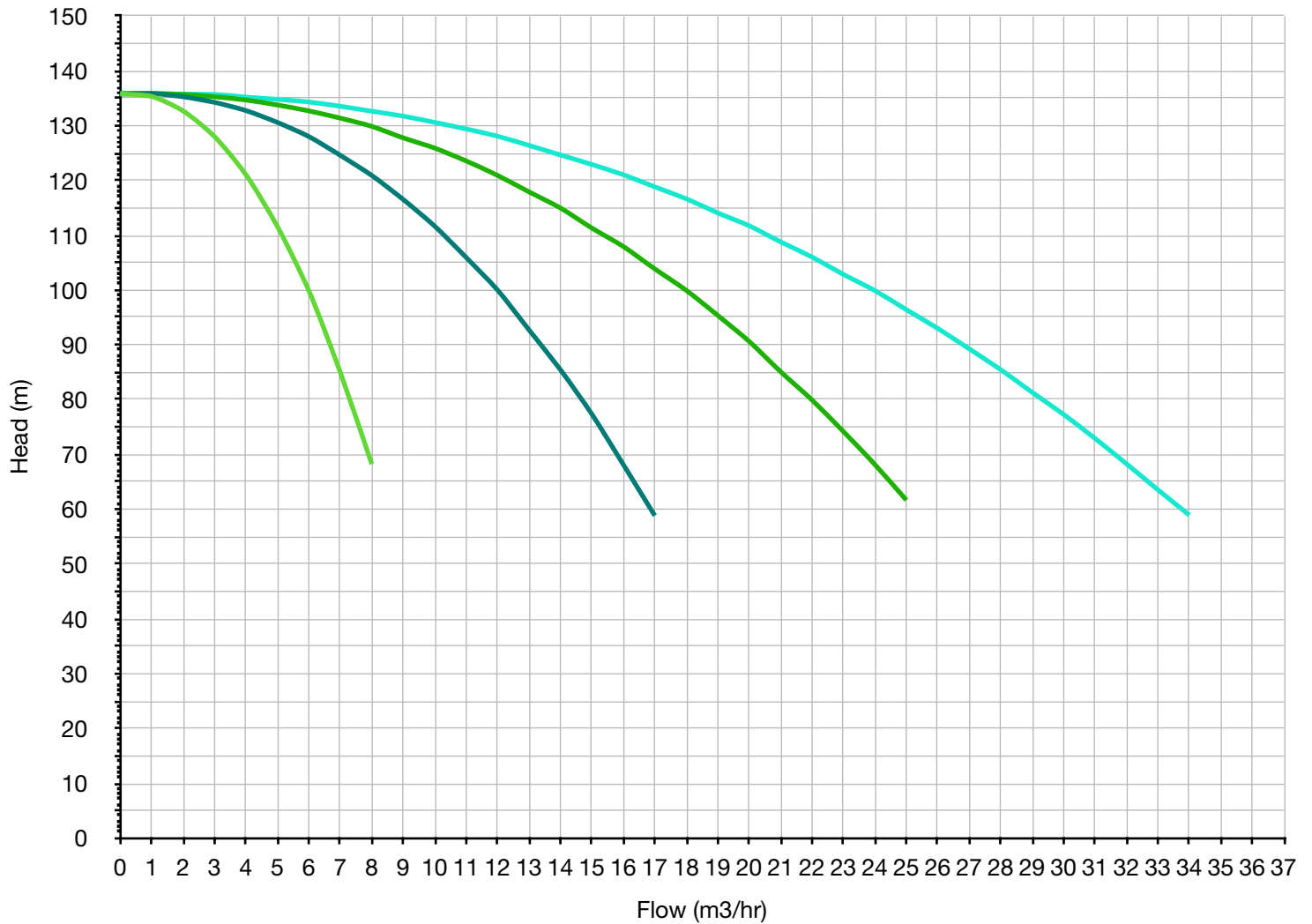

		(5240) 2-PUMP	(5241) 3-PUMP	(5242) 4-PUMP
Performance	Flow (max)	17.0 m ³ /hr	25.5 m ³ /hr	34.0 m ³ /hr
	Head (Q=0)	136m		
	Head (Qmax)	59m		
	Head (Qmin)	126m		
Electrical 400V	Supply	400/3/50		
	Power (kW)	3.0		
	Full Load Current (A)	13.9	20.3	26.8

5SV21

— 1-PUMP — 2-PUMP — 3-PUMP — 4-PUMP

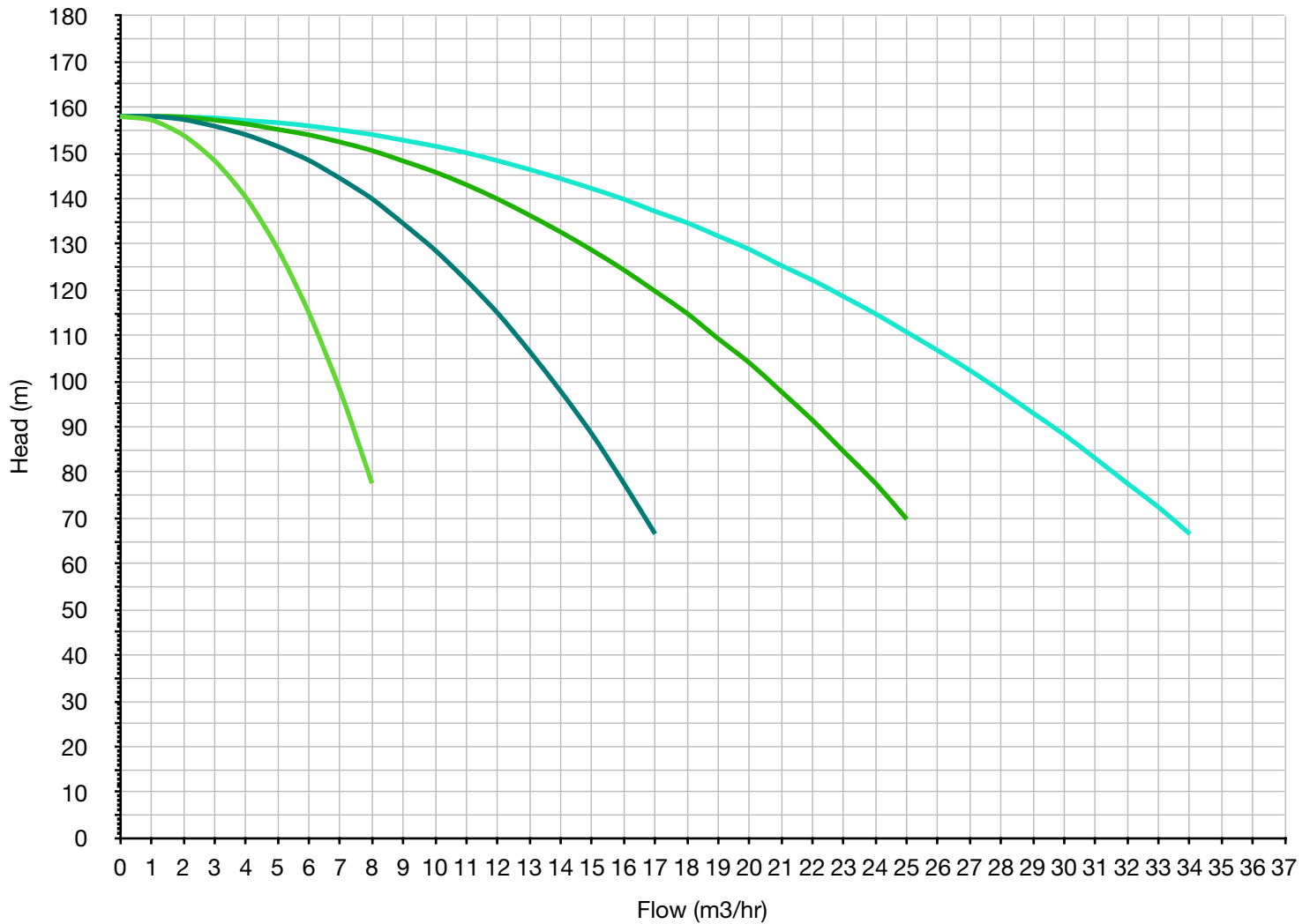

		(5240) 2-PUMP	(5241) 3-PUMP	(5242) 4-PUMP
Performance	Flow (max)	17.0 m ³ /hr	25.5 m ³ /hr	34.0 m ³ /hr
	Head (Q=0)	158m		
	Head (Qmax)	67m		
	Head (Qmin)	148m		
Electrical 400V	Supply	400/3/50		
	Power (kW)	3.0		
	Full Load Current (A)	13.9	20.3	26.8

10SV04

— 1-PUMP — 2-PUMP — 3-PUMP — 4-PUMP

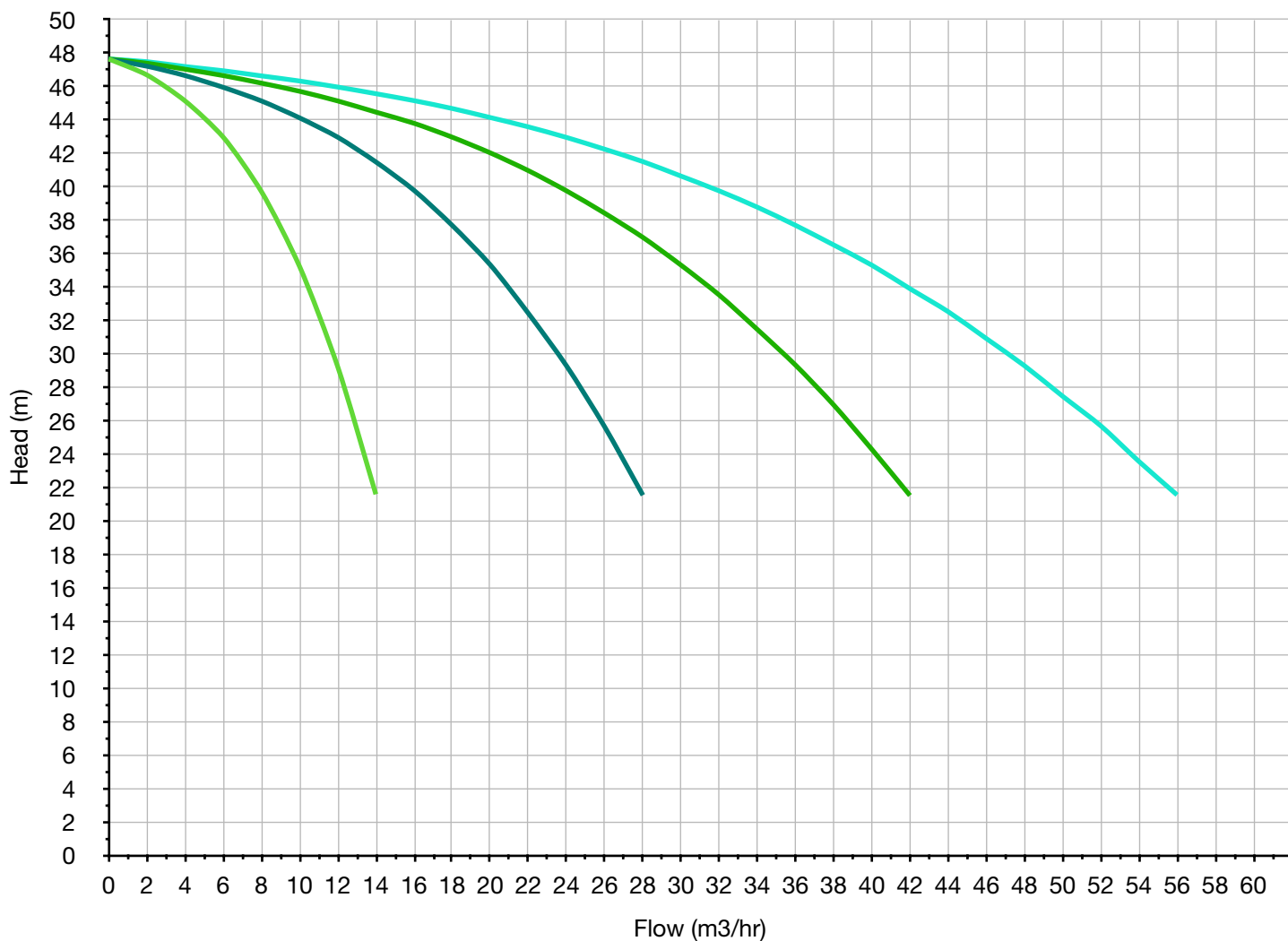

		(5240) 2-PUMP	(5241) 3-PUMP	(5242) 4-PUMP
Performance	Flow (max)	28.0 m³/hr	42.0 m³/hr	56.0 m³/hr
	Head (Q=0)	48m		
	Head (Qmax)	22m		
	Head (Qmin)	38m		
Electrical 230V	Supply	230/1/50		
	Power (kW)	1.5		
	Full Load Current (A)	20.1	29.6	39.2
Electrical 400V	Supply	400/3/50		
	Power (kW)	1.5		
	Full Load Current (A)	7.4	10.5	13.7

10SV05

— 1-PUMP — 2-PUMP — 3-PUMP — 4-PUMP

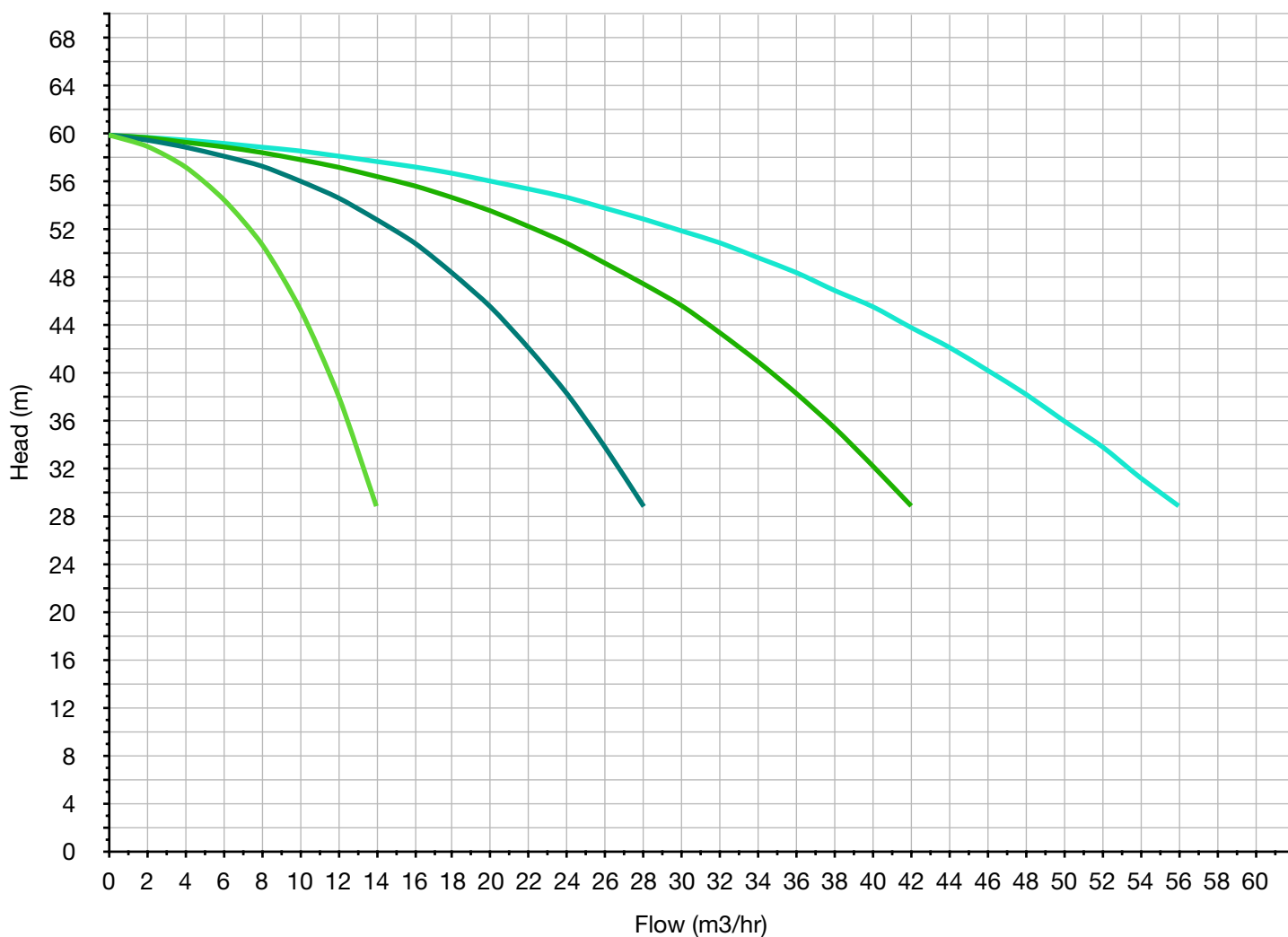

		(5240) 2-PUMP	(5241) 3-PUMP	(5242) 4-PUMP
Performance	Flow (max)	28.0 m ³ /hr	42.0 m ³ /hr	56.0 m ³ /hr
	Head (Q=0)	60m		
	Head (Qmax)	29m		
	Head (Qmin)	50m		
Electrical 230V	Supply	230/1/50		
	Power (kW)	2.2		
	Full Load Current (A)	28.6	42.5	56.3
Electrical 400V	Supply	400/3/50		
	Power (kW)	2.2		
	Full Load Current (A)	10.2	14.8	19.4

10SV06

— 1-PUMP — 2-PUMP — 3-PUMP — 4-PUMP

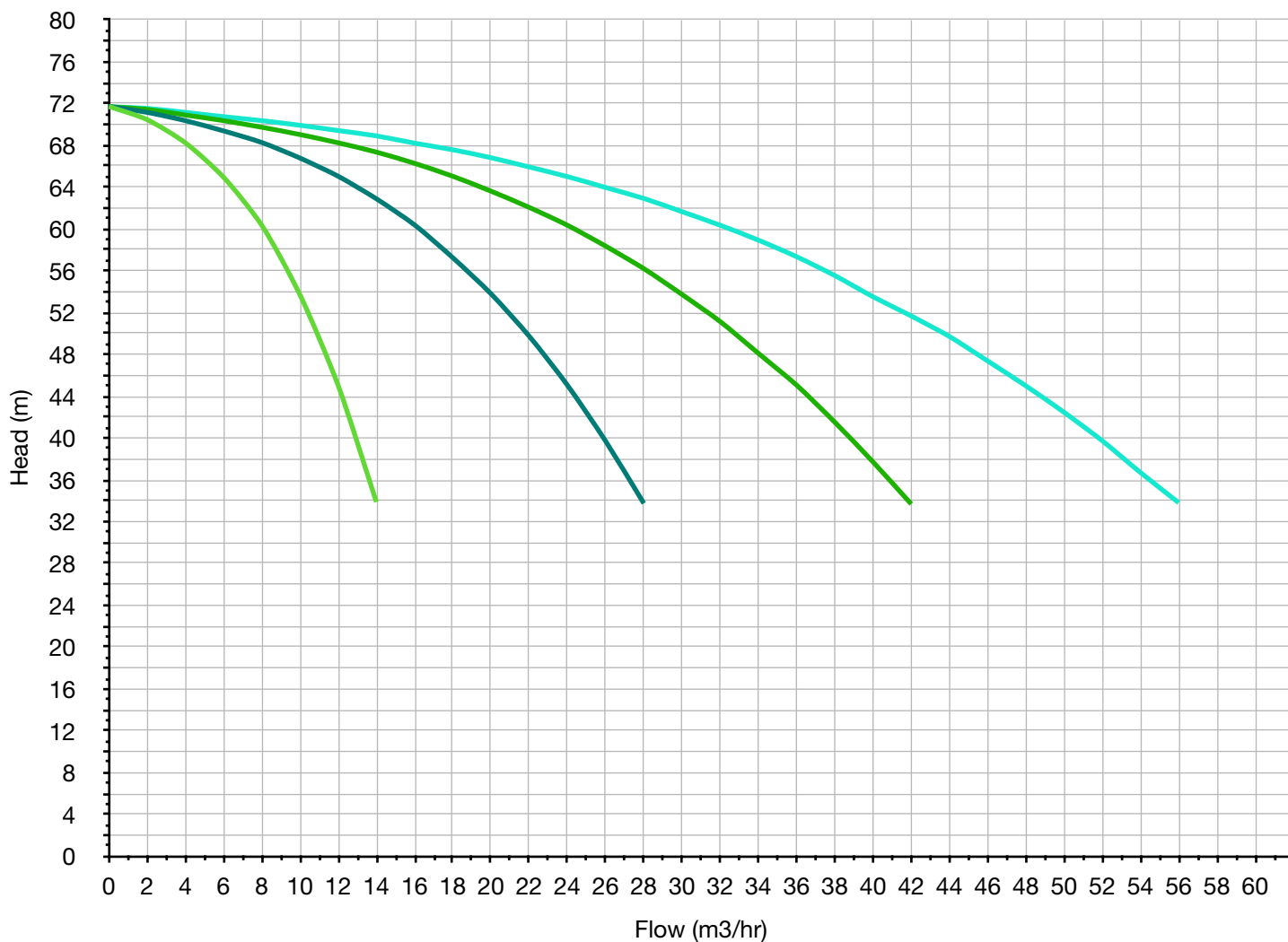

		(5240) 2-PUMP	(5241) 3-PUMP	(5242) 4-PUMP
Performance	Flow (max)	28.0 m ³ /hr	42.0 m ³ /hr	56.0 m ³ /hr
	Head (Q=0)	72m		
	Head (Qmax)	34m		
	Head (Qmin)	62m		
Electrical 230V	Supply	230/1/50		
	Power (kW)	2.2		
	Full Load Current (A)	28.6	42.5	56.3
Electrical 400V	Supply	400/3/50		
	Power (kW)	2.2		
	Full Load Current (A)	10.2	14.8	19.4

10SV07

— 1-PUMP — 2-PUMP — 3-PUMP — 4-PUMP

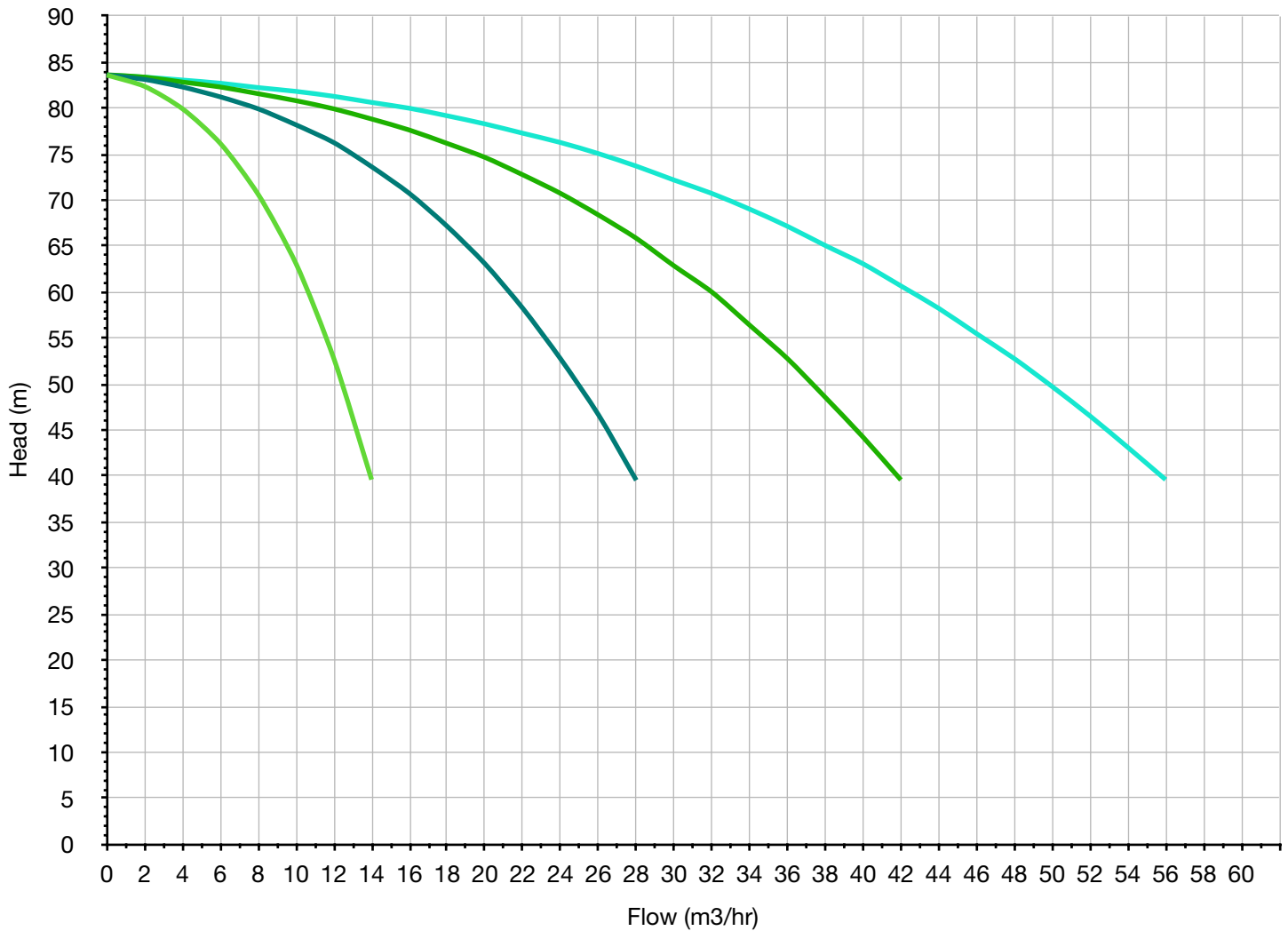

		(5240) 2-PUMP	(5241) 3-PUMP	(5242) 4-PUMP
Performance	Flow (max)	28.0 m ³ /hr	42.0 m ³ /hr	56.0 m ³ /hr
	Head (Q=0)	84m		
	Head (Qmax)	40m		
	Head (Qmin)	74m		
Electrical 400V	Supply	400/3/50		
	Power (kW)	3.0		
	Full Load Current (A)	13.9	20.3	26.8

10SV08

— 1-PUMP — 2-PUMP — 3-PUMP — 4-PUMP

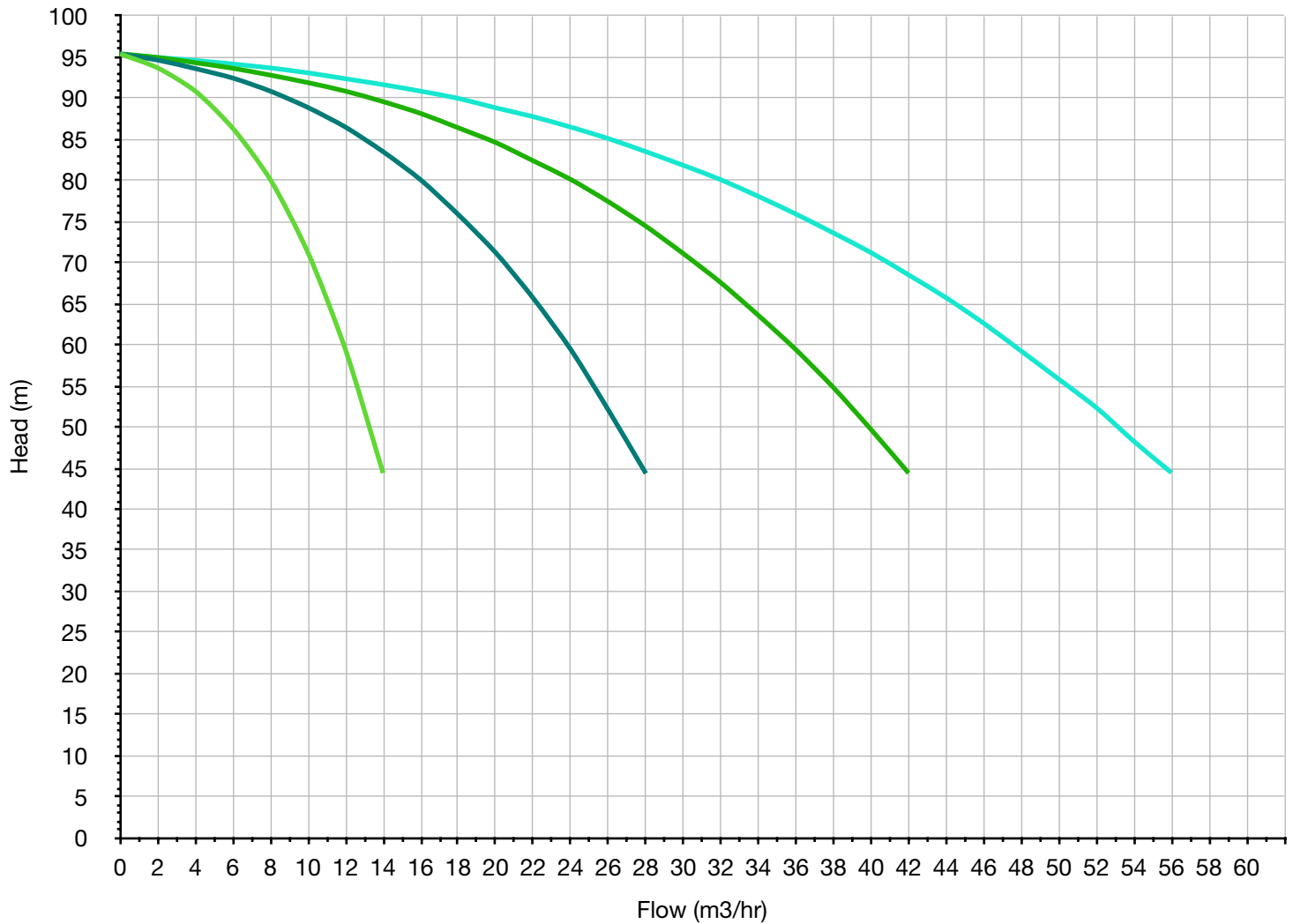

		(5240) 2-PUMP	(5241) 3-PUMP	(5242) 4-PUMP
Performance	Flow (max)	28.0 m ³ /hr	42.0 m ³ /hr	56.0 m ³ /hr
	Head (Q=0)	95m		
	Head (Qmax)	44m		
	Head (Qmin)	85m		
Electrical 400V	Supply	400/3/50		
	Power (kW)	3.0		
	Full Load Current (A)	13.9	20.3	26.8

10SV09

— 1-PUMP — 2-PUMP — 3-PUMP — 4-PUMP

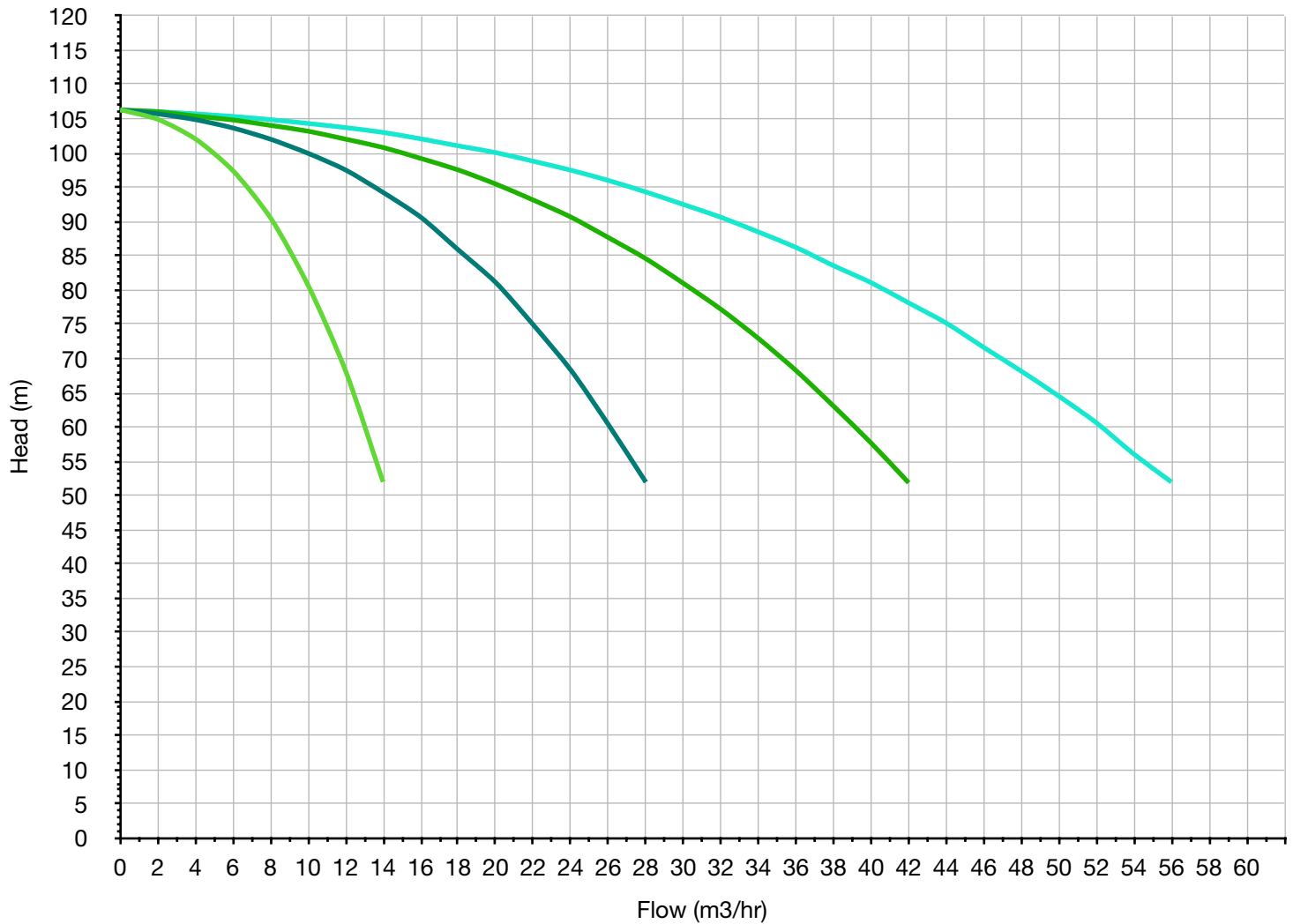

		(5240) 2-PUMP	(5241) 3-PUMP	(5242) 4-PUMP
Performance	Flow (max)	28.0 m ³ /hr	42.0 m ³ /hr	56.0 m ³ /hr
	Head (Q=0)	106m		
	Head (Qmax)	52m		
	Head (Qmin)	96m		
Electrical 400V	Supply	400/3/50		
	Power (kW)	4.0		
	Full Load Current (A)	16.5	24.2	32.0

10SV10

— 1-PUMP — 2-PUMP — 3-PUMP — 4-PUMP

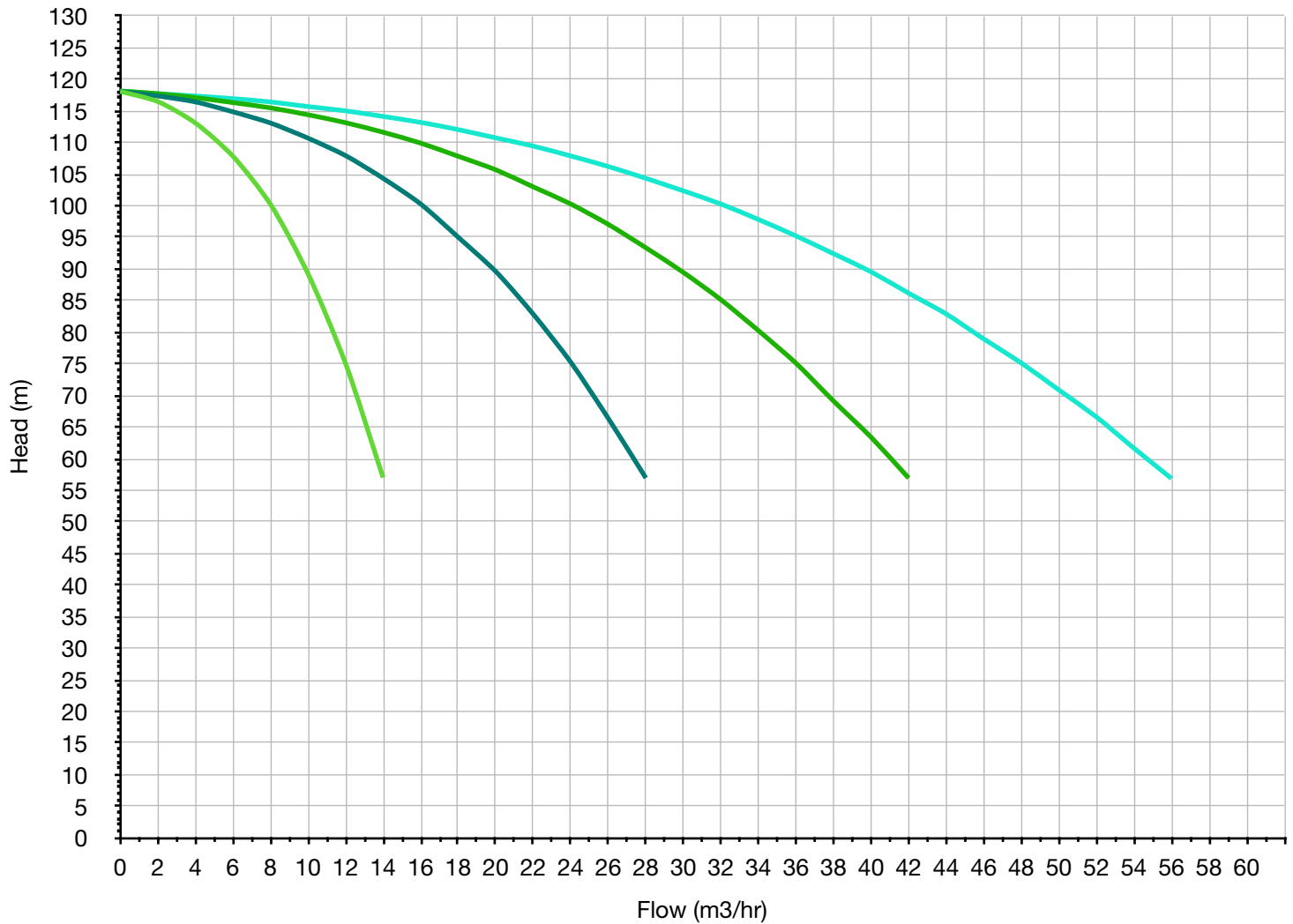

		(5240) 2-PUMP	(5241) 3-PUMP	(5242) 4-PUMP
Performance	Flow (max)	28.0 m ³ /hr	42.0 m ³ /hr	56.0 m ³ /hr
	Head (Q=0)	118m		
	Head (Qmax)	57m		
	Head (Qmin)	108m		
Electrical 400V	Supply	400/3/50		
	Power (kW)	4.0		
	Full Load Current (A)	16.5	24.2	32.0

10SV11

— 1-PUMP — 2-PUMP — 3-PUMP — 4-PUMP

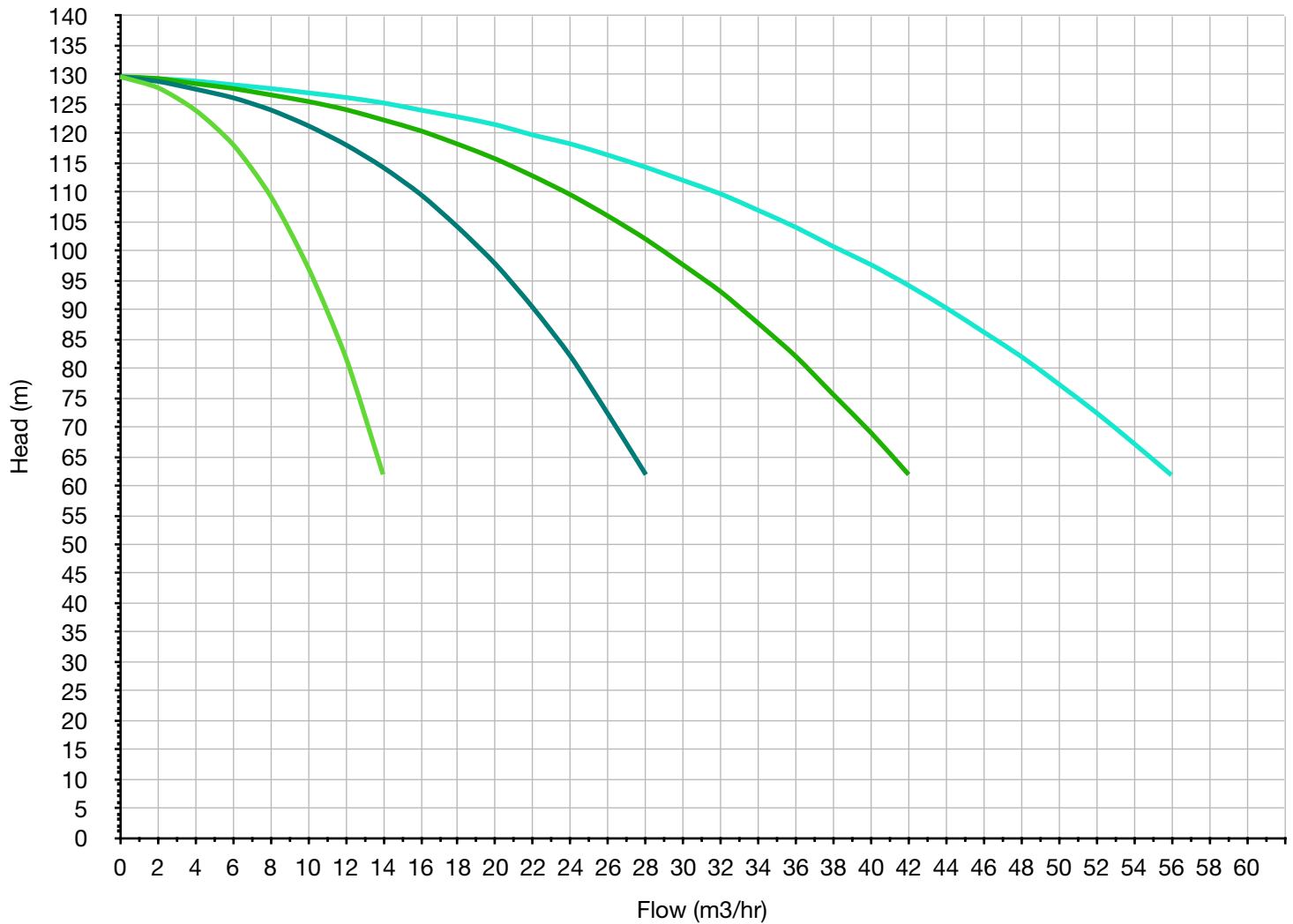

		(5240) 2-PUMP	(5241) 3-PUMP	(5242) 4-PUMP
Performance	Flow (max)	28.0 m ³ /hr	42.0 m ³ /hr	56.0 m ³ /hr
	Head (Q=0)	130m		
	Head (Qmax)	62m		
	Head (Qmin)	120m		
Electrical 400V	Supply	400/3/50		
	Power (kW)	4.0		
	Full Load Current (A)	16.5	24.2	32.0

10SV13

— 1-PUMP — 2-PUMP — 3-PUMP — 4-PUMP

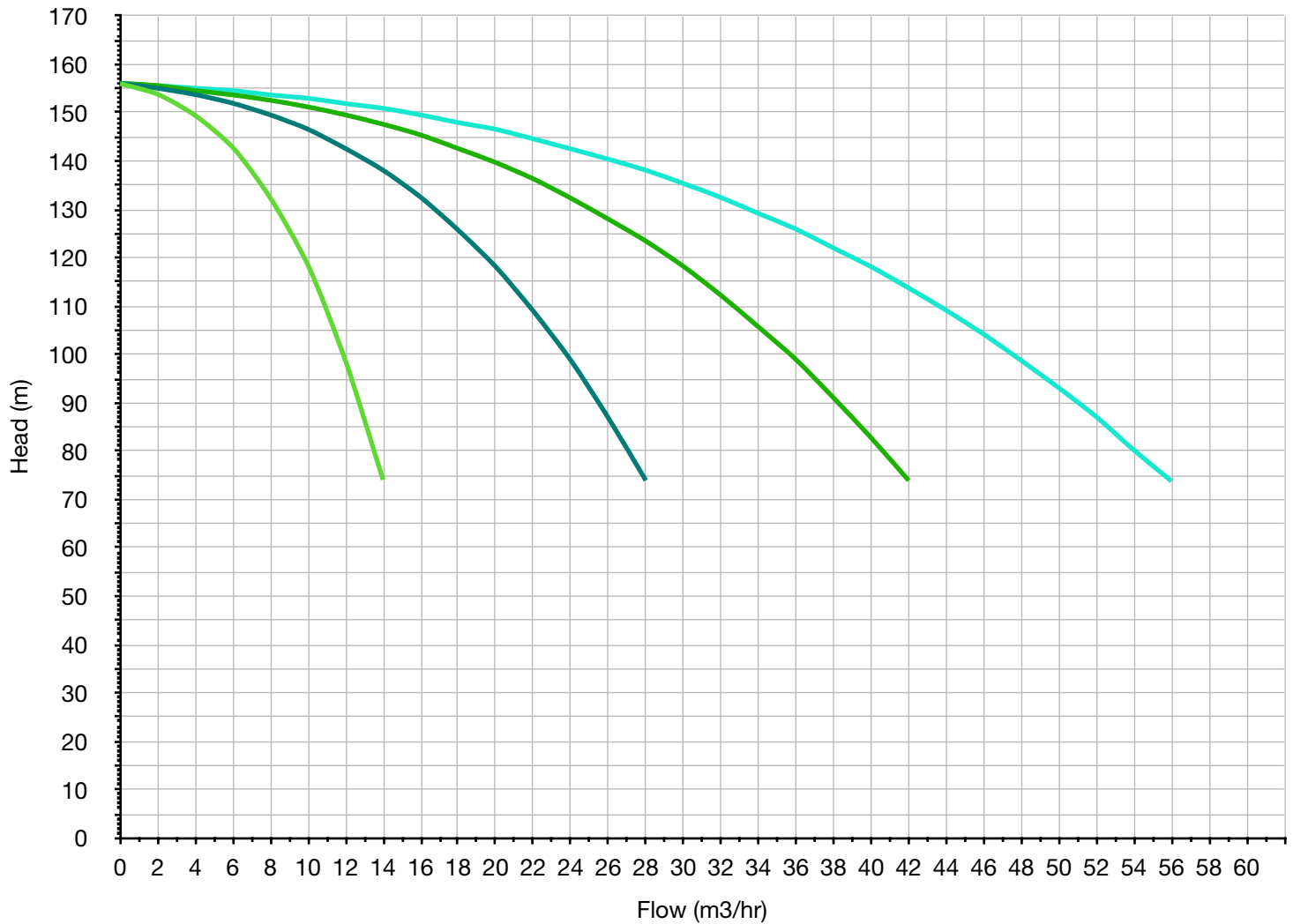

		(5240) 2-PUMP	(5241) 3-PUMP	(5242) 4-PUMP
Performance	Flow (max)	28.0 m ³ /hr	42.0 m ³ /hr	56.0 m ³ /hr
	Head (Q=0)	156m		
	Head (Qmax)	74m		
	Head (Qmin)	146m		
Electrical 400V	Supply	400/3/50		
	Power (kW)	5.5		
	Full Load Current (A)	21.8	32.2	42.6

15SV03

— 1-PUMP — 2-PUMP — 3-PUMP — 4-PUMP

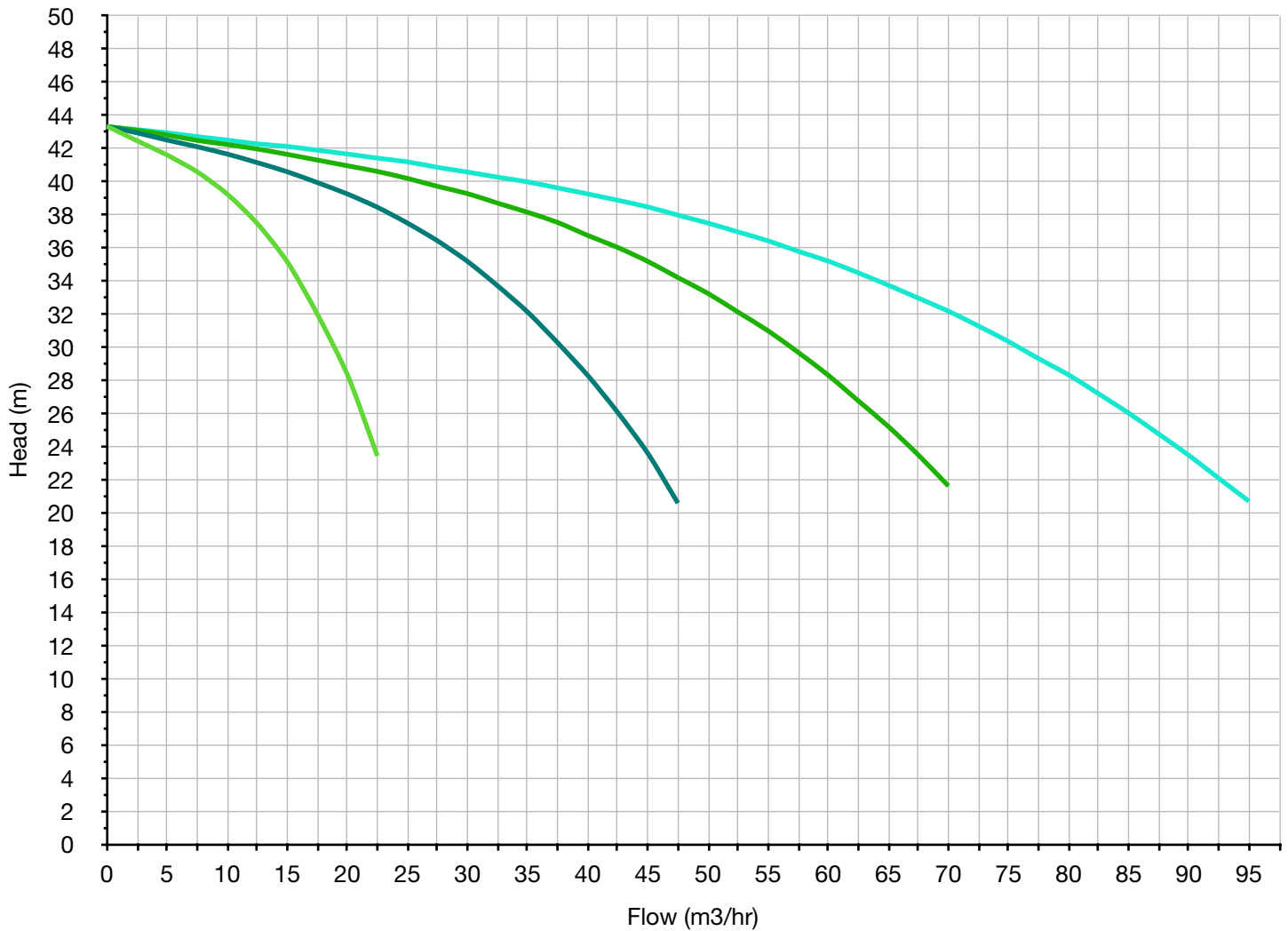

		(5240) 2-PUMP	(5241) 3-PUMP	(5242) 4-PUMP
Performance	Flow (max)	48.0 m³/hr	72.0 m³/hr	96.0 m³/hr
	Head (Q=0)	43m		
	Head (Qmax)	20m		
	Head (Qmin)	33m		
Electrical 400V	Supply	400/3/50		
	Power (kW)	3.0		
	Full Load Current (A)	6.4	20.3	26.8

15SV04

— 1-PUMP — 2-PUMP — 3-PUMP — 4-PUMP

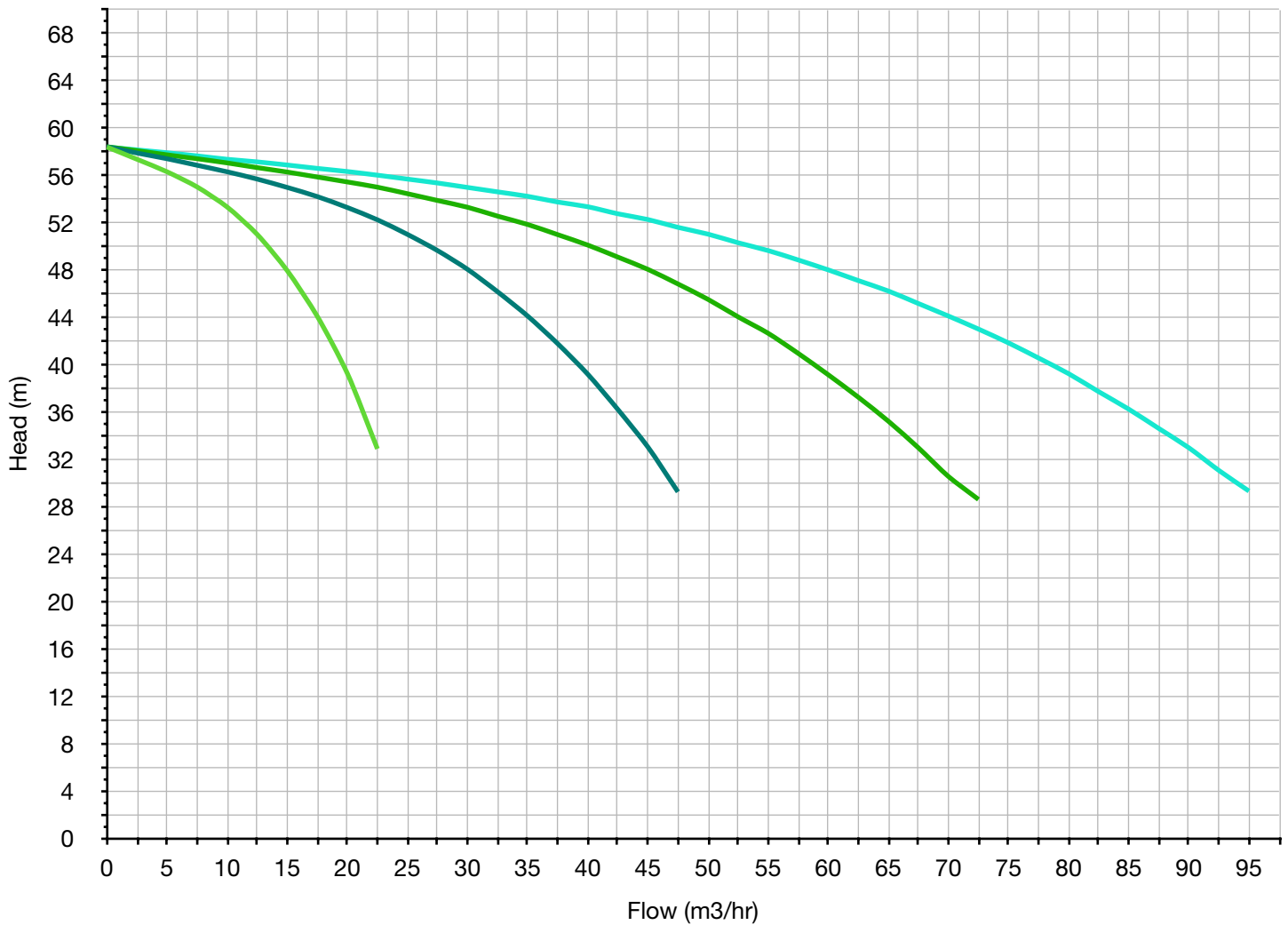

		(5240) 2-PUMP	(5241) 3-PUMP	(5242) 4-PUMP
Performance	Flow (max)	48.0 m ³ /hr	72.0 m ³ /hr	96.0 m ³ /hr
	Head (Q=0)	58m		
	Head (Qmax)	29m		
	Head (Qmin)	48m		
Electrical 400V	Supply	400/3/50		
	Power (kW)	4.0		
	Full Load Current (A)	16.5	24.2	32.0

15SV05

— 1-PUMP — 2-PUMP — 3-PUMP — 4-PUMP

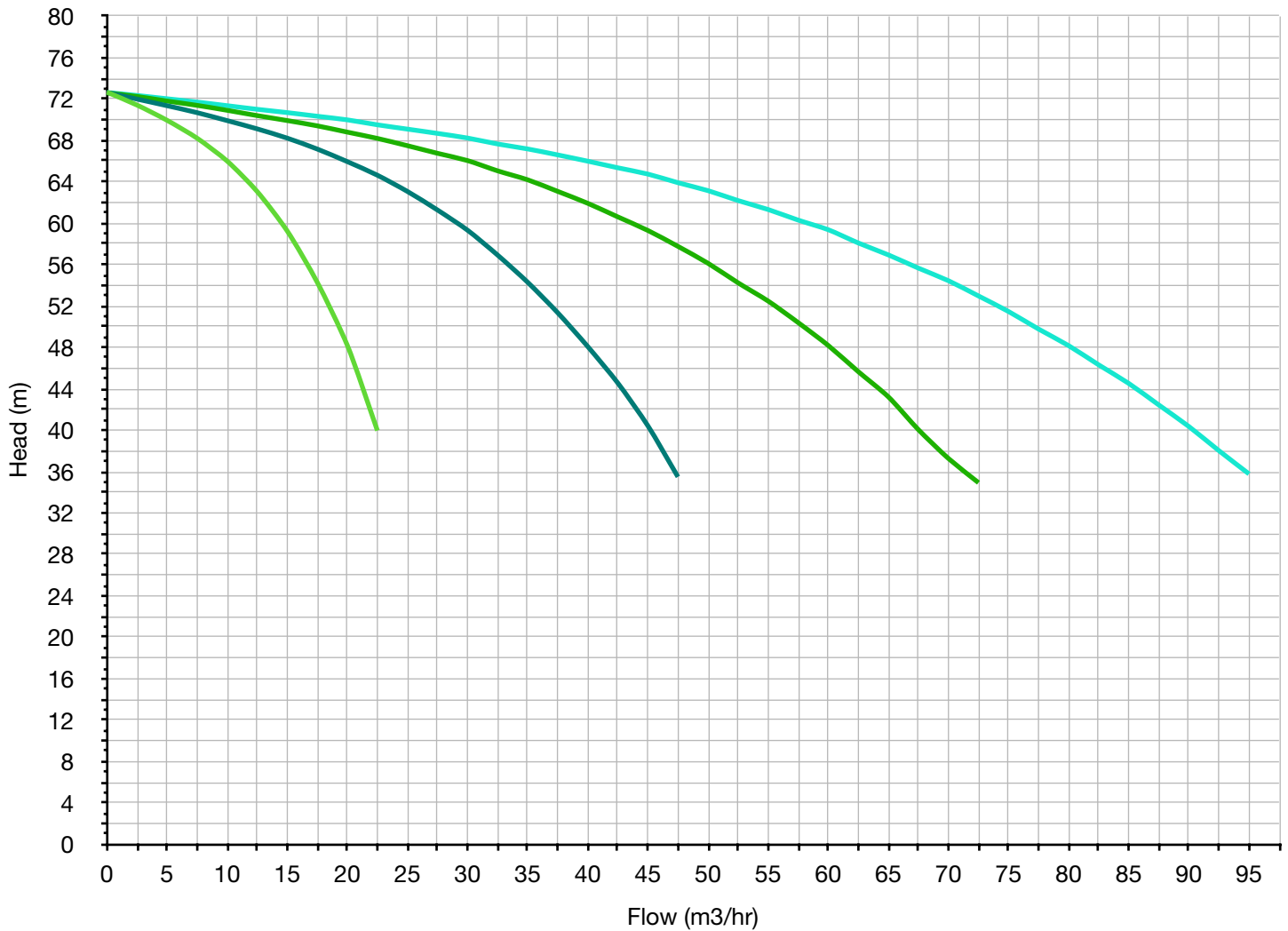

		(5240) 2-PUMP	(5241) 3-PUMP	(5242) 4-PUMP
Performance	Flow (max)	48.0 m ³ /hr	72.0 m ³ /hr	96.0 m ³ /hr
	Head (Q=0)	73m		
	Head (Qmax)	35m		
	Head (Qmin)	63m		
Electrical 400V	Supply	400/3/50		
	Power (kW)	4.0		
	Full Load Current (A)	16.5	24.2	32.0

15SV06

— 1-PUMP — 2-PUMP — 3-PUMP — 4-PUMP

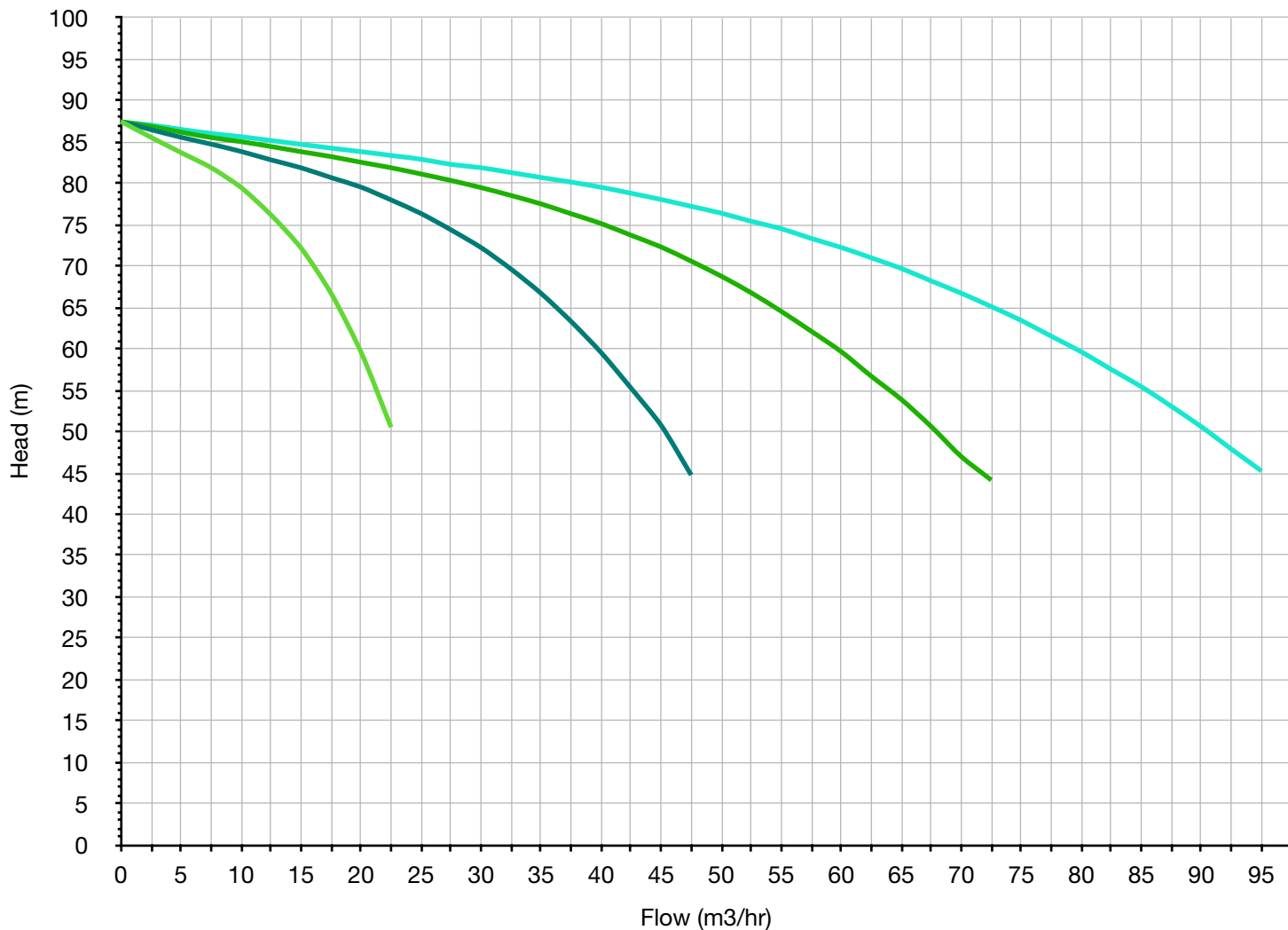

		(5240) 2-PUMP	(5241) 3-PUMP	(5242) 4-PUMP
Performance	Flow (max)	48.0 m ³ /hr	72.0 m ³ /hr	96.0 m ³ /hr
	Head (Q=0)	88m		
	Head (Qmax)	44m		
	Head (Qmin)	78m		
Electrical 400V	Supply	400/3/50		
	Power (kW)	5.5		
	Full Load Current (A)	21.8	32.2	42.6

15SV07

— 1-PUMP — 2-PUMP — 3-PUMP — 4-PUMP

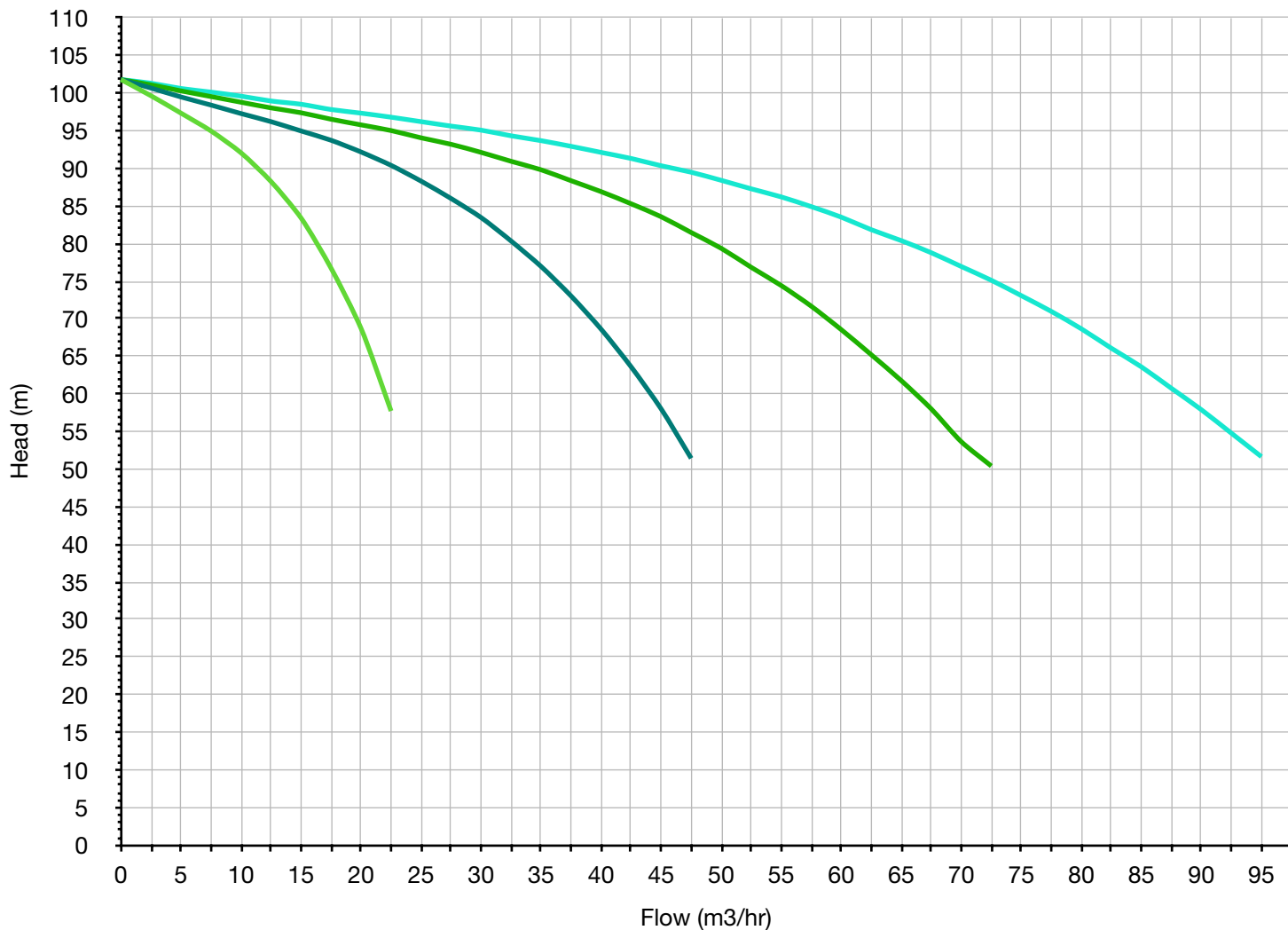

		(5240) 2-PUMP	(5241) 3-PUMP	(5242) 4-PUMP
Performance	Flow (max)	48.0 m ³ /hr	72.0 m ³ /hr	96.0 m ³ /hr
	Head (Q=0)	102m		
	Head (Qmax)	51m		
	Head (Qmin)	92m		
Electrical 400V	Supply	400/3/50		
	Power (kW)	5.5		
	Full Load Current (A)	21.8	32.2	42.6

15SV08

— 1-PUMP — 2-PUMP — 3-PUMP — 4-PUMP

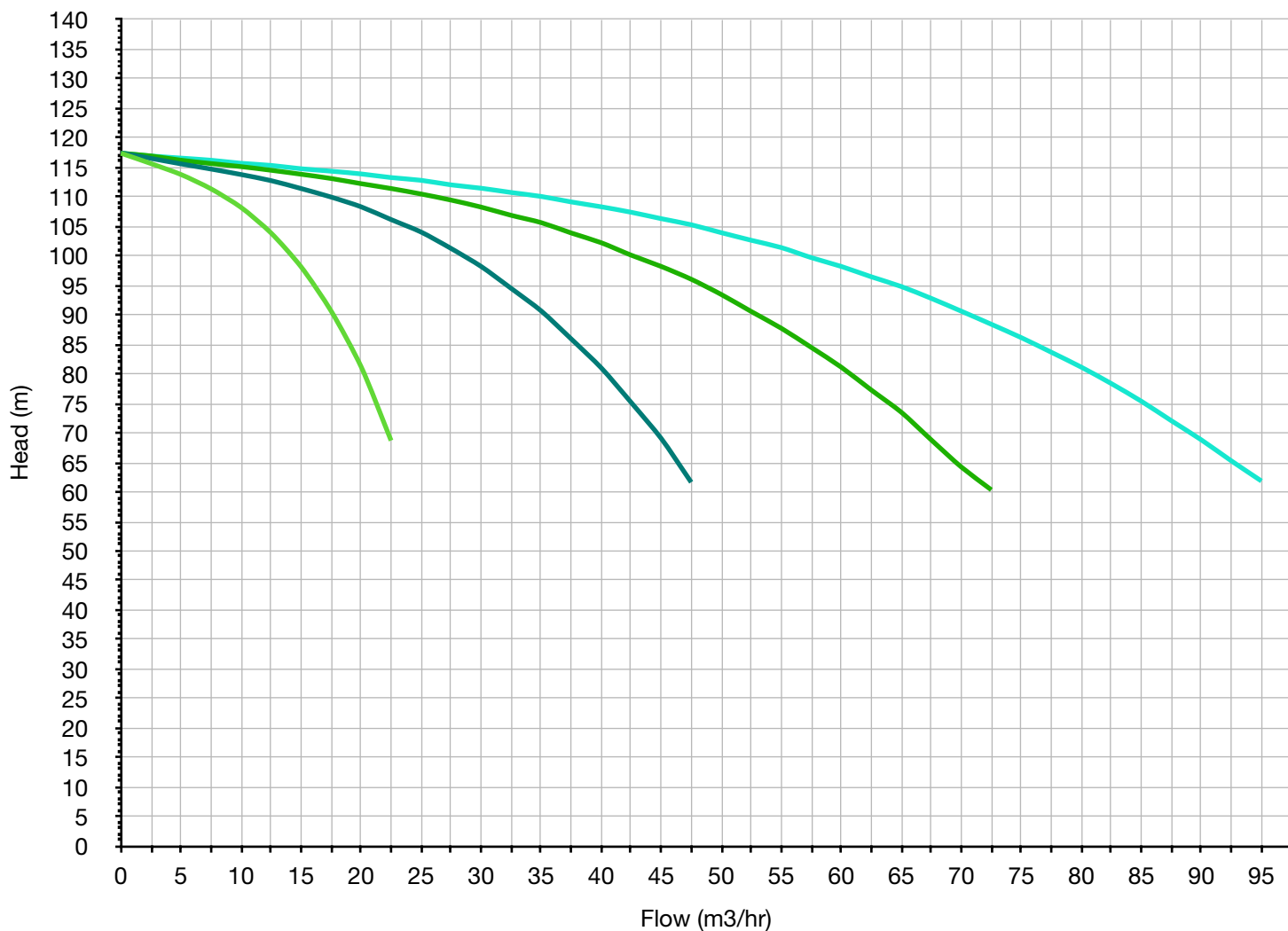

		(5240) 2-PUMP	(5241) 3-PUMP	(5242) 4-PUMP
Performance	Flow (max)	48.0 m ³ /hr	72.0 m ³ /hr	96.0 m ³ /hr
	Head (Q=0)	117m		
	Head (Qmax)	61m		
	Head (Qmin)	107m		
Electrical 400V	Supply	400/3/50		
	Power (kW)	7.5		
	Full Load Current (A)	29.0	43.0	57.0

15SV09

— 1-PUMP — 2-PUMP — 3-PUMP — 4-PUMP

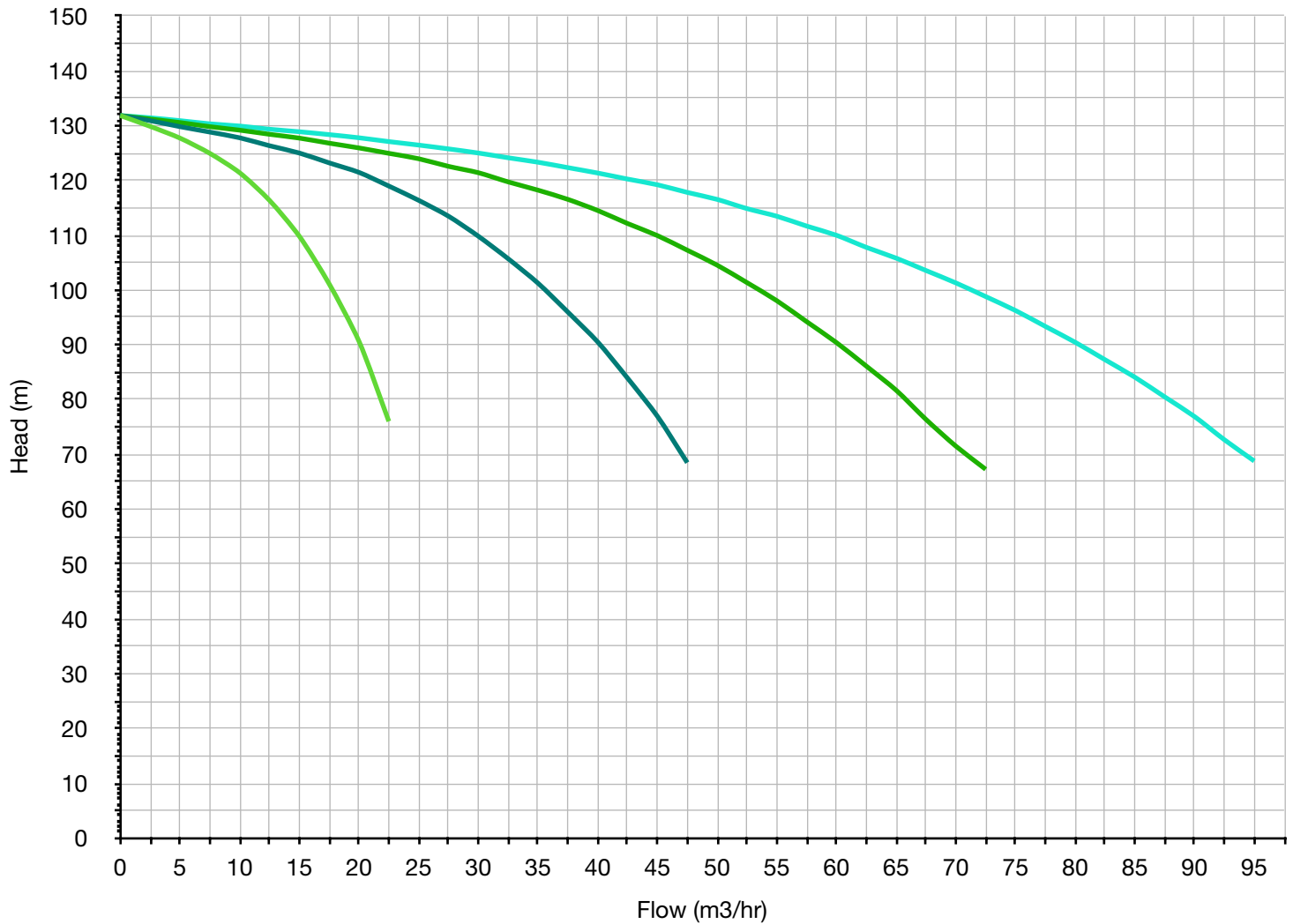

		(5240) 2-PUMP	(5241) 3-PUMP	(5242) 4-PUMP
Performance	Flow (max)	48.0 m ³ /hr	72.0 m ³ /hr	96.0 m ³ /hr
	Head (Q=0)	132m		
	Head (Qmax)	67m		
	Head (Qmin)	122m		
Electrical 400V	Supply	400/3/50		
	Power (kW)	7.5		
	Full Load Current (A)	29.0	43.0	57.0

22SV03

— 1-PUMP — 2-PUMP — 3-PUMP — 4-PUMP

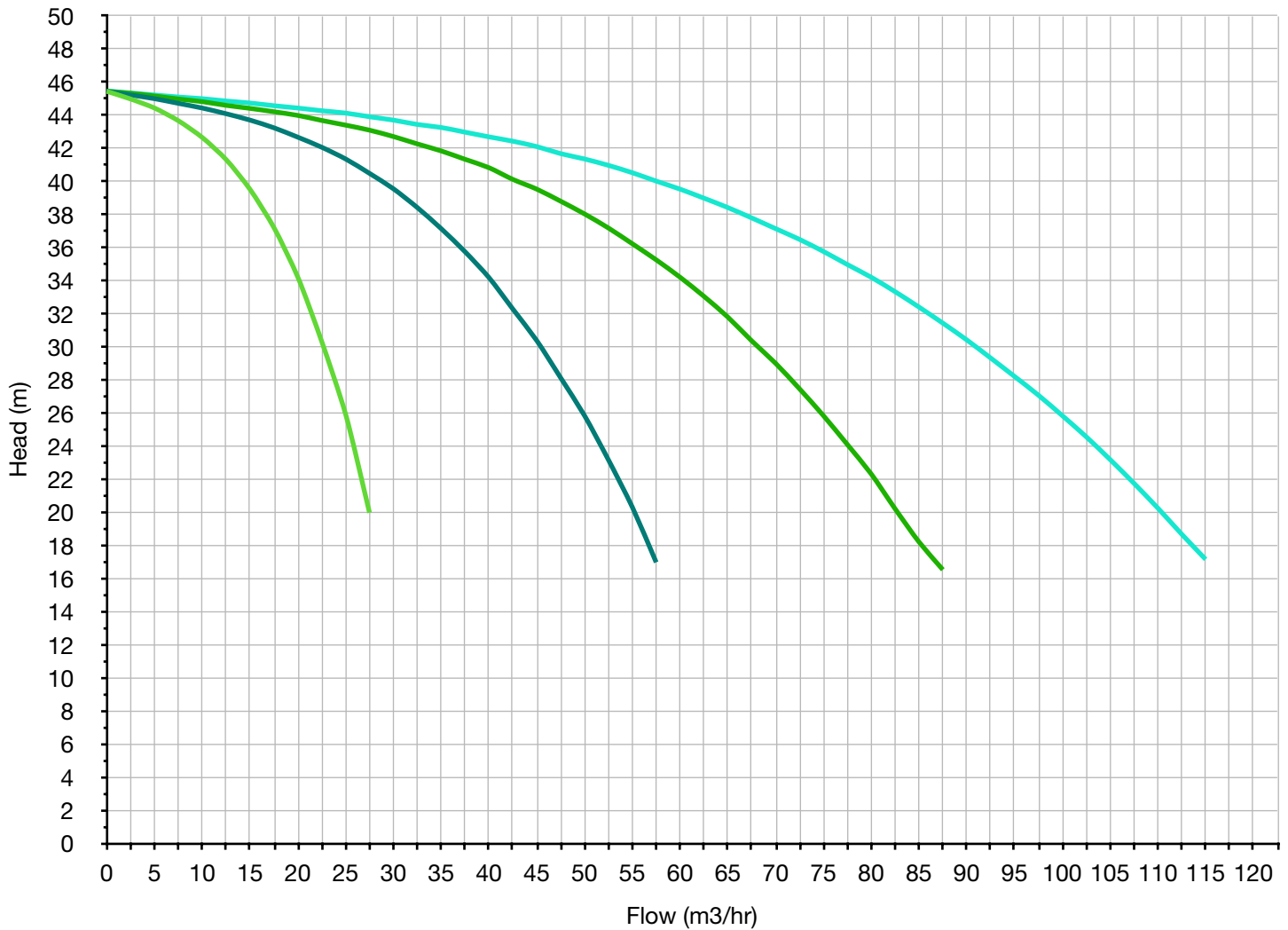

		(5240) 2-PUMP	(5241) 3-PUMP	(5242) 4-PUMP
Performance	Flow (max)	58.0 m ³ /hr	87.0 m ³ /hr	116.0 m ³ /hr
	Head (Q=0)	45m		
	Head (Qmax)	17m		
	Head (Qmin)	35m		
Electrical 400V	Supply	400/3/50		
	Power (kW)	3.0		
	Full Load Current (A)	13.9	20.3	26.8

22SV04

— 1-PUMP — 2-PUMP — 3-PUMP — 4-PUMP

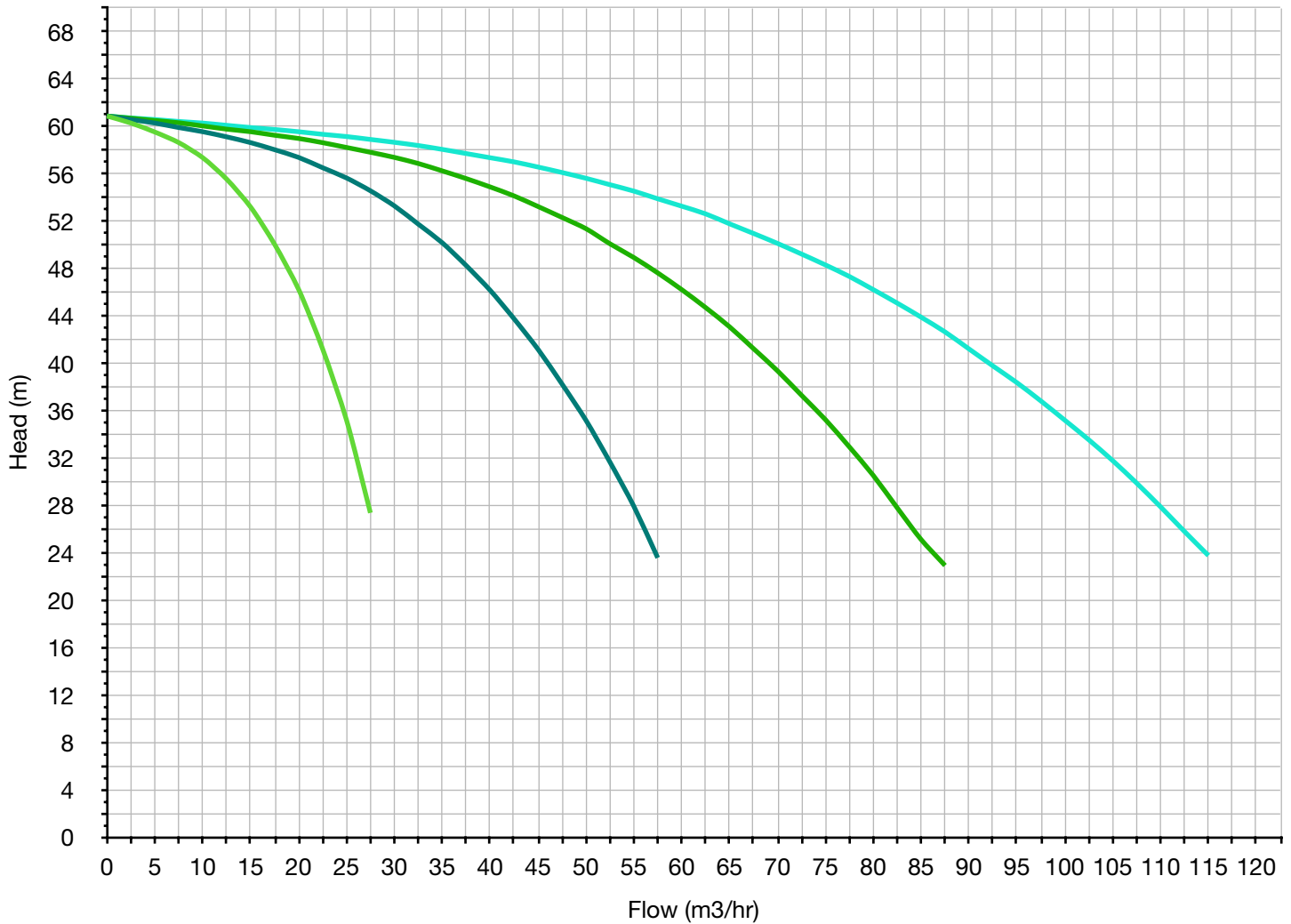

		(5240) 2-PUMP	(5241) 3-PUMP	(5242) 4-PUMP
Performance	Flow (max)	58.0 m ³ /hr	87.0 m ³ /hr	116.0 m ³ /hr
	Head (Q=0)	61m		
	Head (Qmax)	23m		
	Head (Qmin)	51m		
Electrical 400V	Supply	400/3/50		
	Power (kW)	4.0		
	Full Load Current (A)	16.5	24.2	32.0

22SV05

— 1-PUMP — 2-PUMP — 3-PUMP — 4-PUMP

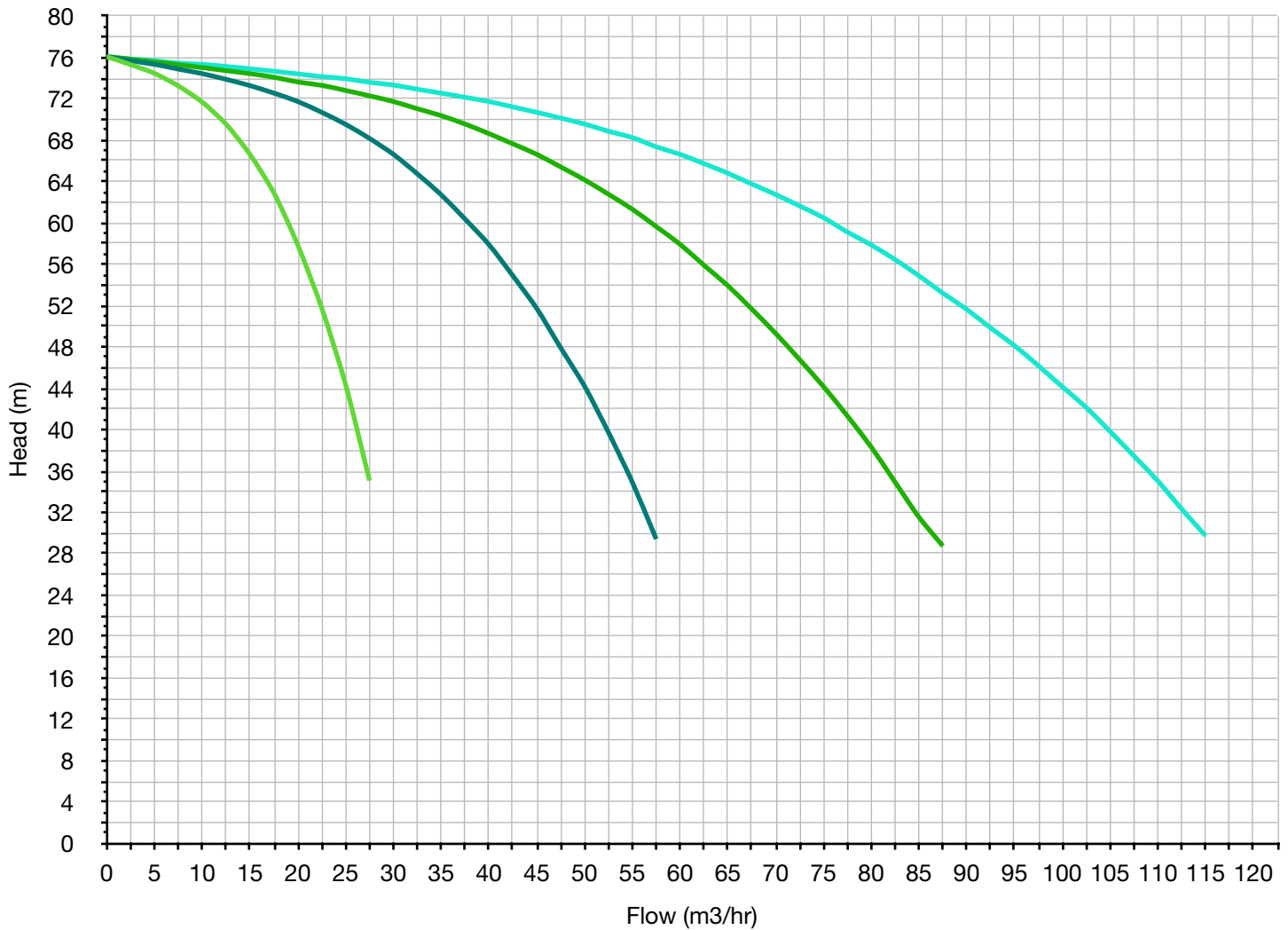

		(5240) 2-PUMP	(5241) 3-PUMP	(5242) 4-PUMP
Performance	Flow (max)	58.0 m ³ /hr	87.0 m ³ /hr	116.0 m ³ /hr
	Head (Q=0)	76m		
	Head (Qmax)	29m		
	Head (Qmin)	66m		
Electrical 400V	Supply	400/3/50		
	Power (kW)	5.5		
	Full Load Current (A)	21.8	32.2	42.6

22SV06

— 1-PUMP — 2-PUMP — 3-PUMP — 4-PUMP

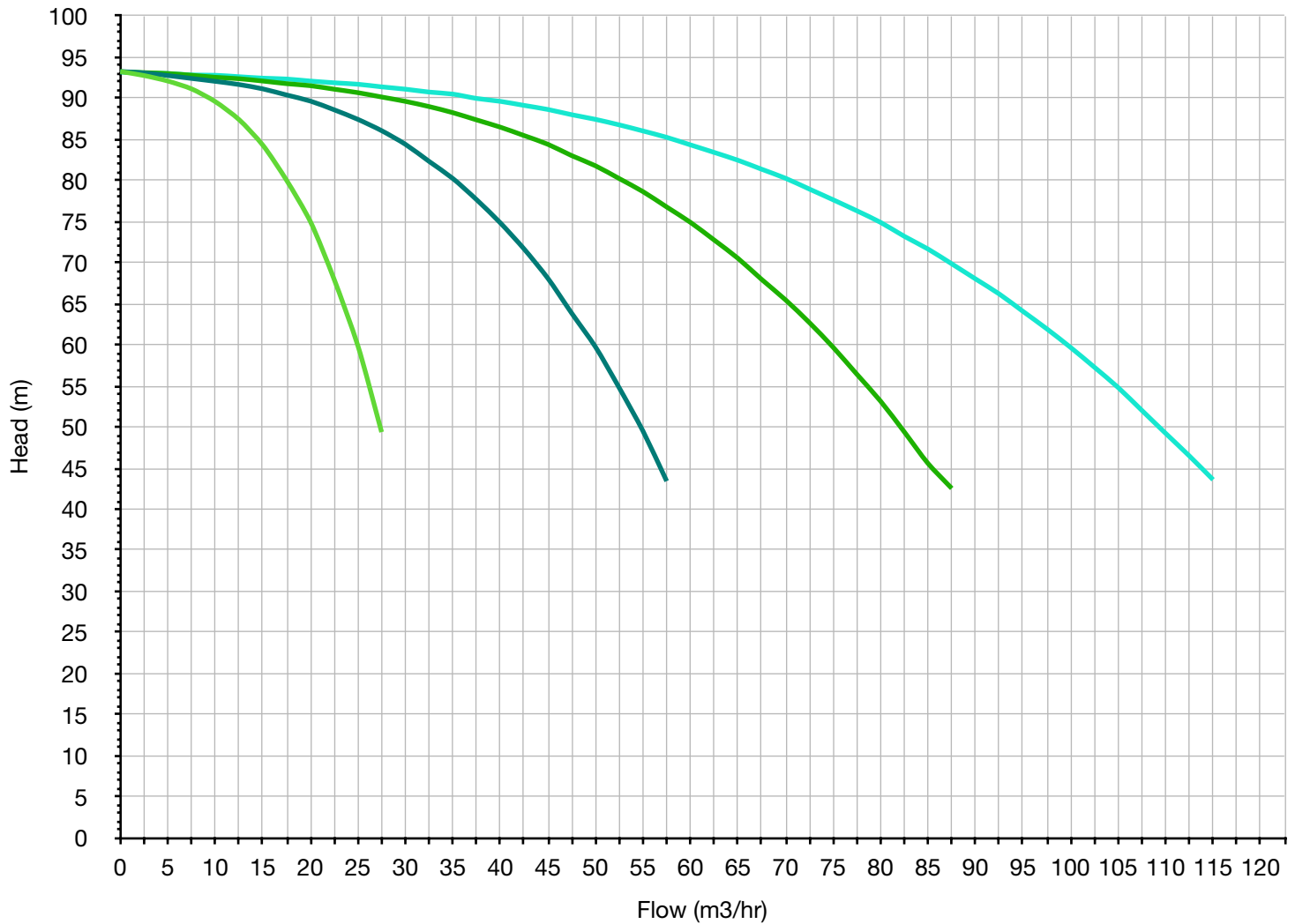

		(5240) 2-PUMP	(5241) 3-PUMP	(5242) 4-PUMP
Performance	Flow (max)	58.0 m ³ /hr	87.0 m ³ /hr	116.0 m ³ /hr
	Head (Q=0)	93m		
	Head (Qmax)	43m		
	Head (Qmin)	83m		
Electrical 400V	Supply	400/3/50		
	Power (kW)	7.5		
	Full Load Current (A)	29	43	57

22SV07

— 1-PUMP — 2-PUMP — 3-PUMP — 4-PUMP

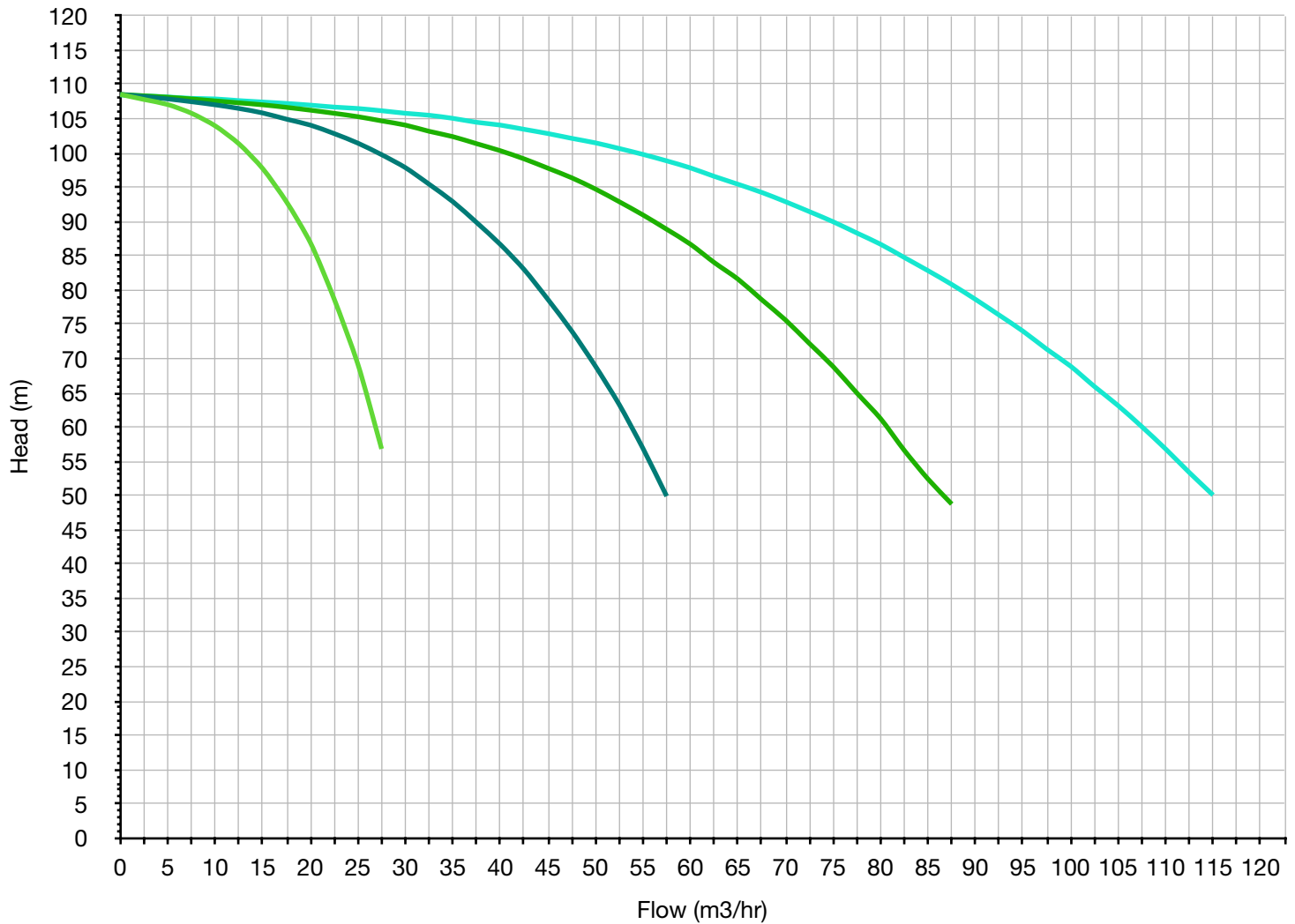

		(5240) 2-PUMP	(5241) 3-PUMP	(5242) 4-PUMP
Performance	Flow (max)	58.0 m ³ /hr	87.0 m ³ /hr	116.0 m ³ /hr
	Head (Q=0)	108m		
	Head (Qmax)	49m		
	Head (Qmin)	98m		
Electrical 400V	Supply	400/3/50		
	Power (kW)	7.5		
	Full Load Current (A)	29	43	57

5240 Series

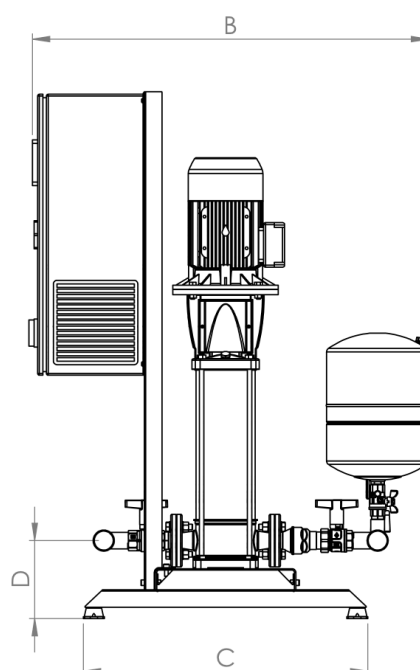
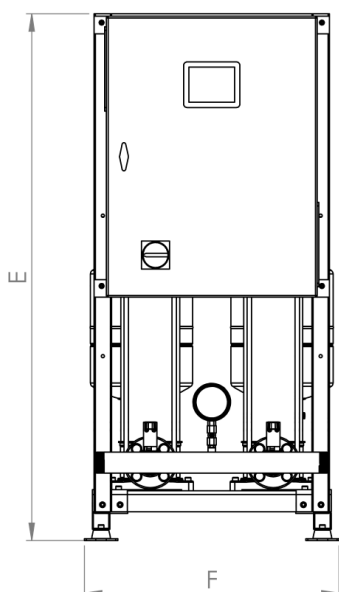
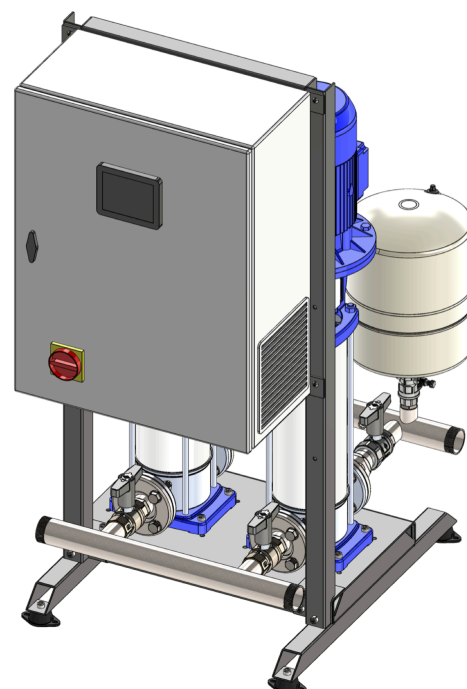
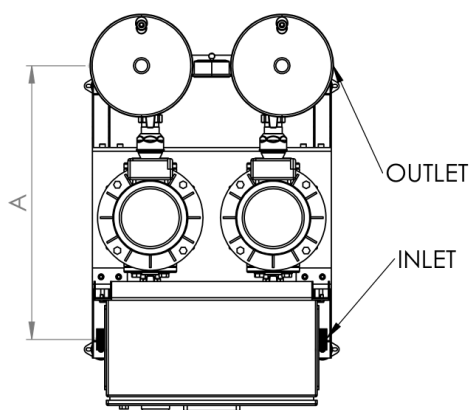

Model	Inlet	Outlet	A	B	C	D	E	F
3SV	1-1/4" Male BSP		630	1050	810	217	1500	725
5SV	1-1/2" Male BSP		675	1070		222		
10SV	2" Male BSP		780	1130		232		
15SV	DN80 PN16		880	1190				
22SV								

5241 Series

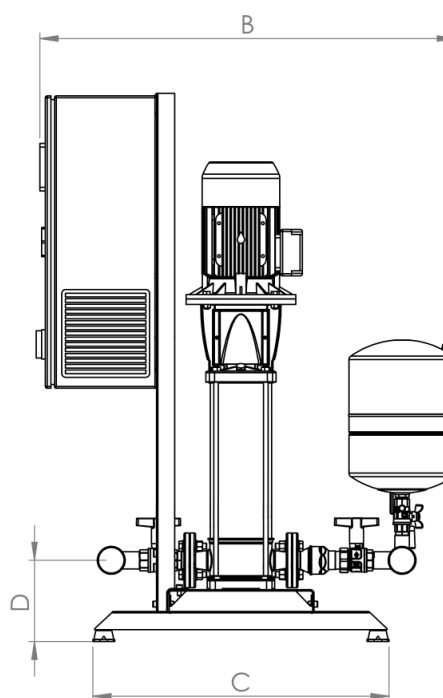
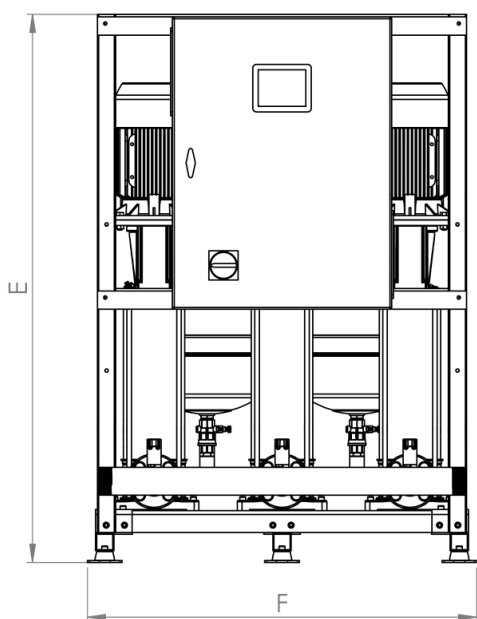
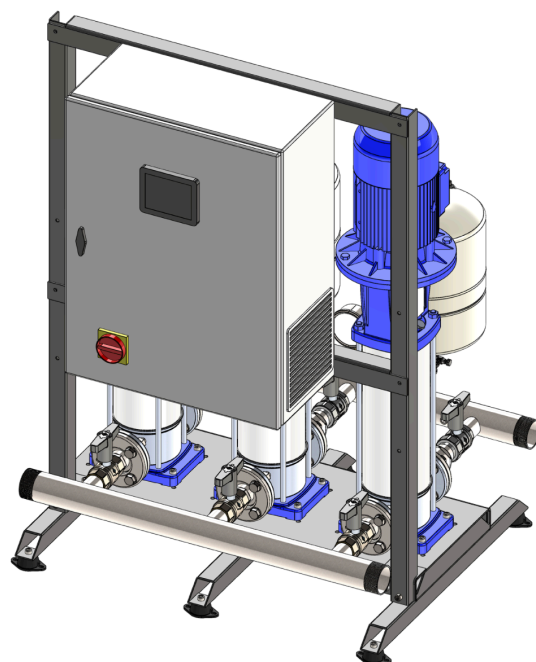
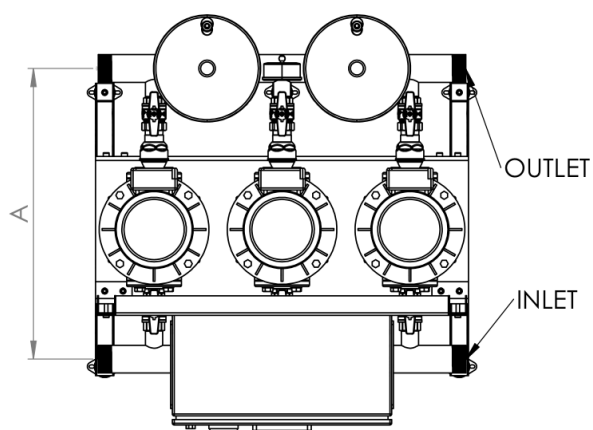

Model	Inlet	Outlet	A	B	C	D	E	F
3SV	1-1/2" Male BSP		640	1050	810	217	1500	1065
5SV	2" Male BSP		685	1070		222		
10SV	DN65 PN16		795	1135		232		
15SV	DN80 PN16		880	1190				
22SV								

5242 Series

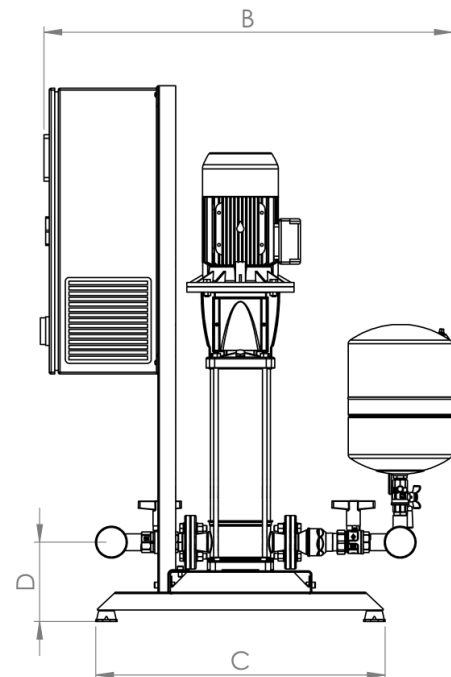
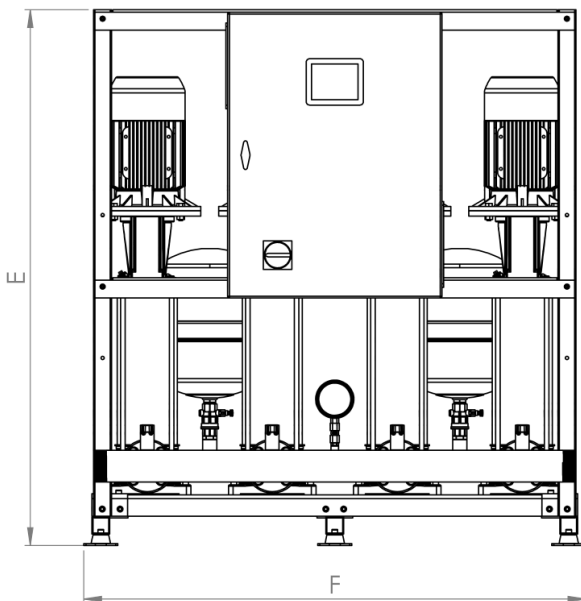
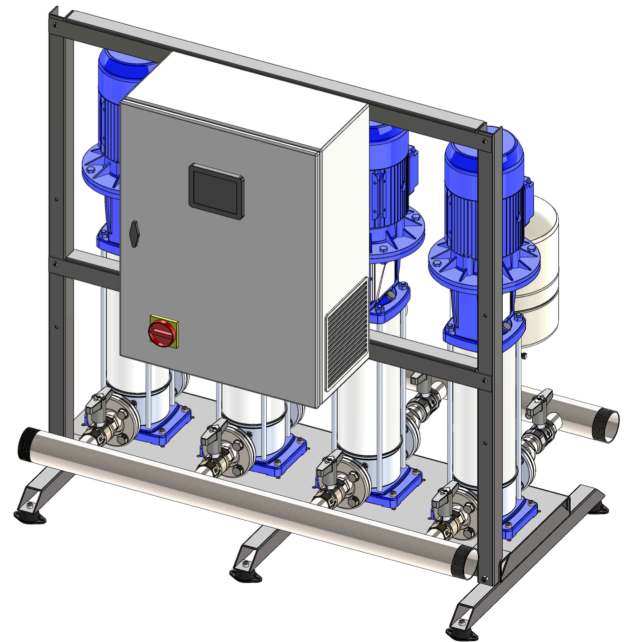
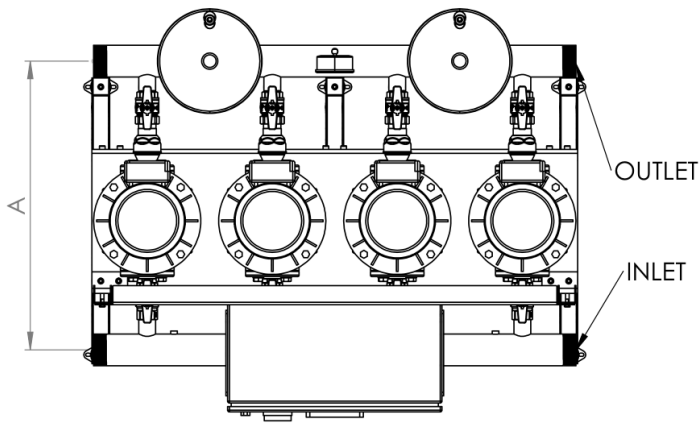

Model	Inlet	Outlet	A	B	C	D	E	F	
3SV	2" Male BSP		650	1060	810	217	1500	1405	
5SV	DN65 PN16		700	1080					
10SV	DN80 PN16		810	1150		222			
15SV	DN100 PN16		910	1190					232
22SV									

Model	Weight (Kg)		
	5240	5241	5242
3SV04	116	150	175
3SV06	122	158	186
3SV08	131	172	204
3SV10	136	180	215
3SV12	139	183	220
3SV14	144	192	231
3SV16	146	194	234
3SV19	158	212	258
3SV21	160	215	262
5SV Series			
5SV04	124	165	194
5SV06	136	184	219
5SV08	138	187	223
5SV10	144	196	235
5SV12	156	213	258
5SV14	158	216	262
5SV16	160	219	266
5SV18	169	234	285
5SV21	172	238	291
10SV Series			
10SV04	161	216	268
10SV05	172	233	291
10SV06	175	237	295
10SV07	184	250	314
10SV08	186	253	317
10SV09	198	272	343
10SV10	200	275	347
10SV11	203	279	352
10SV13	241	336	428

Model	Weight (Kg)		
	5240	5241	5242
15SV03	187	251	319
15SV04	201	272	346
15SV05	203	275	350
15SV06	241	332	427
15SV07	243	335	431
15SV08	283	395	511
15SV09	287	401	519
22SV03	188	252	320
22SV04	201	273	347
22SV05	237	326	419
22SV06	275	383	495
22SV07	279	389	503

PRESSURE & HEAD

Newton per square metre (N/m ²) (Pa)	Kilo Pascal (kPa)	Bar	Pound Per Square Inch (PSI)	Metre of Water (m H ₂ O)
1	0.001	0.00001	14,500	0.000104
1,000	1	0.01	0.145	0.102
100,000	100	1	14.5	10.197
6,894	6.89	0.689	1	0.703
9,806	9.806	0.981	1.433	1

VOLUMETRIC FLOW

Litres Per Minute (L/min)	Cubic Metres Per Hour (m ³ /hr)	Cubic Feet Per Hour (ft ³ /h)	Imperial Gallon Per Minute (Imp. gal/min)	U.S Gallon Per Minute (US gal/min)
1	0.06	2.1189	0.22	0.2642
16.6667	1	35.3147	3.6662	4.4029
0.4719	0.0283	1	0.1038	0.1247
4.5461	0.2728	9.6326	1	1,2009
3.7854	0.2271	8.0208	0.8327	1

LENGTH

Millimetre (mm)	Centimetre (cm)	Metre (m)	Inch (in)	Foot (ft)
1	0.1	0.01	0.0394	0.0033
10	1	0.1	0.3937	0.0328
1000	100	1	39.37	3.2808
25.4	2.54	0.0254	1	0.0833
304.8	30.48	0.3048	12	1

TEMPERATURE

Water	Kelvin (K)	Celsius (°C)	Fahrenheit (°F)
Freezing	273.15	0	32
Boiling	373.15	100	212



HQ, Sales, Service & Manufacturing Centre

GM Treble Ltd
New Street
Parkfields
Wolverhampton
WV4 6AN

Tel: 01902 333111
sales@gmtreble.co.uk

Derby Sales & Service Office

GM Treble Ltd
Unit 3, Derby Trading Estate
Stores Road
Derby
DE21 4BE

Tel: 01332 294366
derbysales@gmtreble.co.uk

London Sales & Service Office

GM Treble Ltd
Unit 29, Sarum Complex
Salisbury Road
Uxbridge
UB8 2RZ

Tel: 01902 333111
londonsales@gmtreble.co.uk